



Chipsmall Limited consists of a professional team with an average of over 10 year of expertise in the distribution of electronic components. Based in Hongkong, we have already established firm and mutual-benefit business relationships with customers from,Europe,America and south Asia,supplying obsolete and hard-to-find components to meet their specific needs.

With the principle of “Quality Parts,Customers Priority,Honest Operation,and Considerate Service”,our business mainly focus on the distribution of electronic components. Line cards we deal with include Microchip,ALPS,ROHM,Xilinx,Pulse,ON,Everlight and Freescale. Main products comprise IC,Modules,Potentiometer,IC Socket,Relay,Connector.Our parts cover such applications as commercial,industrial, and automotives areas.

We are looking forward to setting up business relationship with you and hope to provide you with the best service and solution. Let us make a better world for our industry!



Contact us

Tel: +86-755-8981 8866 Fax: +86-755-8427 6832

Email & Skype: info@chipsmall.com Web: www.chipsmall.com

Address: A1208, Overseas Decoration Building, #122 Zhenhua RD., Futian, Shenzhen, China



GaAs MMIC DOUBLE-BALANCED MIXER, 6 - 20 GHz



Typical Applications

The HMC144LH5 is ideal for:

- Telecom Infrastructure
- Test Instrumentation
- Military Radio, Radar & ECM
- Space Systems

Features

- Input IP3: +24 dBm
- LO/RF Isolation: 35 dB
- IF Bandwidth: DC to 3 GHz
- RoHS Compliant Hermetic SMT Package, 25 mm²
- Screening to MIL-PRF-38535 (Class B or S) Available

Functional Diagram

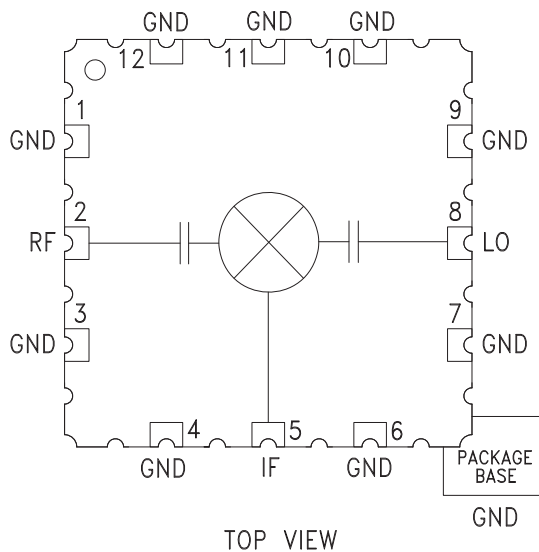

General Description

The HMC144LH5 is a Double-Balanced MMIC Mixer housed in a hermetic SMT leadless package which can be used as an upconverter or downconverter from 6 to 20 GHz. Broadband operation and excellent isolations are provided by on-chip baluns, while no external components or DC bias are required. The HMC144LH5 is a more reliable alternative to hybrid diode mixers, assuring consistent conversion loss and isolation performance over multiple production lots. The HMC144LH5 allows the use of surface mount manufacturing techniques and is suitable for high reliability, military, industrial and space applications.

Electrical Specifications, $T_A = +25^\circ\text{C}$

Parameter	IF = 100 MHz LO = +20 dBm						Units
	Min.	Typ.	Max.	Min.	Typ.	Max.	
Frequency Range, RF & LO	6 - 12			12 - 20			GHz
Frequency Range, IF	DC - 3			DC - 3			GHz
Conversion Loss		9.5	11.5		11	13	dB
Noise Figure (SSB)		9.5	11.5		11	13	dB
LO to RF Isolation	23	35		23	35		dB
LO to IF Isolation	10	20		10	20		dB
RF to IF Isolation	12	25		12	22		dB
IP3 (Input)		24			24		dBm
1 dB Compression (Input)	12	15		12	15		dBm

* Unless otherwise noted, all measurements performed as downconverter, IF= 100 MHz.



GaAs MMIC DOUBLE-BALANCED MIXER, 6 - 20 GHz

Conversion Gain vs. Temperature @ LO = +20 dBm

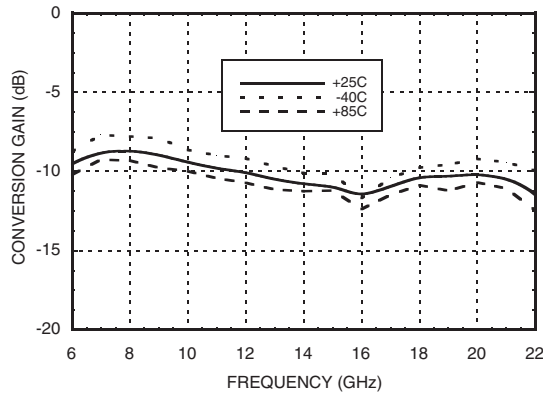

Isolation @ LO = +20 dBm

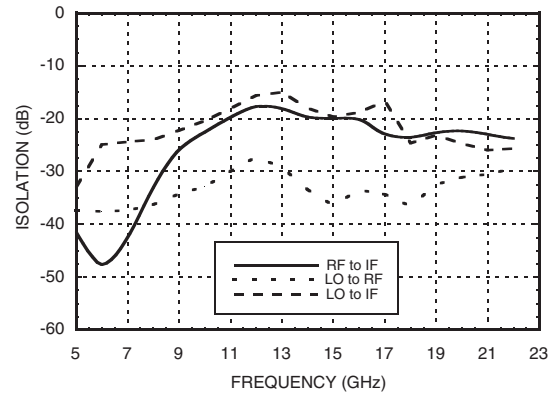

Conversion Gain vs. LO Drive

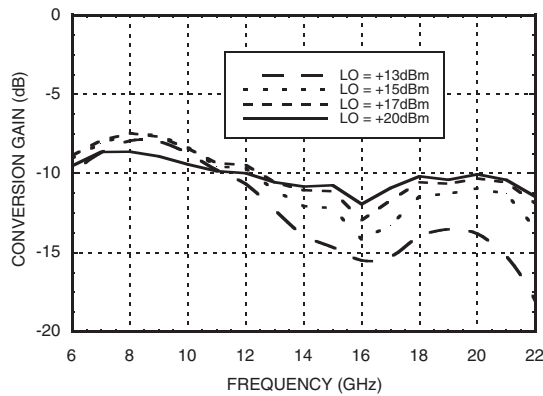

Return Loss @ LO = +20 dBm

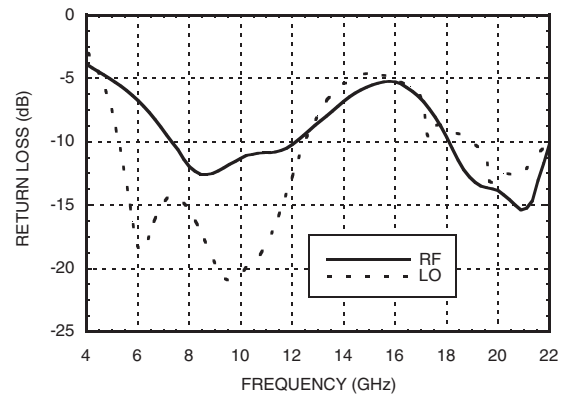

IF Bandwidth @ LO = +20 dBm

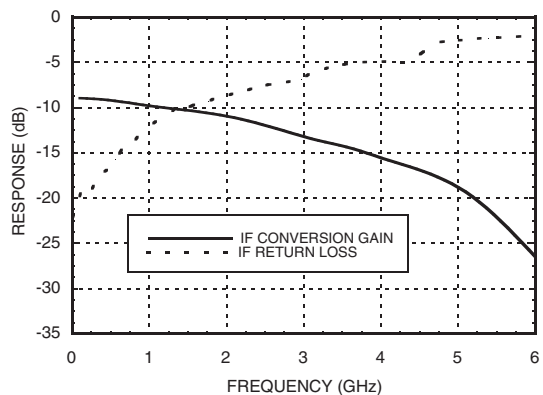

Upconverter Performance Conversion Gain @ LO = +20 dBm

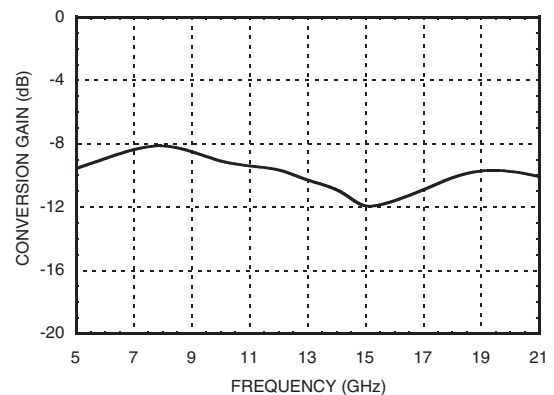

Information furnished by Analog Devices is believed to be accurate and reliable. However, no responsibility is assumed by Analog Devices for its use, nor for any infringements of patents or other rights of third parties that may result from its use. Specifications subject to change without notice. No license is granted by implication or otherwise under any patent or patent rights of Analog Devices. Trademarks and registered trademarks are the property of their respective owners.

For price, delivery, and to place orders: Analog Devices, Inc., One Technology Way, P.O. Box 9106, Norwood, MA 02062-9106 Phone: 781-329-4700 • Order online at www.analog.com Application Support: Phone: 1-800-ANALOG-D



GaAs MMIC DOUBLE-BALANCED MIXER, 6 - 20 GHz

Input IP3 vs. LO Drive*

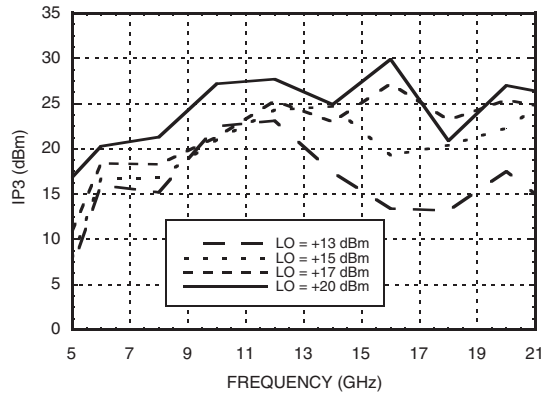

Input IP3 vs. Temperature @ LO = +20 dBm*

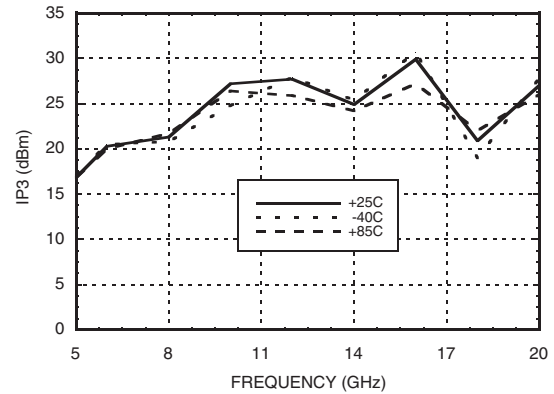

Input IP2 vs. LO Drive *

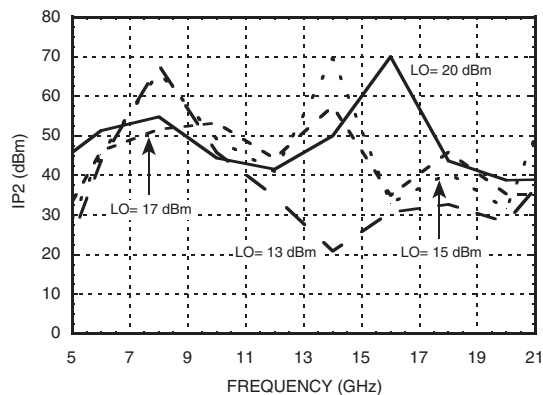

Input P1dB vs. Temperature @ LO = +20 dBm

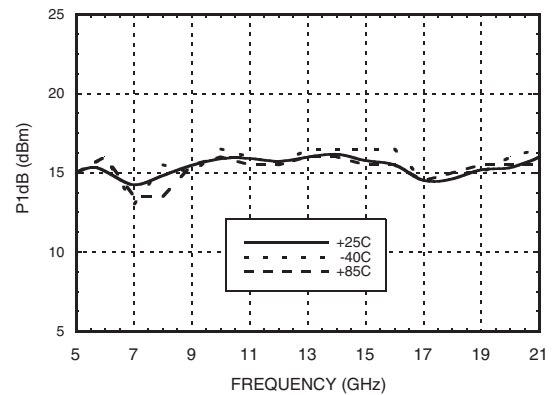

MxN Spurious @ IF Port

mRF	nLO				
	0	1	2	3	4
0	XX	-23	18	2	23
1	8	0	25	14	37
2	65	65	62	80	62
3	85	86	83	90	82
4	86	87	95	100	105

RF = 12 GHz @ -10 dBm
 LO = 12.1 GHz @ 20 dBm
 All values in dBc relative to the IF power level.
 Measured as downconverter.

Harmonics of LO

LO Freq. (GHz)	nLO Spur @ RF Port			
	1	2	3	4
6	37	34	56	46
8	36	38	61	50
10	33	43	66	63
12	27	37	48	60
14	35	41	50	N/A
16	34	42	58	N/A
18	35	55	N/A	N/A
20	30	54	N/A	N/A

LO = +20 dBm
 All values in dBc below input LO level @ RF port.

* Two-tone input power = 0 dBm each tone, 1 MHz spacing.

GaAs MMIC DOUBLE-BALANCED MIXER, 6 - 20 GHz



Absolute Maximum Ratings

RF / IF Input	+15 dBm
LO Drive	+27 dBm
IF DC Current	±2 mA
Channel Temperature	150 °C
Continuous P _{diss} (T = 85 °C) (derate 9.83 mW/°C above 85 °C)	640 mW
Thermal Resistance (R _{TH}) (Channel to package bottom)	101.7 °C/W
Storage Temperature	-65 to +150 °C
Operating Temperature	-40 to +85 °C
ESD Sensitivity (HBM)	Class 1A



ELECTROSTATIC SENSITIVE DEVICE
OBSERVE HANDLING PRECAUTIONS

Outline Drawing

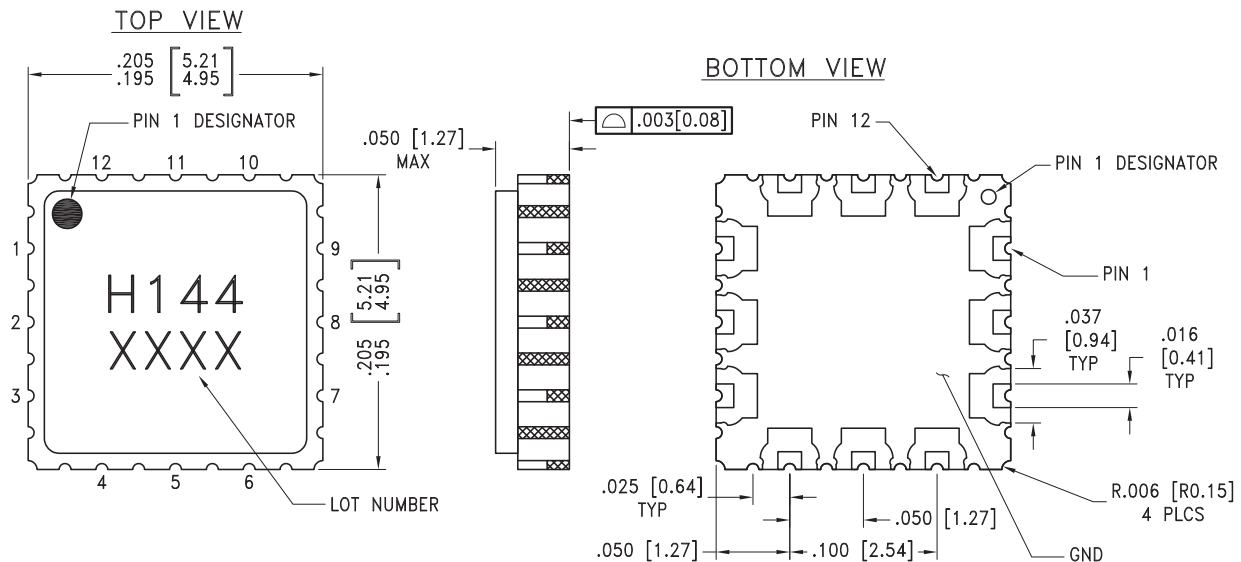

NOTES:

1. PACKAGE BODY MATERIAL: CERAMIC & KOVAR
2. LEAD AND GROUND PADDLE PLATING: GOLD 40-80 MICROINCHES
3. DIMENSIONS ARE IN INCHES [MILLIMETERS].
4. LEAD SPACING TOLERANCE IS NON-CUMULATIVE.
5. PAD BURR LENGTH 0.15mm MAX. PAD BURR HEIGHT 0.25mm MAX
6. ALL GROUND LEADS AND GROUND PADDLE MUST BE SOLDERED TO PCB RF GROUND.

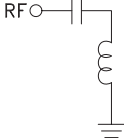
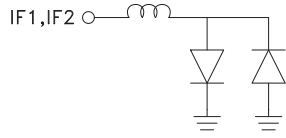
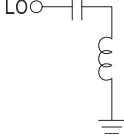

Pin Descriptions

Pin Number	Function	Description	Interface Schematic
1, 3, 4, 6, 7, 9-12	GND	These pins and package bottom must be connect to RF/DC ground.	
2	RF	This pin is AC coupled and matched to 50 Ohms.	
5	IF	This pin is DC coupled. For applications not requiring operation to DC, this port should be DC blocked externally using a series capacitor whose value has been chosen to pass the necessary IF frequency range. For operation to DC, this pin must not source/sink more than 2 mA of current or die non-function and possible die failure will result.	
8	LO	This pin is AC coupled and matched to 50 Ohms.	

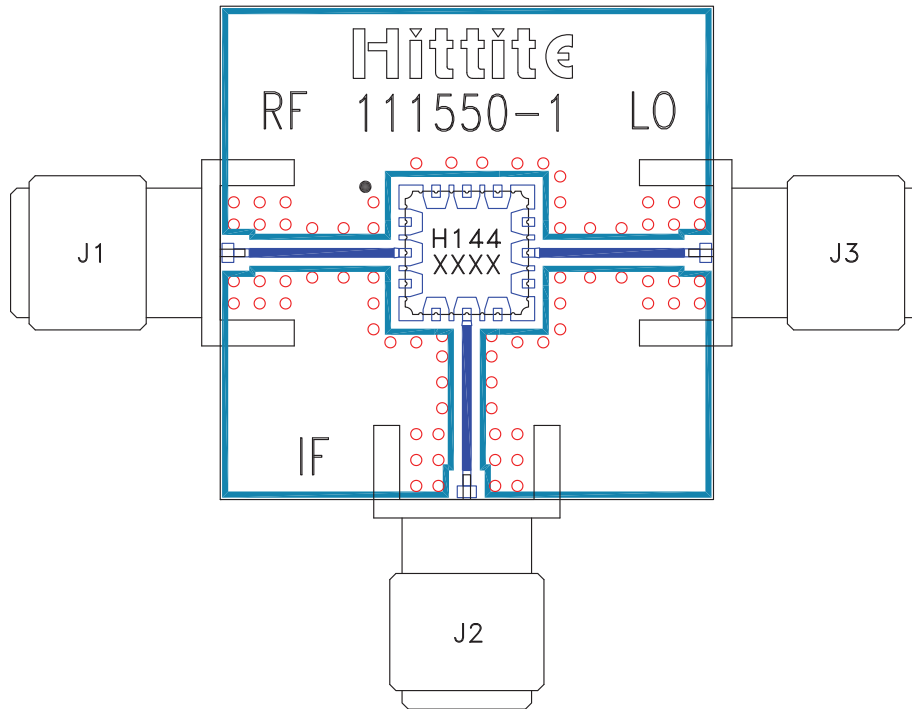

**GaAs MMIC DOUBLE-BALANCED
MIXER, 6 - 20 GHz**

Evaluation PCB



List of Materials for Evaluation PCB 116588 [1]

Item	Description
J1 - J3	PCB Mount SMA RF Connector, SRI
U1	HMC144LH5
PCB [2]	111550 Evaluation Board

[1] Reference this number when ordering complete evaluation PCB

[2] Circuit Board Material: Rogers 4350

The circuit board used in the final application should use RF circuit design techniques. Signal lines should have 50 ohm impedance while the package ground leads and exposed paddle should be connected directly to the ground plane similar to that shown. A sufficient number of via holes should be used to connect the top and bottom ground planes. The evaluation circuit board shown is available from Hittite upon request.