



Chipsmall Limited consists of a professional team with an average of over 10 year of expertise in the distribution of electronic components. Based in Hongkong, we have already established firm and mutual-benefit business relationships with customers from,Europe,America and south Asia,supplying obsolete and hard-to-find components to meet their specific needs.

With the principle of “Quality Parts,Customers Priority,Honest Operation,and Considerate Service”,our business mainly focus on the distribution of electronic components. Line cards we deal with include Microchip,ALPS,ROHM,Xilinx,Pulse,ON,Everlight and Freescale. Main products comprise IC,Modules,Potentiometer,IC Socket,Relay,Connector.Our parts cover such applications as commercial,industrial, and automotives areas.

We are looking forward to setting up business relationship with you and hope to provide you with the best service and solution. Let us make a better world for our industry!



Contact us

Tel: +86-755-8981 8866 Fax: +86-755-8427 6832

Email & Skype: info@chipsmall.com Web: www.chipsmall.com

Address: A1208, Overseas Decoration Building, #122 Zhenhua RD., Futian, Shenzhen, China



GaAs MMIC SUB-HARMONICALLY PUMPED MIXER, 20 - 32 GHz

Typical Applications

The HMC264 is ideal for:

- Microwave Point-to-Point Radios
- LMDS
- SATCOM

Features

- Integrated LO Amplifier: -4 dBm Input
- Sub-Harmonically Pumped (x2) LO
- High 2LO/RF Isolation: 40 dB
- Small Size: 1.32 x 0.97 x 0.1 mm

Functional Diagram

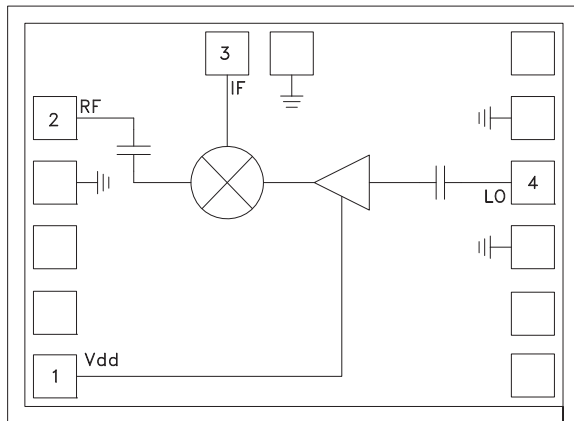

General Description

The HMC264 chip is a sub-harmonically pumped (x2) MMIC mixer with an integrated LO amplifier which can be used as an upconverter or downconverter. The chip utilizes a GaAs PHEMT technology that results in a small overall chip area of 1.28mm². The 2LO to RF isolation is excellent eliminating the need for additional filtering. The LO amplifier is a single bias (+3V to +4V) two stage design with only -4 dBm nominal drive requirement. All data is measured with the chip in a 50 ohm test fixture connected via 0.025 mm (1 mil) diameter wire bonds of minimal length <0.31 mm (<12 mils).

Electrical Specifications, $T_A = +25^\circ \text{C}$, As a Function of LO Drive & Vdd

Parameter	IF = 1 GHz LO = 0 dBm & Vdd = +4V			IF = 1 GHz LO = -4 dBm & Vdd = +4V			IF = 1 GHz LO = -4 dBm & Vdd = +3V			Units
	Min.	Typ.	Max.	Min.	Typ.	Max.	Min.	Typ.	Max.	
Frequency Range, RF	24 - 32			20 - 30			22 - 29			GHz
Frequency Range, LO	12 - 16			10 - 15			10.5 - 14.5			GHz
Frequency Range, IF	DC - 6			DC - 6			DC - 4			GHz
Conversion Loss		10	13		10	12		9	11	dB
Noise Figure (SSB)		10	13		10	12		9	11	dB
2LO to RF Isolation	29	35		29	40		18	22 - 30		dB
2LO to IF Isolation	32	40		29	40 ~ 50		25	30		dB
IP3 (Input)	5	13		5	13		3	10		dBm
1 dB Gain Compression (Input)	+3	+6		-3	0 ~ +4		-5	0 ~ +3		dBm
Supply Current (Idd)		28	50		28	50		25	50	mA

GaAs MMIC SUB-HARMONICALLY PUMPED MIXER, 20 - 32 GHz

Conversion Gain vs. Temperature @ LO = -4 dBm, Vdd = +4V

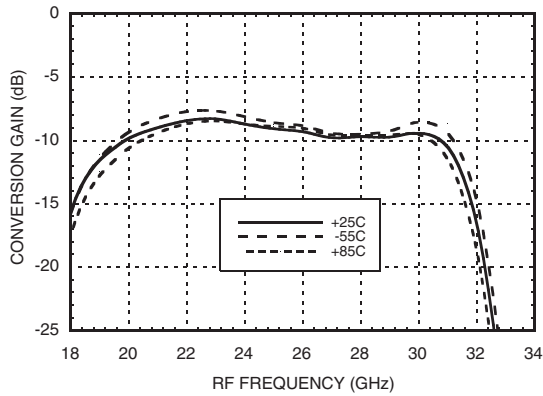

Conversion Gain vs. Temperature @ LO = -4 dBm, Vdd = +3V

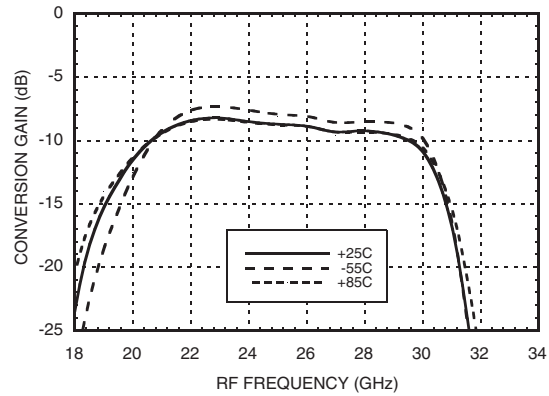

Conversion Gain vs. LO Drive @ Vdd = +4V

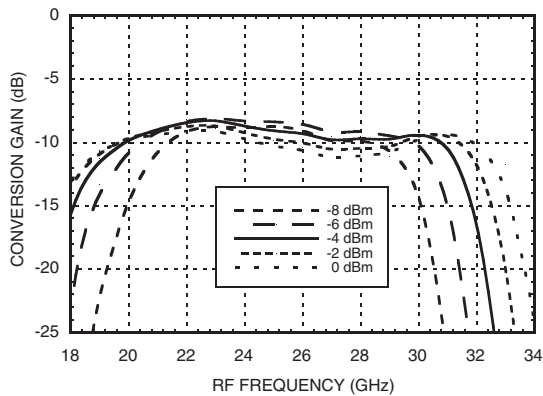

Conversion Gain vs. LO Drive @ Vdd = +3V

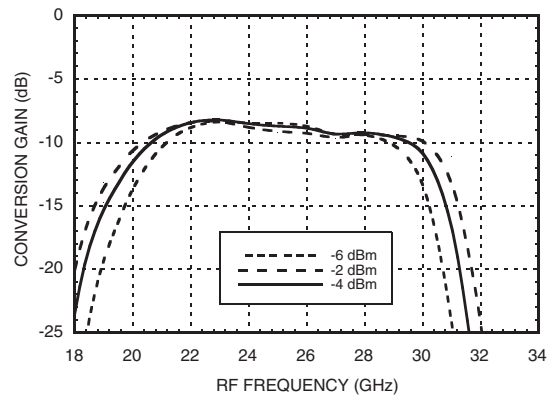

Isolation @ LO = -4 dBm, Vdd = +4V

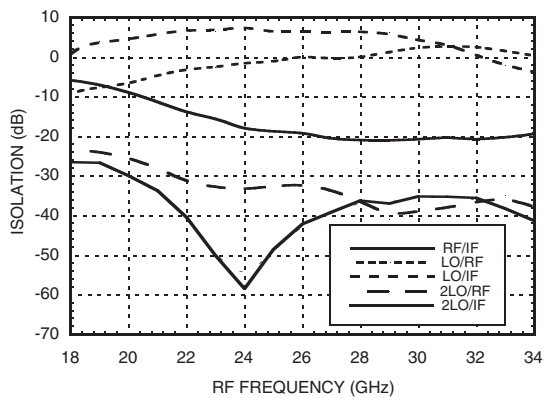

Isolation @ LO = -4 dBm, Vdd = +3V

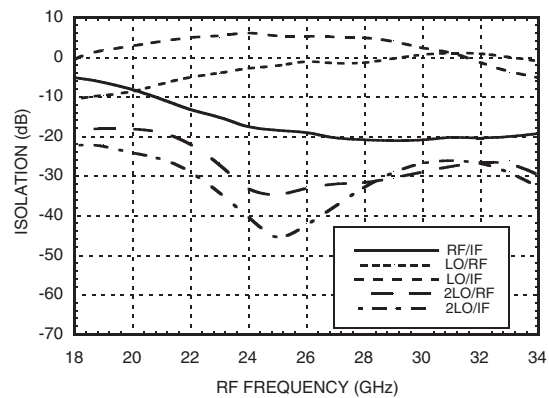

Information furnished by Analog Devices is believed to be accurate and reliable. However, no responsibility is assumed by Analog Devices for its use, nor for any infringements of patents or other rights of third parties that may result from its use. Specifications subject to change without notice. No license is granted by implication or otherwise under any patent or patent rights of Analog Devices. Trademarks and registered trademarks are the property of their respective owners.

For price, delivery, and to place orders: Analog Devices, Inc., One Technology Way, P.O. Box 9106, Norwood, MA 02062-9106 Phone: 781-329-4700 • Order online at www.analog.com Application Support: Phone: 1-800-ANALOG-D

GaAs MMIC SUB-HARMONICALLY PUMPED MIXER, 20 - 32 GHz

Input IP3 vs. LO Drive @ Vdd = +4V

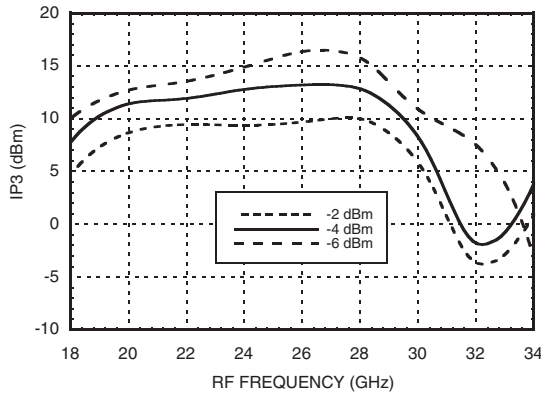

Input IP3 vs. LO Drive @ Vdd = +3V

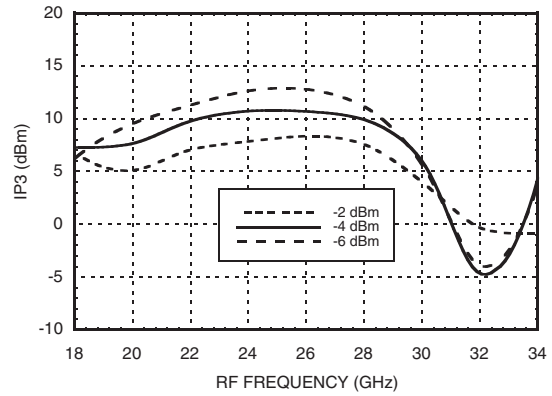

Input IP3 vs. Temperature @ LO = -4 dBm, Vdd = +4V

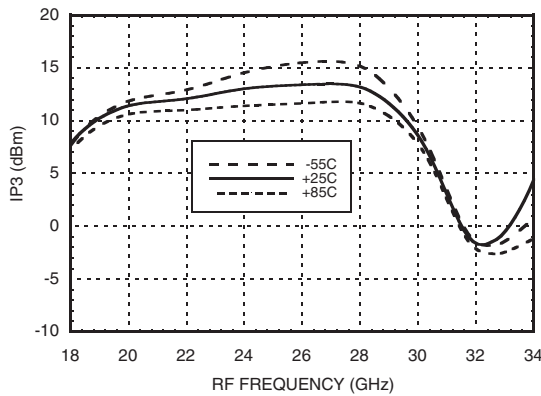

Input IP3 vs. Temperature @ LO = -4 dBm, Vdd = +3V

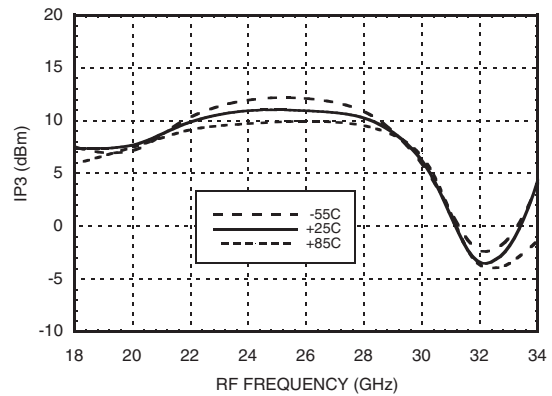

Input IP2 vs. LO Drive @ Vdd = +4V

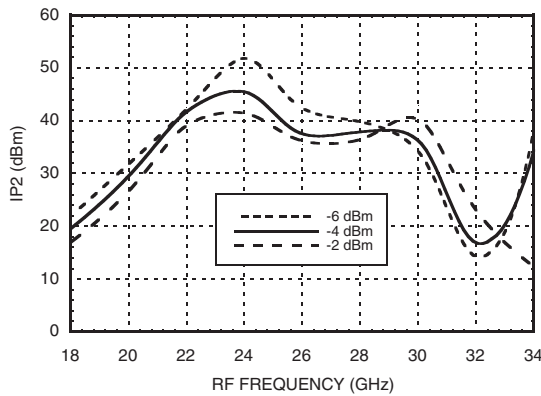

Input IP2 vs. LO Drive @ Vdd = +3V

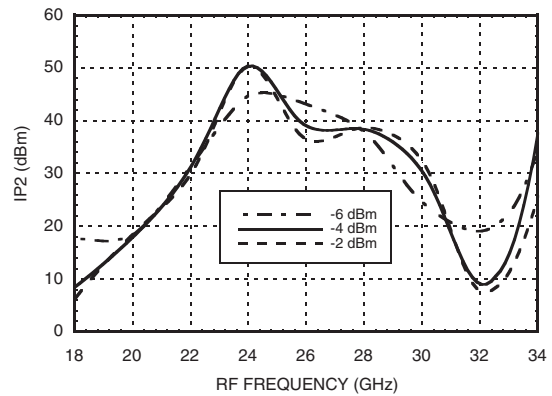

Information furnished by Analog Devices is believed to be accurate and reliable. However, no responsibility is assumed by Analog Devices for its use, nor for any infringements of patents or other rights of third parties that may result from its use. Specifications subject to change without notice. No license is granted by implication or otherwise under any patent or patent rights of Analog Devices. Trademarks and registered trademarks are the property of their respective owners.

For price, delivery, and to place orders: Analog Devices, Inc., One Technology Way, P.O. Box 9106, Norwood, MA 02062-9106 Phone: 781-329-4700 • Order online at www.analog.com Application Support: Phone: 1-800-ANALOG-D

**GaAs MMIC SUB-HARMONICALLY
PUMPED MIXER, 20 - 32 GHz**

**Input IP2 vs.
Temperature @ LO = -4 dBm, Vdd = +4V**

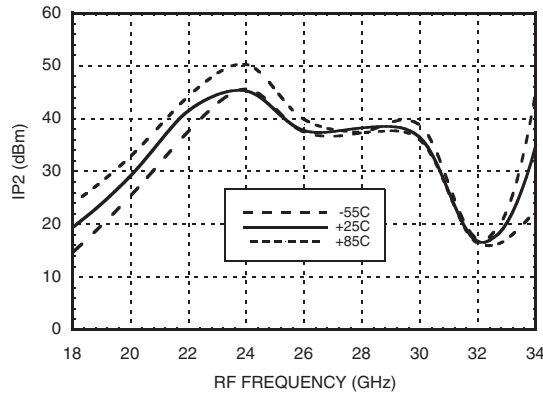

**Input IP2 vs.
Temperature @ LO = -4 dBm, Vdd = +3V**

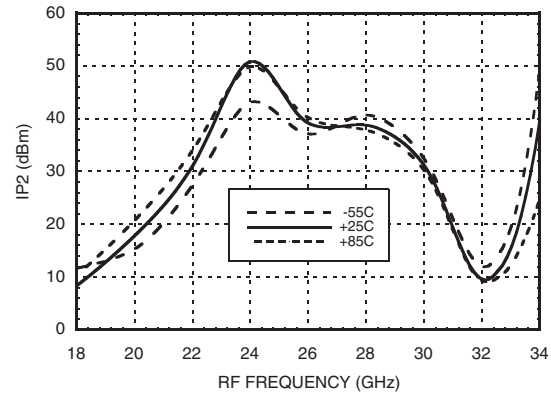

**Input P1dB vs.
Temperature @ LO = -4 dBm, Vdd = +4V**

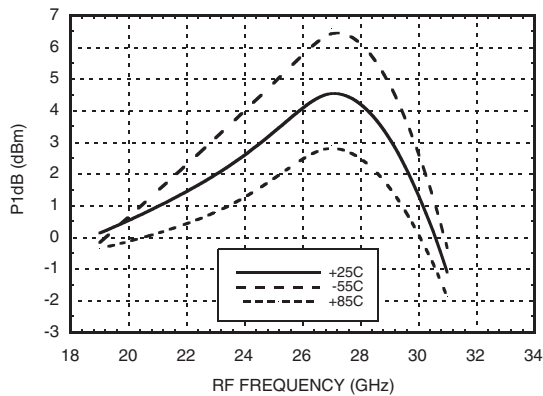

**Input P1dB vs.
Temperature @ LO = -4 dBm, Vdd = +3V**

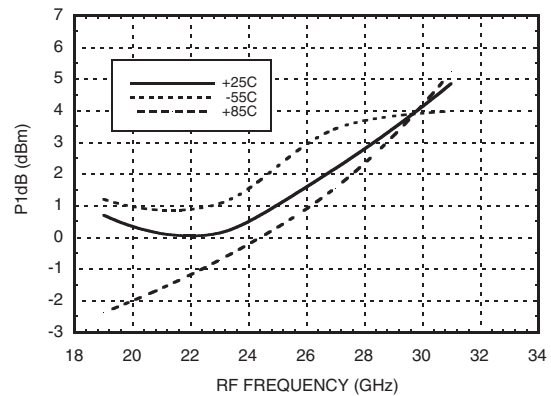

Information furnished by Analog Devices is believed to be accurate and reliable. However, no responsibility is assumed by Analog Devices for its use, nor for any infringements of patents or other rights of third parties that may result from its use. Specifications subject to change without notice. No license is granted by implication or otherwise under any patent or patent rights of Analog Devices. Trademarks and registered trademarks are the property of their respective owners.

For price, delivery, and to place orders: Analog Devices, Inc., One Technology Way, P.O. Box 9106, Norwood, MA 02062-9106 Phone: 781-329-4700 • Order online at www.analog.com Application Support: Phone: 1-800-ANALOG-D

**GaAs MMIC SUB-HARMONICALLY
PUMPED MIXER, 20 - 32 GHz**

**Upconverter Performance
Conversion Gain, LO = -4 dBm**

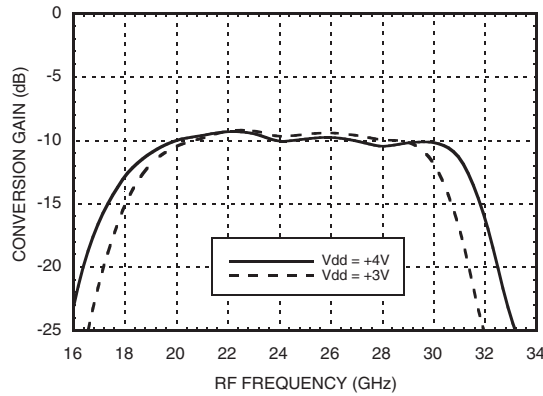

Return Loss @ LO = -4 dBm, Vdd = +4V

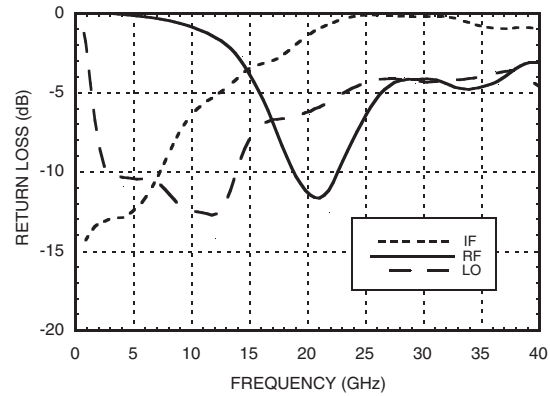

IF Bandwidth @ LO = -4 dBm, Vdd = +4V

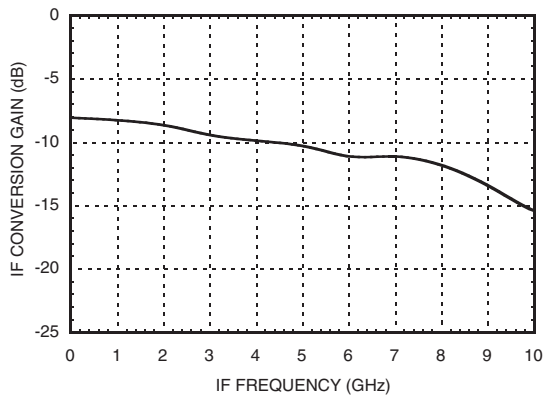

**MxN Spurious Outputs
@ LO Drive = -4 dBm, Vdd = +4V**

	nLO					
mRF	±5	±4	±3	±2	±1	0
-3						
-2	-36					
-1	-54	-22	-34			
0				-15	+26	
1				x	-30	-10
2		-54	-38	-66		
3	-74	-67				

RF = 30 GHz @ -10 dBm
LO = 13.5 GHz @ -4 dBm
All values in dBc below the IF power level

Information furnished by Analog Devices is believed to be accurate and reliable. However, no responsibility is assumed by Analog Devices for its use, nor for any infringements of patents or other rights of third parties that may result from its use. Specifications subject to change without notice. No license is granted by implication or otherwise under any patent or patent rights of Analog Devices. Trademarks and registered trademarks are the property of their respective owners.

For price, delivery, and to place orders: Analog Devices, Inc., One Technology Way, P.O. Box 9106, Norwood, MA 02062-9106 Phone: 781-329-4700 • Order online at www.analog.com Application Support: Phone: 1-800-ANALOG-D

GaAs MMIC SUB-HARMONICALLY PUMPED MIXER, 20 - 32 GHz

Absolute Maximum Ratings

RF / IF Input (Vdd = +4V)	+13 dBm
LO Drive (Vdd = +4V)	+13 dBm
Vdd	+5.5 Vdc
Storage Temperature	-65 to +150 °C
Operating Temperature	-55 to +85 °C







ELECTROSTATIC SENSITIVE DEVICE
OBSERVE HANDLING PRECAUTIONS

3

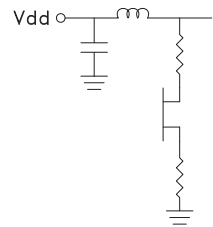
MIXERS - SUB-HARMONIC - CHIP

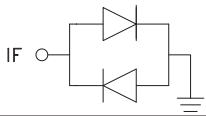
Pad Descriptions

Pad Number	Function	Description	Interface Schematic
1	Vdd	Power supply for the LO Amplifier. An external RF bypass capacitor of 100 - 330 pF is required. A MIM border capacitor is recommended. The bond length to the capacitor should be as short as possible. The ground side of the capacitor should be connected to the housing ground.	
2	RF	This pad is AC coupled and matched to 50 Ohm.	
3	IF	This pad is DC coupled and should be DC blocked externally using a series capacitor whose value has been chosen to pass the necessary IF frequency range. Any applied DC voltage to this pin will result in die non-function and possible die failure.	
4	LO	This pad is AC coupled and matched to 50 Ohm.	

**GaAs MMIC SUB-HARMONICALLY
PUMPED MIXER, 20 - 32 GHz**

Outline Drawing

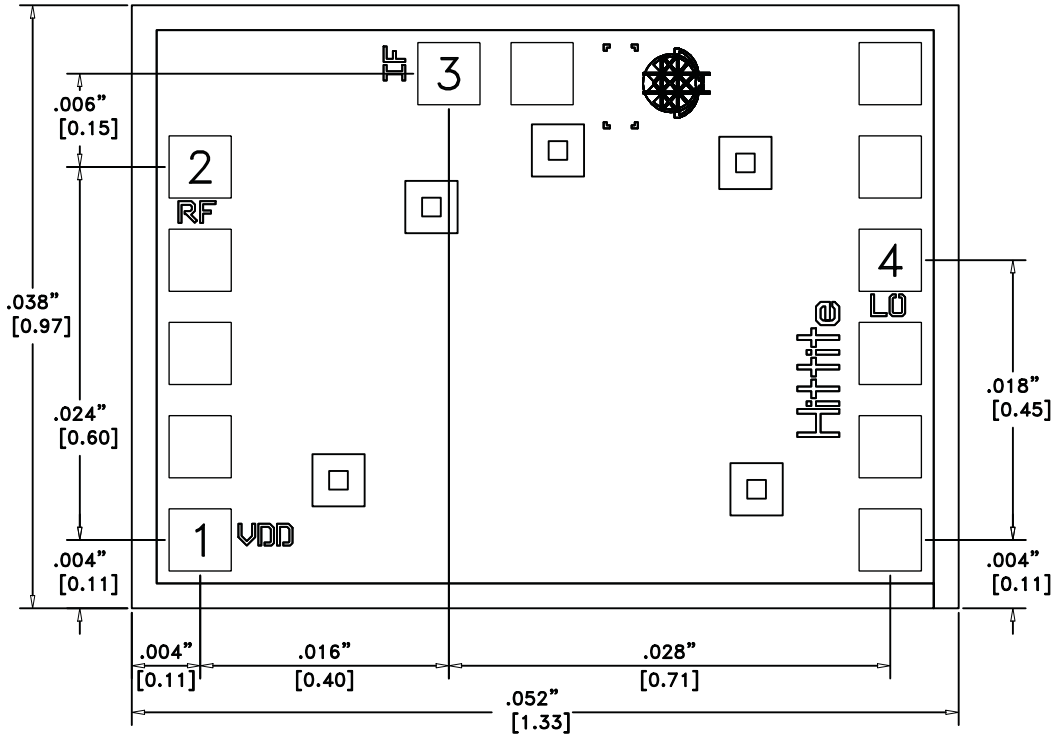

Die Packaging Information ^[1]

Standard	Alternate
GP-2 (Gel Pack)	[2]

[1] Refer to the "Packaging Information" section for die packaging dimensions.

[2] For alternate packaging information contact Hittite Microwave Corporation.

NOTES:

1. ALL DIMENSIONS ARE IN INCHES [MM].
2. DIE THICKNESS IS .004".
3. TYPICAL BOND PAD IS .004" SQUARE.
4. BOND PAD SPACING CENTER TO CENTER IS .006".
5. BACKSIDE METALLIZATION: GOLD.
6. BOND PAD METALLIZATION: GOLD.
7. BACKSIDE METAL IS GROUND.
8. CONNECTION NOT REQUIRED FOR UNLABELED BOND PADS.

GaAs MMIC SUB-HARMONICALLY PUMPED MIXER, 20 - 32 GHz

Mounting & Bonding Techniques for Millimeterwave GaAs MMICs

The die should be attached directly to the ground plane eutectically or with conductive epoxy (see HMC general Handling, Mounting, Bonding Note).

50 Ohm Microstrip transmission lines on 0.127mm (5 mil) thick alumina thin film substrates are recommended for bringing RF to and from the chip (Figure 1). If 0.254mm (10 mil) thick alumina thin film substrates must be used, the die should be raised 0.150mm (6 mils) so that the surface of the die is coplanar with the surface of the substrate. One way to accomplish this is to attach the 0.102mm (4 mil) thick die to a 0.150mm (6 mil) thick molybdenum heat spreader (moly-tab) which is then attached to the ground plane (Figure 2).

Microstrip substrates should be brought as close to the die as possible in order to minimize bond wire length. Typical die-to-substrate spacing is 0.076mm (3 mils).

An RF bypass capacitor should be used on the Vdd input. A 100 pF single layer capacitor (mounted eutectically or by conductive epoxy) placed no further than 0.762mm (30 Mils) from the chip is recommended. The photo in figure 3 shows a typical assembly for the HMC264 MMIC chip.

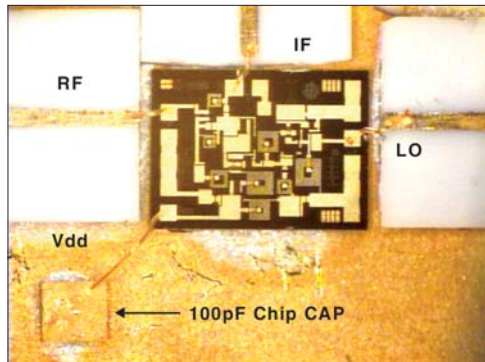
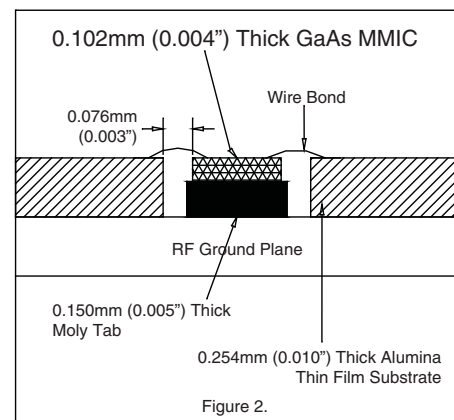
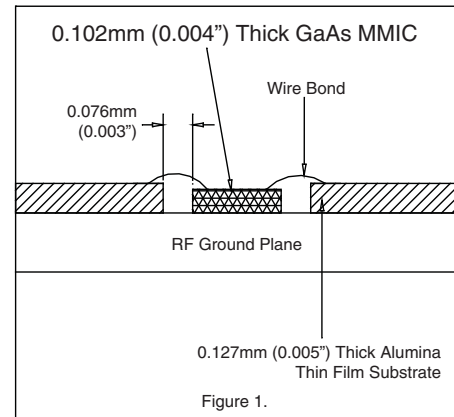

Figure 3: Typical HMC264 Assembly



Handling Precautions

Follow these precautions to avoid permanent damage.

Storage: All bare die are placed in either Waffle or Gel based ESD protective containers, and then sealed in an ESD protective bag for shipment. Once the sealed ESD protective bag has been opened, all die should be stored in a dry nitrogen environment.

Cleanliness: Handle the chips in a clean environment. DO NOT attempt to clean the chip using liquid cleaning systems.

Static Sensitivity: Follow ESD precautions to protect against ESD strikes.

Transients: Suppress instrument and bias supply transients while bias is applied. Use shielded signal and bias cables to minimize inductive pick-up.

General Handling: Handle the chip along the edges with a vacuum collet or with a sharp pair of bent tweezers. The surface of the chip has fragile air bridges and should not be touched with vacuum collet, tweezers, or fingers.

Mounting

The chip is back-metallized and can be die mounted with AuSn eutectic preforms or with electrically conductive epoxy. The mounting surface should be clean and flat.

Eutectic Die Attach: A 80/20 gold tin preform is recommended with a work surface temperature of 255 °C and a tool temperature of 265 °C. When hot 90/10 nitrogen/hydrogen gas is applied, tool tip temperature should be 290 °C. DO NOT expose the chip to a temperature greater than 320 °C for more than 20 seconds. No more than 3 seconds of scrubbing should be required for attachment.

Epoxy Die Attach: Apply a minimum amount of epoxy to the mounting surface so that a thin epoxy fillet is observed around the perimeter of the chip once it is placed into position. Cure epoxy per the manufacturer's schedule.

Wire Bonding

Ball or wedge bond with 0.025 mm (1 mil) diameter pure gold wire. Thermosonic wirebonding with a nominal stage temperature of 150 °C and a ball bonding force of 40 to 50 grams or wedge bonding force of 18 to 22 grams is recommended. Use the minimum level of ultrasonic energy to achieve reliable wirebonds. Wirebonds should be started on the chip and terminated on the package or substrate. All bonds should be as short as possible <0.31 mm (12 mils).

Information furnished by Analog Devices is believed to be accurate and reliable. However, no responsibility is assumed by Analog Devices for its use, nor for any infringements of patents or other rights of third parties that may result from its use. Specifications subject to change without notice. No license is granted by implication or otherwise under any patent or patent rights of Analog Devices. Trademarks and registered trademarks are the property of their respective owners.

For price, delivery, and to place orders: Analog Devices, Inc., One Technology Way, P.O. Box 9106, Norwood, MA 02062-9106 Phone: 781-329-4700 • Order online at www.analog.com Application Support: Phone: 1-800-ANALOG-D