



Chipsmall Limited consists of a professional team with an average of over 10 year of expertise in the distribution of electronic components. Based in Hongkong, we have already established firm and mutual-benefit business relationships with customers from,Europe,America and south Asia,supplying obsolete and hard-to-find components to meet their specific needs.

With the principle of “Quality Parts,Customers Priority,Honest Operation,and Considerate Service”,our business mainly focus on the distribution of electronic components. Line cards we deal with include Microchip,ALPS,ROHM,Xilinx,Pulse,ON,Everlight and Freescale. Main products comprise IC,Modules,Potentiometer,IC Socket,Relay,Connector.Our parts cover such applications as commercial,industrial, and automotives areas.

We are looking forward to setting up business relationship with you and hope to provide you with the best service and solution. Let us make a better world for our industry!



Contact us

Tel: +86-755-8981 8866 Fax: +86-755-8427 6832

Email & Skype: info@chipsmall.com Web: www.chipsmall.com

Address: A1208, Overseas Decoration Building, #122 Zhenhua RD., Futian, Shenzhen, China





GaAs MMIC SUB-HARMONIC SMT MIXER, 21 - 31 GHz

Typical Applications

The HMC264LC3B is ideal for:

- Point-to-Point Radios
- Point-to-Multi-Point Radios & VSAT
- Test Equipment & Sensors
- Military End-Use

Features

- Integrated LO Amplifier: -4 to +4 dBm Input
- Sub-Harmonically Pumped (x2) LO
- High 2LO/RF Isolation: 30 dB
- DC - 6 GHz Wideband IF
- 12 Lead 3x3mm SMT Package: 9mm²

Functional Diagram

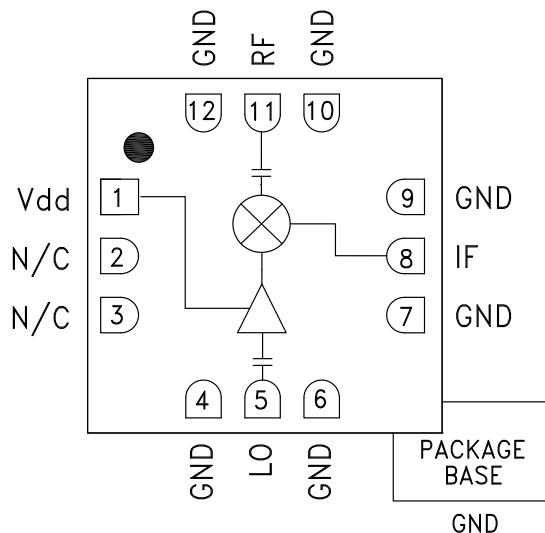

General Description

The HMC264LC3B is a 21 - 31 GHz Sub-harmonically Pumped (x2) MMIC Mixer with an integrated LO amplifier in a leadless "Pb Free" SMT package. The 2LO to RF isolation is excellent at 30 dB, eliminating the need for additional filtering. The LO amplifier is a single bias (+3V to +4V) design with only -4 to +4 dBm drive requirement. The RF and LO ports are DC blocked and matched to 50 Ohms for ease of use while the IF covers DC to 6 GHz. The HMC264LC3B eliminates the need for wire bonding, allowing use of surface mount manufacturing techniques.

Electrical Specifications, $T_A = +25^\circ\text{C}$, As a Function of LO Drive & Vdd

| Parameter | IF = 1 GHz LO = -4 dBm & Vdd = +4V | | | IF = 1 GHz LO = -4 dBm & Vdd = +3V | | | Units |
|-----------------------------------|---------------------------------------|------|------|---------------------------------------|------|------|-------|
| | Min. | Typ. | Max. | Min. | Typ. | Max. | |
| Frequency Range, RF | 21 - 31 | | | 22 - 31 | | | GHz |
| Frequency Range, LO | 10.5 - 15.5 | | | 11 - 15.5 | | | GHz |
| Frequency Range, IF | DC - 6 | | | DC - 6 | | | GHz |
| Conversion Loss | | 9 | 12 | | 9 | 12 | dB |
| Noise Figure (SSB) | | 9 | 12 | | 9 | 12 | dB |
| 2LO to RF Isolation | 20 | 30 | | 18 | 30 | | dB |
| 2LO to IF Isolation | 25 | 40 | | 25 | 40 | | dB |
| IP3 (Input) | | 12 | | | 10 | | dBm |
| 1 dB Compression (Input) | | +3 | | | +1 | | dBm |
| Supply Current (I _{dd}) | | 28 | | | 25 | | mA |

*Unless otherwise noted, all measurements performed as downconverter, IF = 1 GHz.

HMC264LC3B* PRODUCT PAGE QUICK LINKS

Last Content Update: 02/23/2017

COMPARABLE PARTS

View a parametric search of comparable parts.

EVALUATION KITS

- HMC264LC3B Evaluation Board

DOCUMENTATION

Application Notes

- Mixer Application Note

Data Sheet

- HMC264LC3B Data Sheet

TOOLS AND SIMULATIONS

- HMC264LC3B S-Parameters

REFERENCE MATERIALS

Quality Documentation

- Package/Assembly Qualification Test Report: LC3, LC3B, LC3C (QTR: 2014-00376 REV: 01)
- Semiconductor Qualification Test Report: PHEMT-A (QTR: 2013-00267)

DESIGN RESOURCES

- HMC264LC3B Material Declaration
- PCN-PDN Information
- Quality And Reliability
- Symbols and Footprints

DISCUSSIONS

View all HMC264LC3B EngineerZone Discussions.

SAMPLE AND BUY

Visit the product page to see pricing options.

TECHNICAL SUPPORT

Submit a technical question or find your regional support number.

DOCUMENT FEEDBACK

Submit feedback for this data sheet.



GaAs MMIC SUB-HARMONIC SMT MIXER, 21 - 31 GHz

Conversion Gain vs. Temperature @ LO = -4 dBm, Vdd = +4V

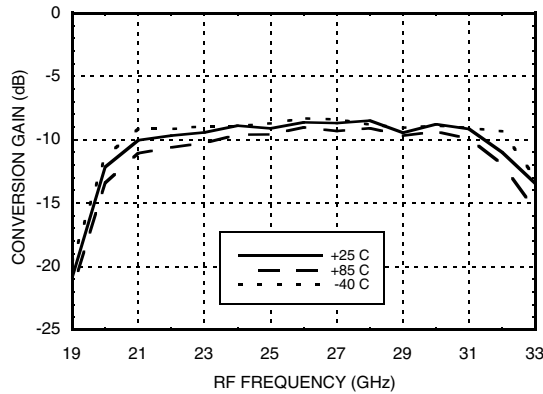

Conversion Gain vs. Temperature @ LO = -4 dBm, Vdd = +3V

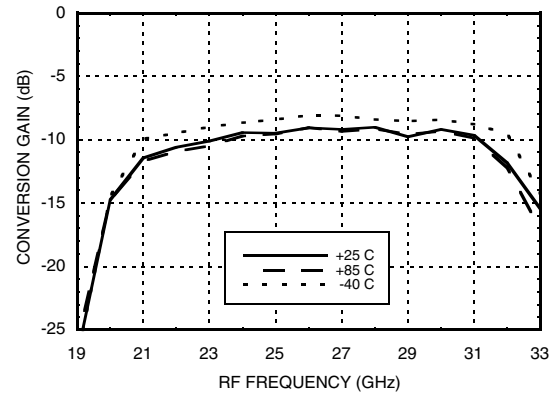

Conversion Gain vs. LO Drive @ Vdd = +4V

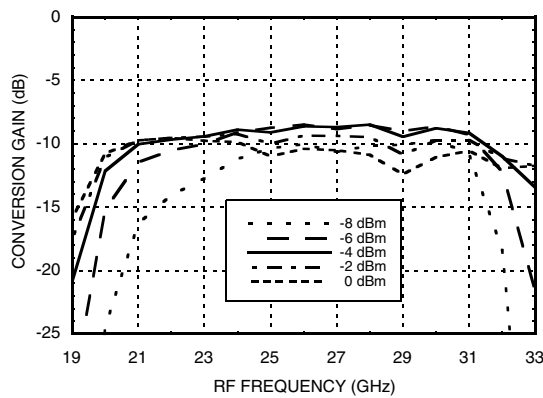

Conversion Gain vs. LO Drive @ Vdd = +3V

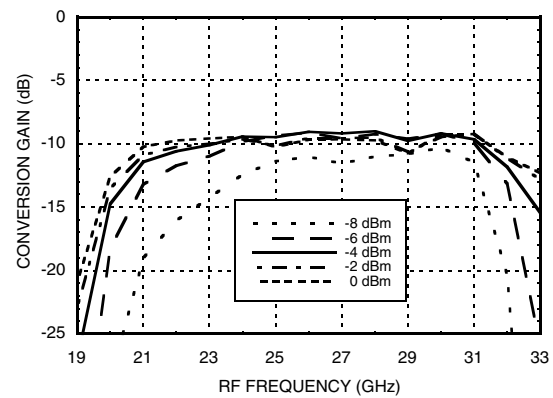

Isolation @ LO = -4 dBm, Vdd = +4V

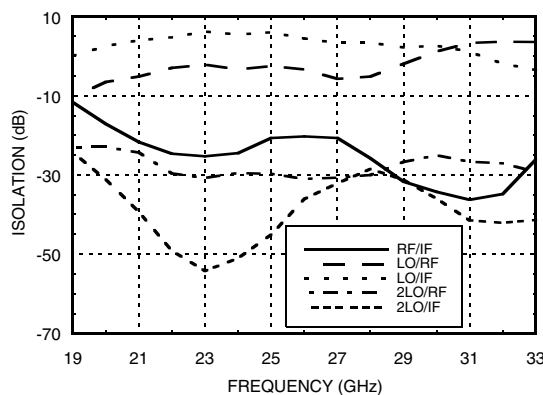

Isolation @ LO = -4 dBm, Vdd = +3V

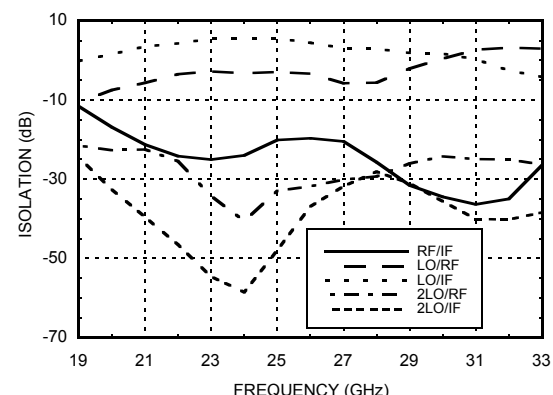



GaAs MMIC SUB-HARMONIC SMT MIXER, 21 - 31 GHz

Input IP3 vs. LO Drive @ Vdd = +4V *

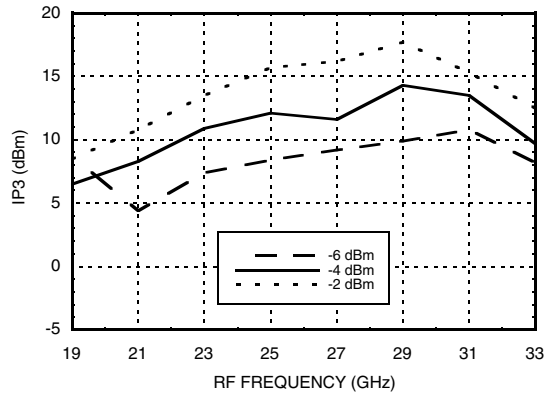

Input IP3 vs. LO Drive @ Vdd = +3V *

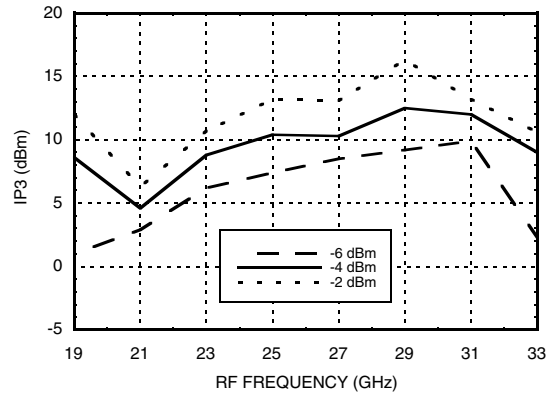

Input IP2 vs. LO Drive @ Vdd = +4V *

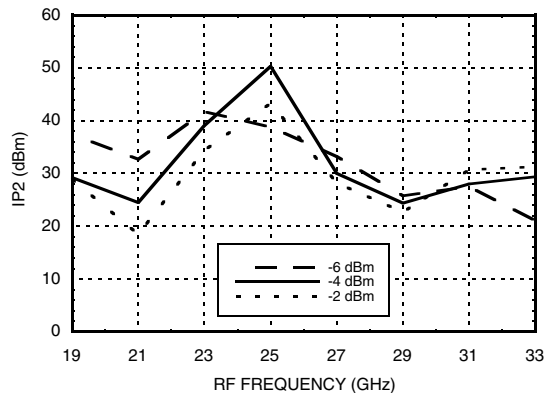

Input IP2 vs. LO Drive @ Vdd = +3V *

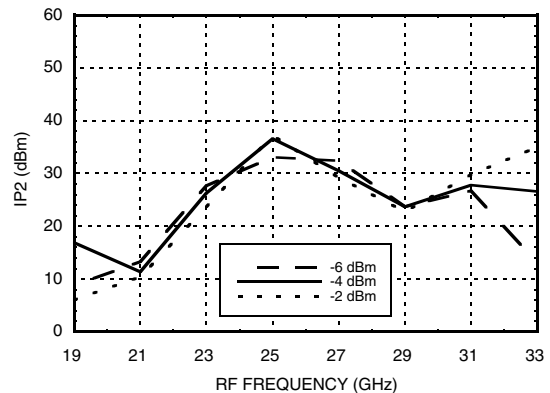

Input P1dB vs. Temperature @ LO = -4 dBm, Vdd = +4V

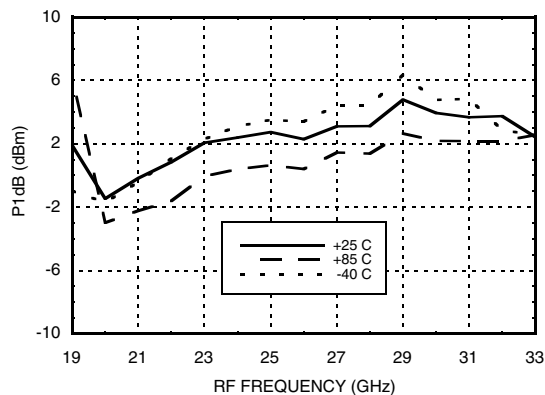

Input P1dB vs. Temperature @ LO = -4 dBm, Vdd = +3V

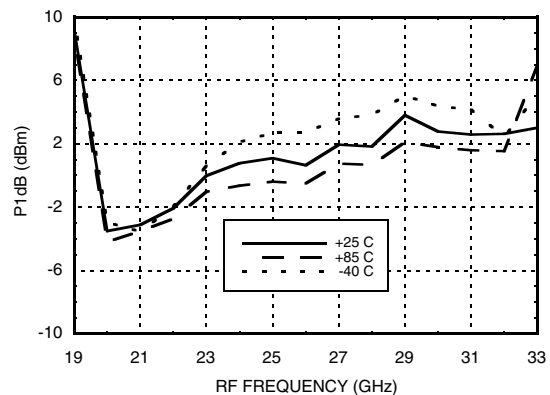

* Two-tone input power = -10 dBm each tone, 1 MHz spacing.



GaAs MMIC SUB-HARMONIC SMT MIXER, 21 - 31 GHz

**Upconverter Performance
Conversion Gain @ LO = -4 dBm**

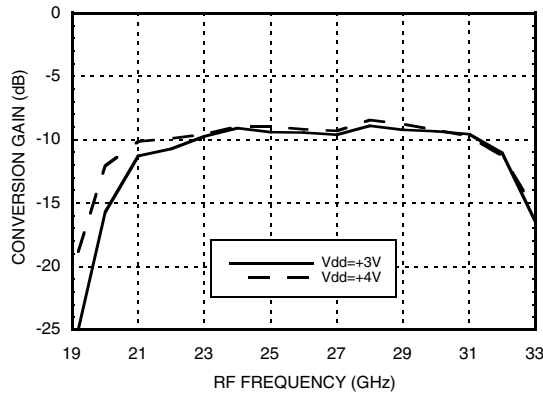

IF Bandwidth @ LO = -4 dBm

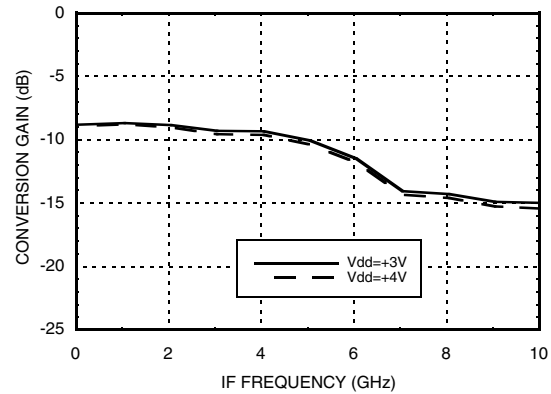

RF & LO Return Loss @ LO = -4 dBm

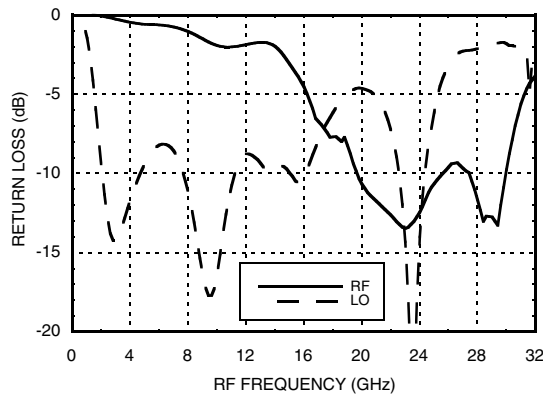

IF Return Loss @ LO = -4 dBm

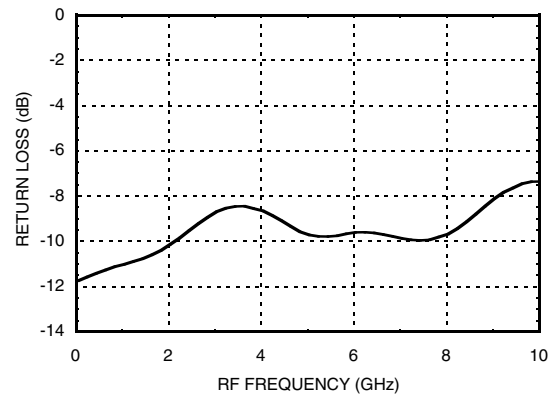

**MxN Spurious Outputs
@ LO = -4 dBm, Vdd = +4V**

| mRF | nLO | | | | | |
|-----|-----|----|----|----|-----|----|
| | ±5 | ±4 | ±3 | ±2 | ±1 | 0 |
| -2 | 30 | | | | | |
| -1 | 60 | 39 | 31 | | | |
| 0 | | | 17 | 14 | -17 | |
| 1 | | | | X | 35 | 25 |
| 2 | | 46 | 42 | 64 | 64 | |
| 3 | 82 | 80 | 82 | | | |

RF = 30 GHz @ -10 dBm
LO = 13.5 GHz @ -4 dBm
All values in dBc below IF power level.



GaAs MMIC SUB-HARMONIC SMT MIXER, 21 - 31 GHz

Absolute Maximum Ratings

| | |
|--|----------------|
| RF / IF Input (Vdd = +5V) | +13 dBm |
| LO Drive (Vdd = +5V) | +13 dBm |
| Vdd | 5.5V |
| Channel Temperature | 175 °C |
| Continuous P _{diss} (Ta = 85 °C) (derate 2.52 mW/°C above 85 °C) | 227 mW |
| Thermal Resistance (junction to ground paddle) | 397 °C/W |
| Storage Temperature | -65 to +150 °C |
| Operating Temperature | -40 to +85 °C |



ELECTROSTATIC SENSITIVE DEVICE
OBSERVE HANDLING PRECAUTIONS

Outline Drawing

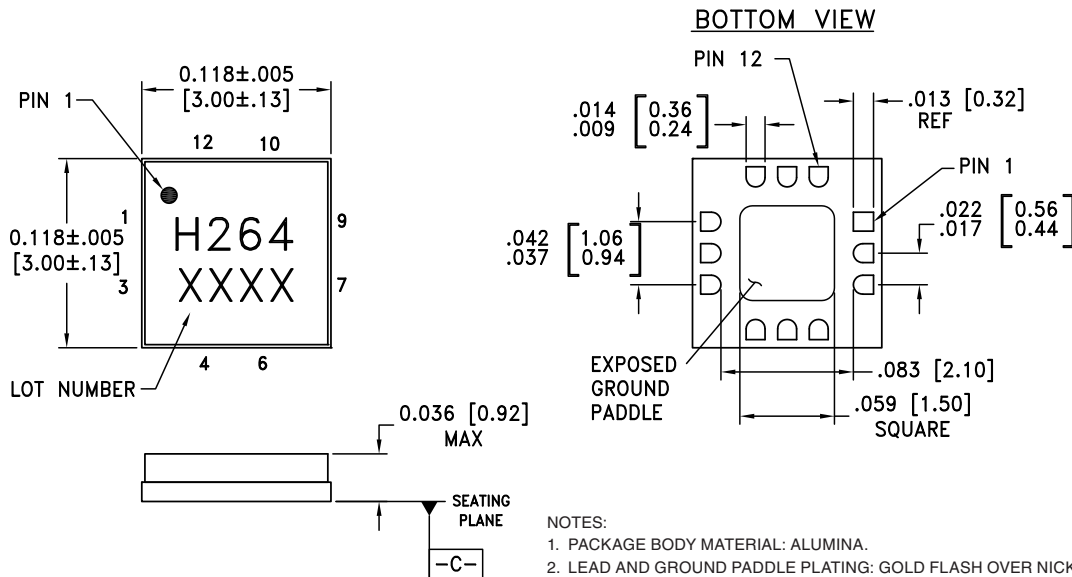

- NOTES:
1. PACKAGE BODY MATERIAL: ALUMINA.
 2. LEAD AND GROUND PADDLE PLATING: GOLD FLASH OVER NICKEL.
 3. DIMENSIONS ARE IN INCHES (MILLIMETERS).
 4. LEAD SPACING TOLERANCE IS NON-CUMULATIVE.
 5. CHARACTERS TO BE HELVETICA MEDIUM, .025 HIGH, BLACK INK, OR LASER MARK LOCATED APPROX. AS SHOWN.
 6. PACKAGE WARP SHALL NOT EXCEED 0.05MM DATUM $\overline{-C-}$
 7. ALL GROUND LEADS AND GROUND PADDLE MUST BE SOLDERED TO PCB RF GROUND.

Package Information

| Part Number | Package Body Material | Lead Finish | MSL Rating | Package Marking ^[2] |
|-------------|-----------------------|------------------|---------------------|--------------------------------|
| HMC264LC3B | Alumina, White | Gold over Nickel | MSL3 ^[1] | H264 XXXX |

[1] Max peak reflow temperature of 260 °C

[2] 4-Digit lot number XXXX

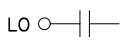
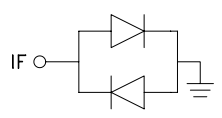
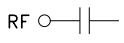

**GaAs MMIC SUB-HARMONIC
SMT MIXER, 21 - 31 GHz**
Pin Descriptions

| Pin Number | Function | Description | Interface Schematic |
|--------------------|----------|---|---|
| 1 | Vdd | Power supply for the LO Amplifier. External RF bypass capacitors are required as close to the package as possible. | |
| 2, 3 | N/C | No connection required. These pins may be connected to RF/DC ground without affecting performance. | |
| 4, 6, 7, 9, 10, 12 | GND | Package bottom must also be connected to RF/DC ground. |  |
| 5 | LO | LO Port. This pin is AC coupled and matched to 50 Ohms from 10.5 - 15.5 GHz. |  |
| 8 | IF | IF Port. This pin is DC coupled and should be DC blocked externally using a series capacitor whose value has been chosen to pass the necessary IF frequency range. Any applied DC voltage to this pin will result in die non-function and possible die failure. |  |
| 11 | RF | RF Port. This pin is AC coupled and matched to 50 Ohms from 21 - 31 GHz. |  |

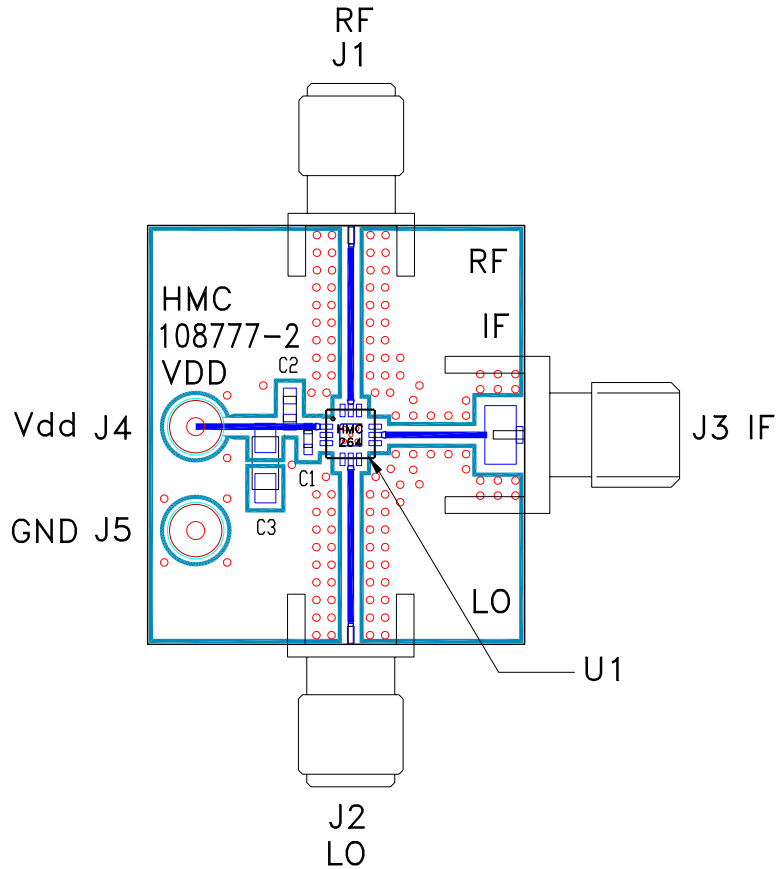

**GaAs MMIC SUB-HARMONIC
SMT MIXER, 21 - 31 GHz**

Evaluation PCB



List of Materials for Evaluation PCB 108779 [1]

| Item | Description |
|---------|-----------------------------|
| J1 - J3 | PCB Mount SMA Connector |
| J4, J5 | DC Pin |
| C1 | 100 pF Capacitor, 0402 Pkg. |
| C2 | 1000 pF Capacitor, 0603 Pkg |
| C3 | 2.2 μF Capacitor, Tantalum |
| U1 | HMC264LC3B Mixer |
| PCB [2] | 108777 Evaluation PCB |

[1] Reference this number when ordering complete evaluation PCB

[2] Circuit Board Material: Rogers 4350

The circuit board used in this application should use RF circuit design techniques. Signal lines should have 50 Ohm impedance while the package ground leads and exposed paddle should be connected directly to the ground plane similar to that shown. A sufficient number of via holes should be used to connect the top and bottom ground planes. The evaluation board should be mounted to an appropriate heat sink. The evaluation circuit board shown is available from Hittite upon request.

**GaAs MMIC SUB-HARMONIC
SMT MIXER, 21 - 31 GHz**