



Chipsmall Limited consists of a professional team with an average of over 10 year of expertise in the distribution of electronic components. Based in Hongkong, we have already established firm and mutual-benefit business relationships with customers from,Europe,America and south Asia,supplying obsolete and hard-to-find components to meet their specific needs.

With the principle of "Quality Parts,Customers Priority,Honest Operation,and Considerate Service",our business mainly focus on the distribution of electronic components. Line cards we deal with include Microchip,ALPS,ROHM,Xilinx,Pulse,ON,Everlight and Freescale. Main products comprise IC,Modules,Potentiometer,IC Socket,Relay,Connector.Our parts cover such applications as commercial,industrial, and automotives areas.

We are looking forward to setting up business relationship with you and hope to provide you with the best service and solution. Let us make a better world for our industry!



Contact us

Tel: +86-755-8981 8866 Fax: +86-755-8427 6832

Email & Skype: info@chipsmall.com Web: www.chipsmall.com

Address: A1208, Overseas Decoration Building, #122 Zhenhua RD., Futian, Shenzhen, China





InGaP HBT GAIN BLOCK MMIC AMPLIFIER, DC - 6 GHz

Typical Applications

The HMC311LP3(E) is ideal for:

- Cellular / PCS / 3G
- Fixed Wireless & WLAN
- CATV & Cable Modem
- Microwave Radio

Features

- P1dB Output Power: +15.5 dBm
- Output IP3: +32 dBm
- Gain: 14.5 dB
- 50 Ohm I/O's
- 16 Lead 3x3mm SMT Package: 9mm²

Functional Diagram

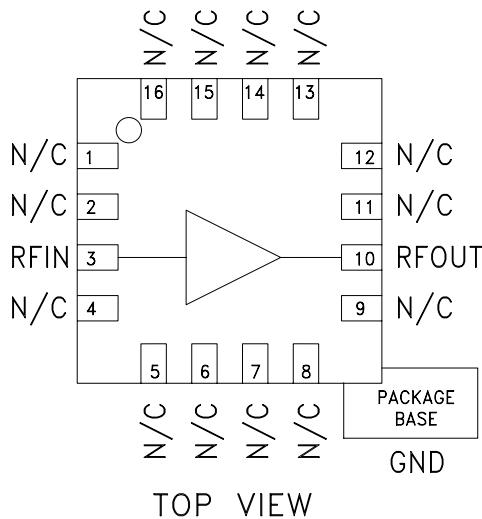

General Description

The HMC311LP3(E) is a GaAs InGaP Heterojunction Bipolar Transistor (HBT) Gain Block MMIC SMT DC to 6 GHz amplifiers. This 3x3mm QFN packaged amplifier can be used as either a cascadable 50 Ohm gain stage or to drive the LO of HMC mixers with up to +17 dBm output power. The HMC311LP3(E) offers 14.5 dB of gain and an output IP3 of +32 dBm while requiring only 56 mA from a +5V supply. The Darlington feedback pair used results in reduced sensitivity to normal process variations and yields excellent gain stability over temperature while requiring a minimal number of external bias components.

Electrical Specifications, Vs= 5V, Rbias= 22 Ohm, TA = +25° C

Parameter		Min.	Typ.	Max.	Units
Gain	DC - 1.0 GHz	13.0	14.5		dB
	1.0 - 4.0 GHz	12.5	14.3		dB
	4.0 - 6.0 GHz	12.0	14.0		dB
Gain Variation Over Temperature	DC - 2.0 GHz		0.005	0.008	dB/ °C
	2.0 - 4.0 GHz		0.008	0.012	dB/ °C
	4.0 - 6.0 GHz		0.012	0.016	dB/ °C
Return Loss Input / Output	DC - 1.0 GHz		13		dB
	1.0 - 3.0 GHz		11		dB
	3.0 - 6.0 GHz		15		dB
Reverse Isolation	DC - 6 GHz		18		dB
Output Power for 1 dB Compression (P1dB)	DC - 2.0 GHz	13.5	15.5		dBm
	2.0 - 4.0 GHz	12.0	15.0		dBm
	4.0 - 6.0 GHz	10.0	13.0		dBm
Output Third Order Intercept (IP3)	DC - 1.0 GHz		32		dBm
	1.0 - 2.0 GHz		30		dBm
	2.0 - 4.0 GHz		28		dBm
	4.0 - 6.0 GHz		24		dBm
Noise Figure	DC - 6 GHz		4.5		dB
Supply Current (Icq)			55	74	mA

Note: Data taken with broadband bias tee on device output.

Information furnished by Analog Devices is believed to be accurate and reliable. However, no responsibility is assumed by Analog Devices for its use, nor for any infringements of patents or other rights of third parties that may result from its use. Specifications subject to change without notice. No license is granted by implication or otherwise under any patent or patent rights of Analog Devices. Trademarks and registered trademarks are the property of their respective owners.

For price, delivery, and to place orders: Analog Devices, Inc., One Technology Way, P.O. Box 9106, Norwood, MA 02062-9106 Phone: 781-329-4700 • Order online at www.analog.com Application Support: Phone: 1-800-ANALOG-D

HMC311LP3* PRODUCT PAGE QUICK LINKS

Last Content Update: 02/23/2017

COMPARABLE PARTS

View a parametric search of comparable parts.

EVALUATION KITS

- HMC311LP3 Evaluation Board

DOCUMENTATION

Application Notes

- AN-1363: Meeting Biasing Requirements of Externally Biased RF/Microwave Amplifiers with Active Bias Controllers
- Broadband Biasing of Amplifiers General Application Note
- MMIC Amplifier Biasing Procedure Application Note
- Thermal Management for Surface Mount Components General Application Note

Data Sheet

- HMC311LP3 Data Sheet

TOOLS AND SIMULATIONS

- HMC311LP3 S-Parameters

REFERENCE MATERIALS

Quality Documentation

- Package/Assembly Qualification Test Report: LP2, LP2C, LP3, LP3B, LP3C, LP3D, LP3F, LP3G (QTR: 2014-0364)
- Semiconductor Qualification Test Report: GaAs HBT-B (QTR: 2013-00229)

DESIGN RESOURCES

- HMC311LP3 Material Declaration
- PCN-PDN Information
- Quality And Reliability
- Symbols and Footprints

DISCUSSIONS

View all HMC311LP3 EngineerZone Discussions.

SAMPLE AND BUY

Visit the product page to see pricing options.

TECHNICAL SUPPORT

Submit a technical question or find your regional support number.

DOCUMENT FEEDBACK

Submit feedback for this data sheet.



**InGaP HBT GAIN BLOCK
MMIC AMPLIFIER, DC - 6 GHz**

Gain & Return Loss

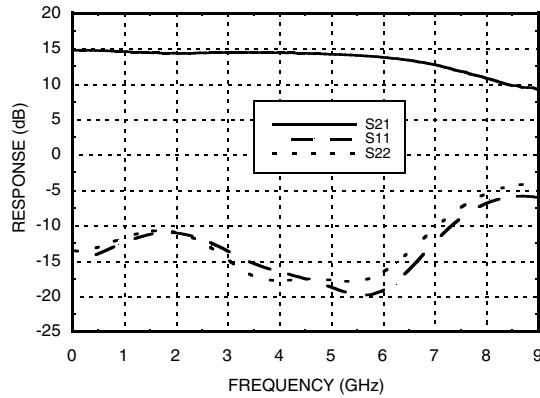

Gain vs. Temperature

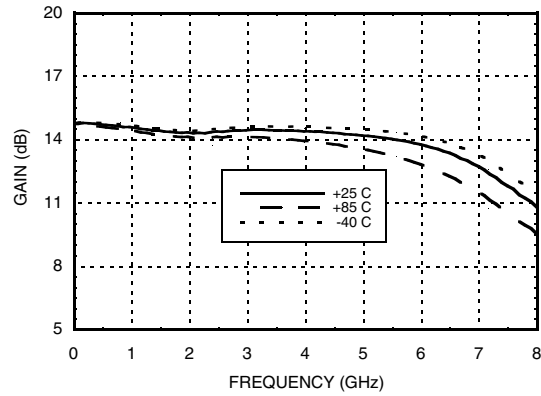

Input Return Loss vs. Temperature

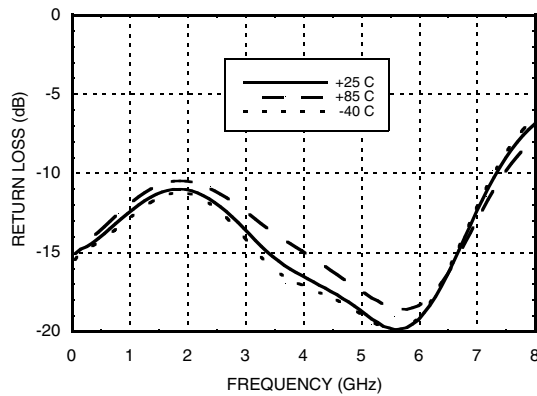

Output Return Loss vs. Temperature

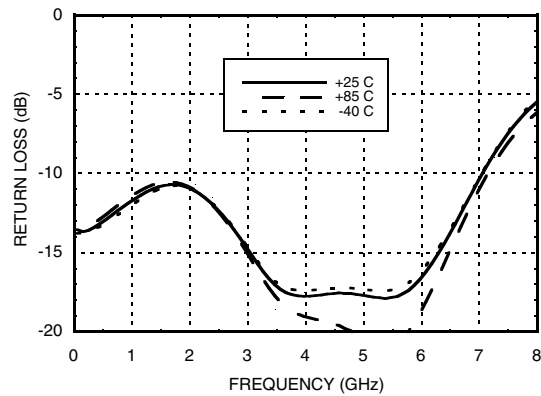

Reverse Isolation vs. Temperature

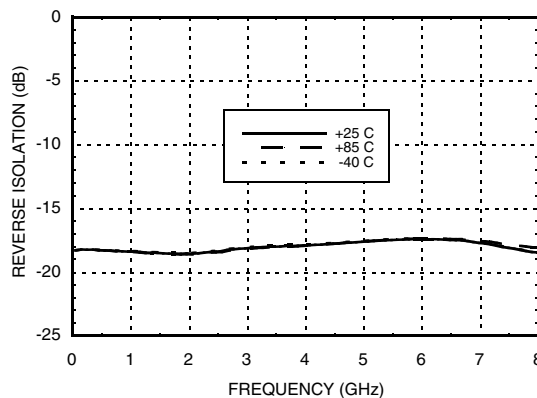

Noise Figure vs. Temperature

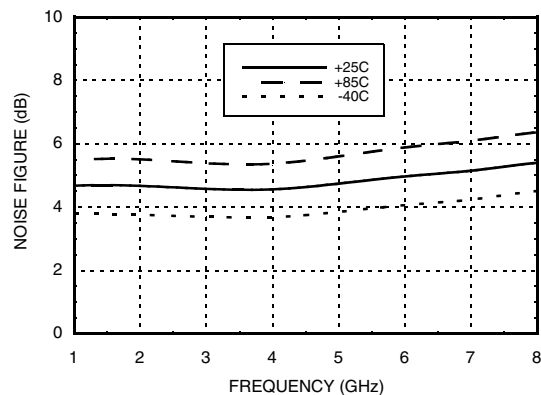

Information furnished by Analog Devices is believed to be accurate and reliable. However, no responsibility is assumed by Analog Devices for its use, nor for any infringements of patents or other rights of third parties that may result from its use. Specifications subject to change without notice. No license is granted by implication or otherwise under any patent or patent rights of Analog Devices. Trademarks and registered trademarks are the property of their respective owners.

For price, delivery, and to place orders: Analog Devices, Inc., One Technology Way, P.O. Box 9106, Norwood, MA 02062-9106 Phone: 781-329-4700 • Order online at www.analog.com Application Support: Phone: 1-800-ANALOG-D



HMC311LP3 / 311LP3E

InGaP HBT GAIN BLOCK MMIC AMPLIFIER, DC - 6 GHz

DRIVER & GAIN BLOCK AMPLIFIERS - SMT

P1dB vs. Temperature

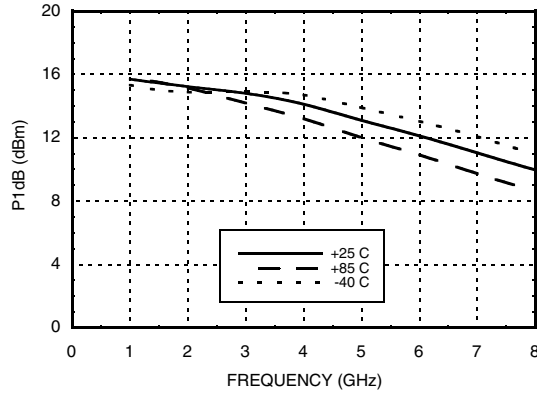

Psat vs. Temperature

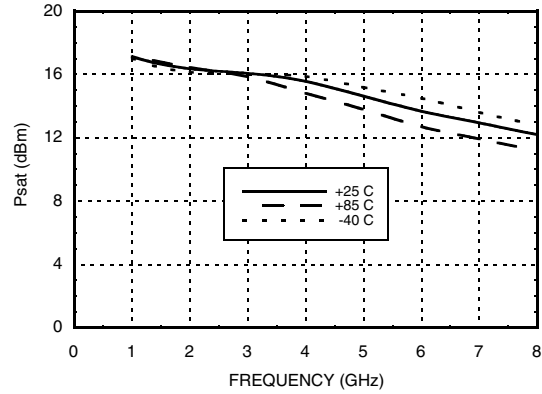

Power Compression @ 1 GHz

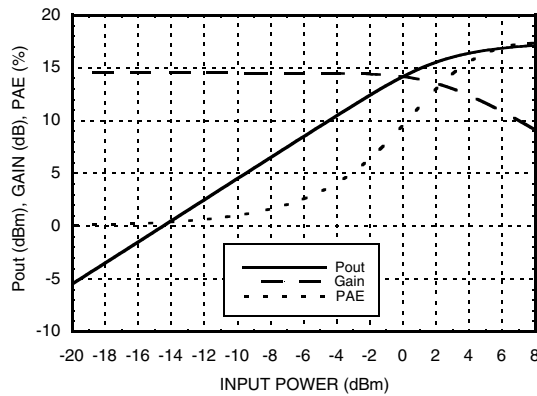

Power Compression @ 6 GHz

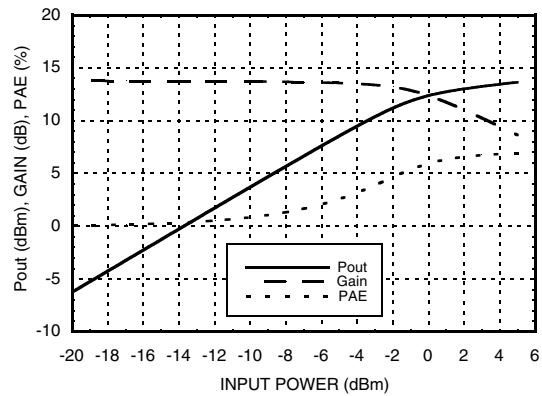

Output IP3 vs. Temperature

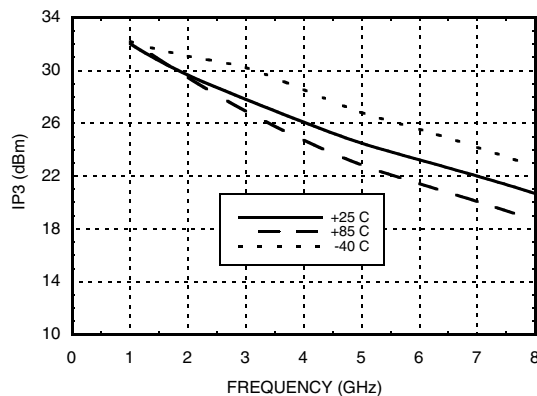

Gain, Power, Output IP3 & Supply Current vs. Supply Voltage @ 1 GHz

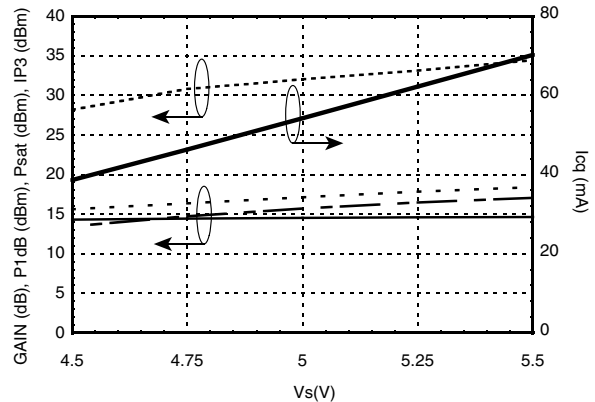

Information furnished by Analog Devices is believed to be accurate and reliable. However, no responsibility is assumed by Analog Devices for its use, nor for any infringements of patents or other rights of third parties that may result from its use. Specifications subject to change without notice. No license is granted by implication or otherwise under any patent or patent rights of Analog Devices. Trademarks and registered trademarks are the property of their respective owners.

For price, delivery, and to place orders: Analog Devices, Inc., One Technology Way, P.O. Box 9106, Norwood, MA 02062-9106 Phone: 781-329-4700 • Order online at www.analog.com Application Support: Phone: 1-800-ANALOG-D



InGaP HBT GAIN BLOCK MMIC AMPLIFIER, DC - 6 GHz

Absolute Maximum Ratings

Collector Bias Voltage (Vcc)	+7V
RF Input Power (RFIN)(Vs = +5V)	+10 dBm
Junction Temperature	150 °C
Continuous P _{diss} (T = 85 °C) (derate 5.21 mW/°C above 85 °C)	0.339 W
Thermal Resistance (junction to ground paddle)	192 °C/W
Storage Temperature	-65 to +150 °C
Operating Temperature	-40 to +85 °C
ESD Sensitivity (HBM)	Class 1A



ELECTROSTATIC SENSITIVE DEVICE
OBSERVE HANDLING PRECAUTIONS

Outline Drawing

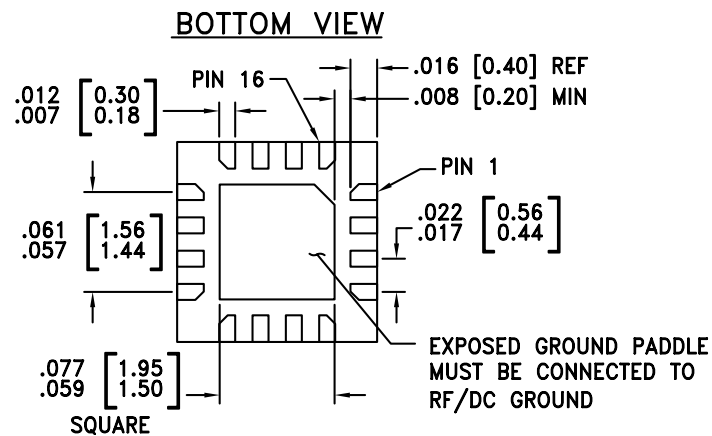
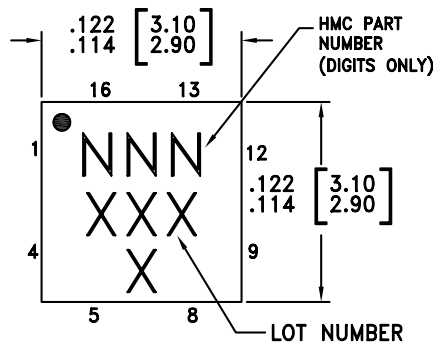

NOTES:

- LEADFRAME MATERIAL: COPPER ALLOY
- DIMENSIONS ARE IN INCHES [MILLIMETERS]
- LEAD SPACING TOLERANCE IS NON-CUMULATIVE
- PAD BURR LENGTH SHALL BE 0.15mm MAXIMUM.
PAD BURR HEIGHT SHALL BE 0.05mm MAXIMUM.
- PACKAGE WARP SHALL NOT EXCEED 0.05mm.
- ALL GROUND LEADS AND GROUND PADDLE MUST BE SOLDERED TO PCB RF GROUND.
- REFER TO HITTITE APPLICATION NOTE FOR SUGGESTED LAND PATTERN.

Package Information

Part Number	Package Body Material	Lead Finish	MSL Rating	Package Marking ^[3]
HMC311LP3	Low Stress Injection Molded Plastic	Sn/Pb Solder	MSL1 ^[1]	311 XXXX
HMC311LP3E	RoHS-compliant Low Stress Injection Molded Plastic	100% matte Sn	MSL1 ^[2]	311 XXXX

[1] Max peak reflow temperature of 235 °C

[2] Max peak reflow temperature of 260 °C

[3] 4-Digit lot number XXXX



InGaP HBT GAIN BLOCK MMIC AMPLIFIER, DC - 6 GHz

Pin Descriptions

Pin Number	Function	Description	Interface Schematic
1, 2, 4 - 9, 11 - 16	N/C	This pin may be connected to RF ground.	
3	RFIN	This pin is DC coupled. An off chip DC blocking capacitor is required.	
10	RFOUT	RF output and DC Bias for the output stage.	
	GND	Package bottom must be connected to RF/DC ground.	

Application Circuit

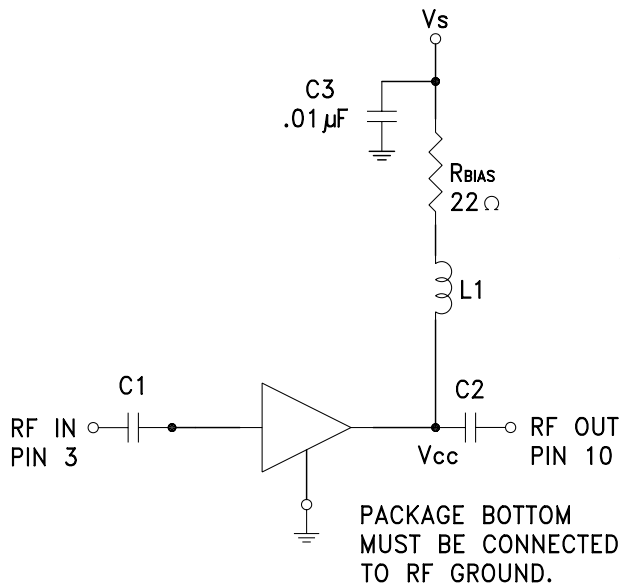

Note:

1. Select Rbias to achieve Icq using equation below, Rbias ≥ 22 Ohm.
2. External blocking capacitors are required on RFIN and RFOUT.

$$I_{cq} = \frac{V_s - 3.8}{R_{bias}}$$

Recommended Component Values

Component	Frequency (MHz)							
	50	900	1900	2200	2400	3500	5200	5800
L1	270 nH	56 nH	18 nH	18 nH	15 nH	8.2 nH	3.3 nH	3.3 nH
C1, C2	0.01 μF	100 pF	100 pF	100 pF	100 pF	100 pF	100 pF	100 pF



**InGaP HBT GAIN BLOCK
MMIC AMPLIFIER, DC - 6 GHz**

Evaluation PCB

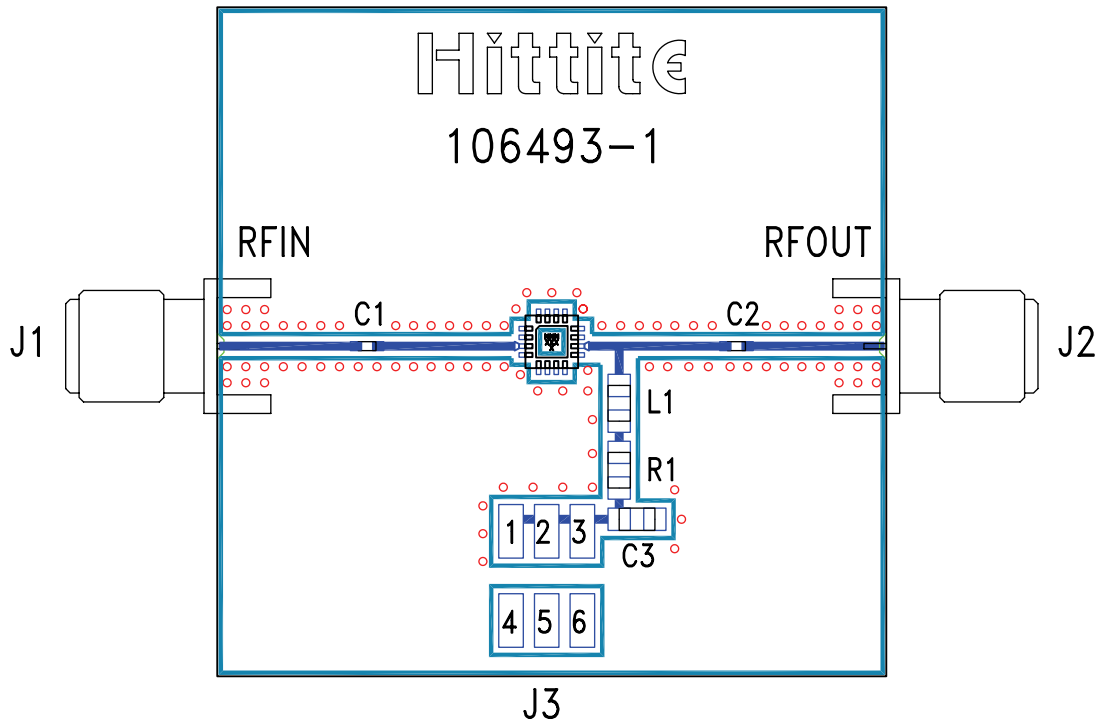

J3

Pin Number	Description
1, 2, 3	Vs
4, 5, 6	GND

List of Materials for Evaluation PCB 106789 [1]

Item	Description
J1 - J2	PC Mount SMA Connector
J3	2 mm DC Header
C1, C2	Capacitor, 0402 Pkg.
C3	10,000 pF Capacitor, 0805 Pkg.
R1	22 Ohm Resistor, 0805 Pkg.
L1	Inductor, 0805 Pkg.
U1	HMC311LP3 / HMC311LP3E
PCB [2]	106493 Evaluation PCB

[1] Reference this number when ordering complete evaluation PCB

[2] Circuit Board Material: Rogers 4350

The circuit board used in the final application should use RF circuit design techniques. Signal lines should have 50 Ohm impedance while the package ground leads and exposed paddle should be connected directly to the ground plane similar to that shown. A sufficient number of via holes should be used to connect the top and bottom ground planes. The evaluation board should be mounted to an appropriate heat sink. The evaluation circuit board shown is available from Hittite upon request.