



Chipsmall Limited consists of a professional team with an average of over 10 year of expertise in the distribution of electronic components. Based in Hongkong, we have already established firm and mutual-benefit business relationships with customers from,Europe,America and south Asia,supplying obsolete and hard-to-find components to meet their specific needs.

With the principle of “Quality Parts,Customers Priority,Honest Operation,and Considerate Service”,our business mainly focus on the distribution of electronic components. Line cards we deal with include Microchip,ALPS,ROHM,Xilinx,Pulse,ON,Everlight and Freescale. Main products comprise IC,Modules,Potentiometer,IC Socket,Relay,Connector.Our parts cover such applications as commercial,industrial, and automotives areas.

We are looking forward to setting up business relationship with you and hope to provide you with the best service and solution. Let us make a better world for our industry!



## Contact us

Tel: +86-755-8981 8866 Fax: +86-755-8427 6832

Email & Skype: info@chipsmall.com Web: www.chipsmall.com

Address: A1208, Overseas Decoration Building, #122 Zhenhua RD., Futian, Shenzhen, China





## GaAs PHEMT MMIC LOW NOISE AMPLIFIER, 350 - 550 MHz

### Typical Applications

The HMC356LP3 / HMC356LP3E is ideal for basestation receivers:

- GSM 450 & GSM 480
- CDMA 450
- Private Land Mobile Radio

### Features

- Noise Figure:  $\leq 1.0$  dB
- +38 dBm Output IP3
- Gain: 17 dB
- Very Stable Gain vs. Supply & Temperature
- Single Supply: +5V @ 104 mA
- 50 Ohm Matched Output

### Functional Diagram

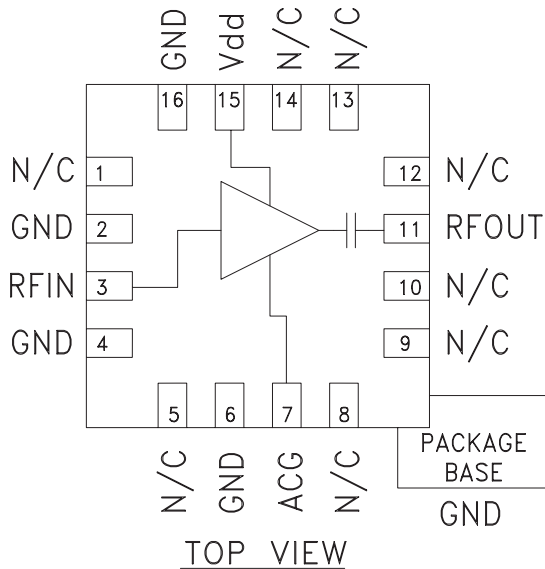

### General Description

The HMC356LP3 & HMC356LP3E are high dynamic range GaAs PHEMT MMIC Low Noise Amplifiers is ideal for GSM & CDMA cellular basestation and Mobile Radio front-end receivers operating between 350 and 550 MHz. This LNA has been optimized to provide 1.0 dB noise figure, 17 dB gain and +38 dBm output IP3 from a single supply of +5V @ 104 mA. Input and output return losses are 15 dB typical, with the LNA requiring only four external components to optimize the RF input match, RF ground and DC bias. For applications which require improved noise figure, please see the HMC616LP3(E).

### Electrical Specifications, $T_A = +25^\circ\text{C}$ , $V_s = +5\text{V}$

Parameter	Min.	Typ.	Max.	Units
Frequency Range	350 - 550			MHz
Gain	15	17		dB
Gain Variation Over Temperature		0.0032	0.010	dB / °C
Noise Figure		1.0	1.4	dB
Input Return Loss		17		dB
Output Return Loss		12		dB
Reverse Isolation		24		dB
Output Power for 1dB Compression (P1dB)	17	21		dBm
Saturated Output Power (Psat)		22.5		dBm
Output Third Order Intercept (IP3) (-20 dBm Input Power per tone, 1 MHz tone spacing)	34	38		dBm
Supply Current (Idd)		104		mA

Information furnished by Analog Devices is believed to be accurate and reliable. However, no responsibility is assumed by Analog Devices for its use, nor for any infringements of patents or other rights of third parties that may result from its use. Specifications subject to change without notice. No license is granted by implication or otherwise under any patent or patent rights of Analog Devices. Trademarks and registered trademarks are the property of their respective owners.

For price, delivery, and to place orders: Analog Devices, Inc., One Technology Way, P.O. Box 9106, Norwood, MA 02062-9106  
 Phone: 781-329-4700 • Order online at [www.analog.com](http://www.analog.com)  
 Application Support: Phone: 1-800-ANALOG-D

# HMC356\* PRODUCT PAGE QUICK LINKS

Last Content Update: 02/23/2017

---

## COMPARABLE PARTS

View a parametric search of comparable parts.

## EVALUATION KITS

- HMC356LP3 Evaluation Board

## DOCUMENTATION

### Application Notes

- AN-1363: Meeting Biasing Requirements of Externally Biased RF/Microwave Amplifiers with Active Bias Controllers
- Broadband Biasing of Amplifiers General Application Note
- MMIC Amplifier Biasing Procedure Application Note
- Thermal Management for Surface Mount Components General Application Note

### Data Sheet

- HMC356 Data Sheet

## TOOLS AND SIMULATIONS

- HMC356 S-Parameter

## REFERENCE MATERIALS

### Quality Documentation

- Package/Assembly Qualification Test Report: 16L 3x3mm QFN Package (QTR: 11003 REV: 02)
- Package/Assembly Qualification Test Report: LP2, LP2C, LP3, LP3B, LP3C, LP3D, LP3F, LP3G (QTR: 2014-0364)
- Package/Assembly Qualification Test Report: Plastic Encapsulated QFN (QTR: 05006 REV: 02)
- Semiconductor Qualification Test Report: PHEMT-B (QTR: 2013-00233)

### Technical Articles

- Active Multipliers & Dividers to Simplify Synthesizers

## DESIGN RESOURCES

- HMC356 Material Declaration
- PCN-PDN Information
- Quality And Reliability
- Symbols and Footprints

## DISCUSSIONS

View all HMC356 EngineerZone Discussions.

## SAMPLE AND BUY

Visit the product page to see pricing options.

## TECHNICAL SUPPORT

Submit a technical question or find your regional support number.

## DOCUMENT FEEDBACK

Submit feedback for this data sheet.

---





**GaAs PHEMT MMIC LOW NOISE  
AMPLIFIER, 350 - 550 MHz**

**Broadband Gain & Return Loss**

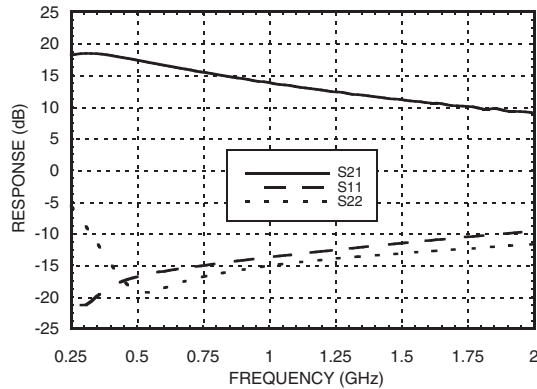

**Noise Figure vs. Temperature**

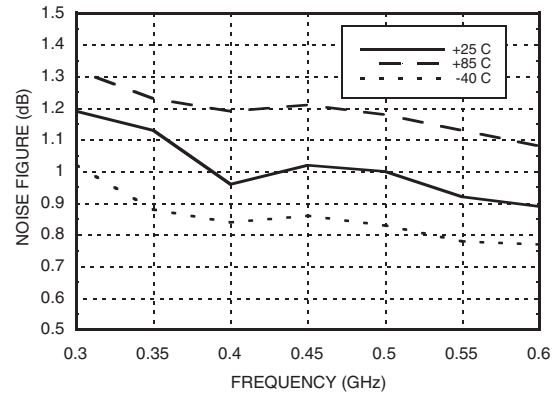

**Gain vs. Temperature**

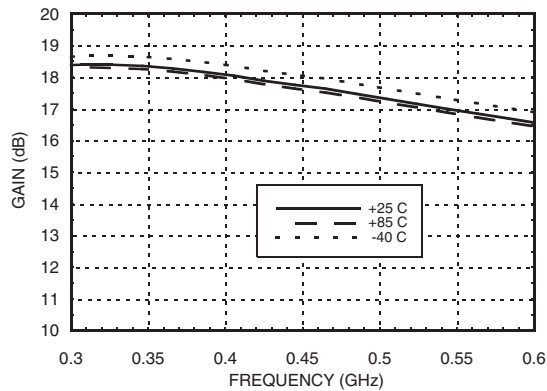

**Noise Figure vs. Vdd**

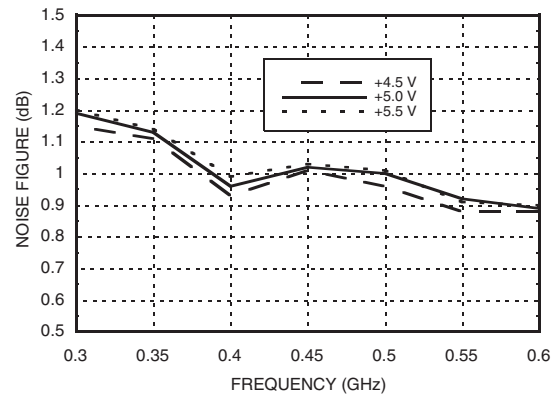

**Gain vs. Vdd**

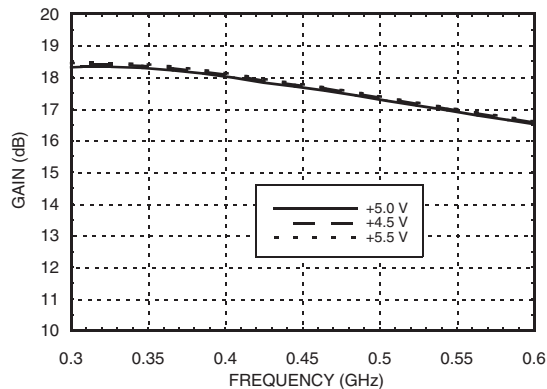

**Reverse Isolation**

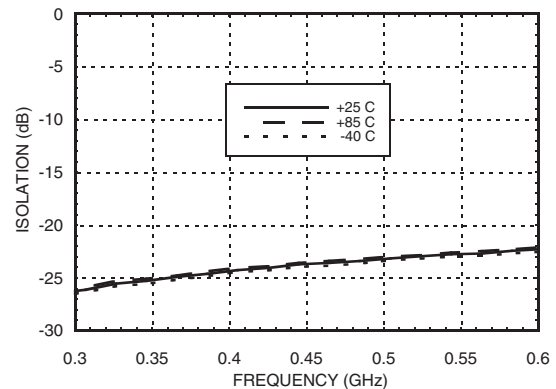

Information furnished by Analog Devices is believed to be accurate and reliable. However, no responsibility is assumed by Analog Devices for its use, nor for any infringements of patents or other rights of third parties that may result from its use. Specifications subject to change without notice. No license is granted by implication or otherwise under any patent or patent rights of Analog Devices. Trademarks and registered trademarks are the property of their respective owners.

For price, delivery, and to place orders: Analog Devices, Inc., One Technology Way, P.O. Box 9106, Norwood, MA 02062-9106 Phone: 781-329-4700 • Order online at [www.analog.com](http://www.analog.com) Application Support: Phone: 1-800-ANALOG-D

**GaAs PHEMT MMIC LOW NOISE AMPLIFIER, 350 - 550 MHz**



7

AMPLIFIERS - LOW NOISE - SMT

**Input Return Loss vs. Temperature**

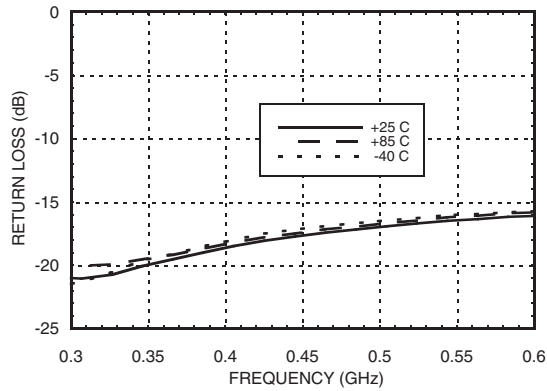

**Output Return Loss vs. Temperature**

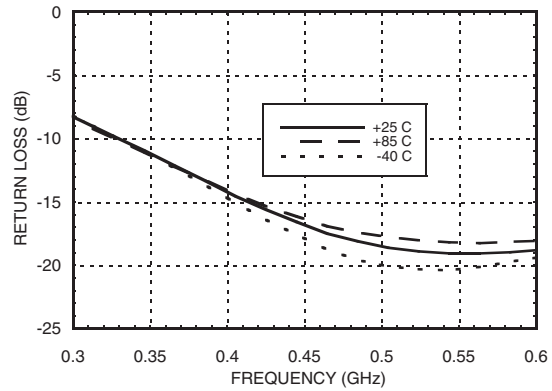

**Output IP3 vs. Temperature**

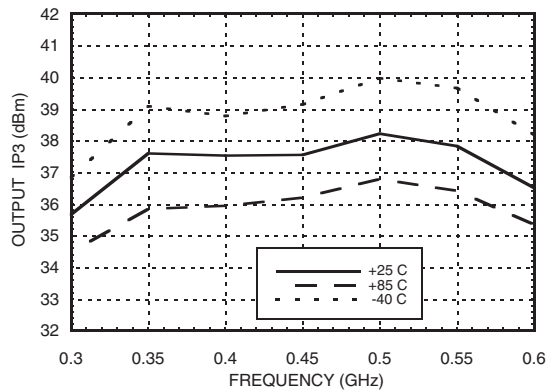

**P1dB & Psat vs. Temperature**

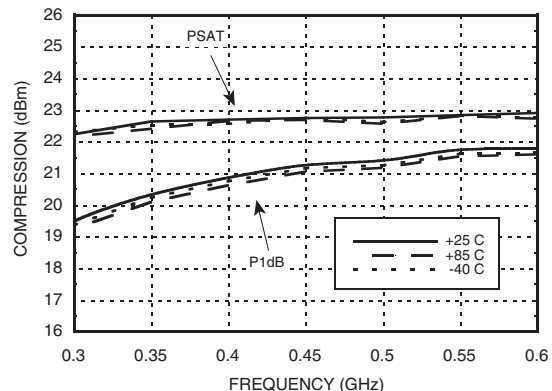

**Output IP3 vs. Vdd**

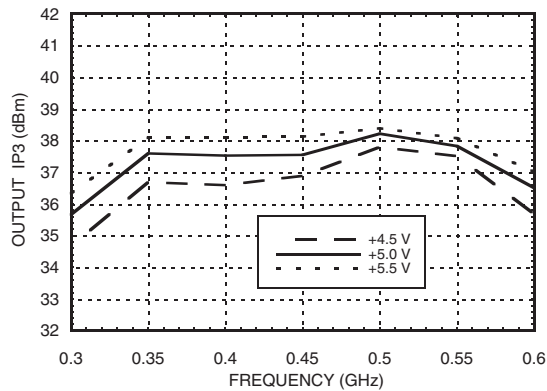

**P1dB vs. Vdd**

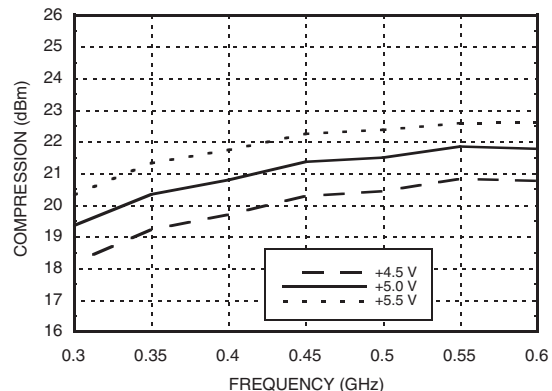

Information furnished by Analog Devices is believed to be accurate and reliable. However, no responsibility is assumed by Analog Devices for its use, nor for any infringements of patents or other rights of third parties that may result from its use. Specifications subject to change without notice. No license is granted by implication or otherwise under any patent or patent rights of Analog Devices. Trademarks and registered trademarks are the property of their respective owners.

For price, delivery, and to place orders: Analog Devices, Inc., One Technology Way, P.O. Box 9106, Norwood, MA 02062-9106 Phone: 781-329-4700 • Order online at [www.analog.com](http://www.analog.com) Application Support: Phone: 1-800-ANALOG-D

## GaAs PHEMT MMIC LOW NOISE AMPLIFIER, 350 - 550 MHz



### Absolute Maximum Ratings

Drain Bias Voltage (Vdd)	+8.0 Vdc
RF Input Power (RFIN)(Vdd = +5.0 Vdc)	+15 dBm
Channel Temperature	150 °C
Continuous P <sub>diss</sub> (T = 85 °C) (derate 14 mW/°C above 85 °C)	0.910 W
Thermal Resistance (channel to ground paddle)	71.4 °C/W
Storage Temperature	-65 to +150 °C
Operating Temperature	-40 to +85 °C

### Typical Supply Current vs. Vdd

Vdd (Vdc)	I <sub>dd</sub> (mA)
+4.5	103
+5.0	104
+5.5	105



ELECTROSTATIC SENSITIVE DEVICE  
OBSERVE HANDLING PRECAUTIONS

### Outline Drawing

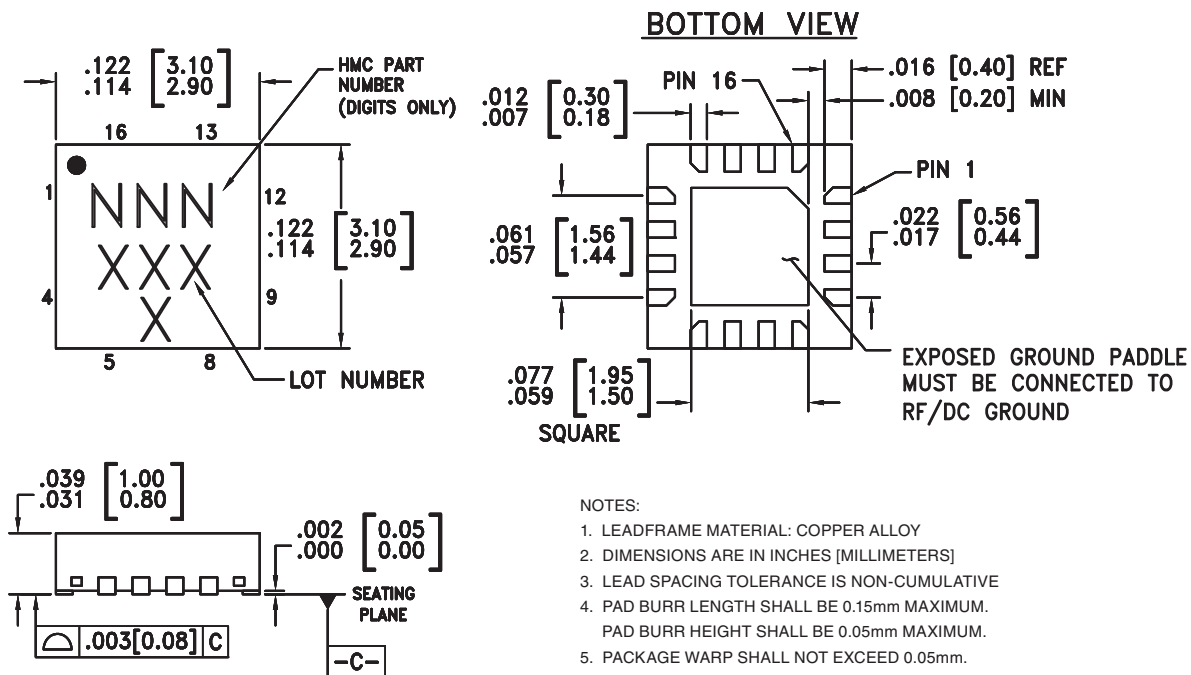

NOTES:

- LEADFRAME MATERIAL: COPPER ALLOY
- DIMENSIONS ARE IN INCHES [MILLIMETERS]
- LEAD SPACING TOLERANCE IS NON-CUMULATIVE
- PAD BURR LENGTH SHALL BE 0.15mm MAXIMUM.  
PAD BURR HEIGHT SHALL BE 0.05mm MAXIMUM.
- PACKAGE WARP SHALL NOT EXCEED 0.05mm.
- ALL GROUND LEADS AND GROUND PADDLE MUST BE SOLDERED TO PCB RF GROUND.
- REFER TO HITTITE APPLICATION NOTE FOR SUGGESTED LAND PATTERN.

### Package Information

Part Number	Package Body Material	Lead Finish	MSL Rating	Package Marking <sup>[3]</sup>
HMC356LP3	Low Stress Injection Molded Plastic	Sn/Pb Solder	MSL1 <sup>[1]</sup>	356 XXXX
HMC356LP3E	RoHS-compliant Low Stress Injection Molded Plastic	100% matte Sn	MSL1 <sup>[2]</sup>	356 XXXX

[1] Max peak reflow temperature of 235 °C

[2] Max peak reflow temperature of 260 °C

[3] 4-Digit lot number XXXX



### Pin Descriptions

Pin Number	Function	Description	Interface Schematic
1, 5, 8, 9, 10, 12, 13, 14	N/C	No connection necessary. These pins may be connected to RF/DC ground.	
2, 4, 6, 16	GND	These pins and package ground paddle must be connected to RF/DC ground.	
3	RFIN	This pin is matched to 50 Ohms with a 51 nH inductor to ground. See Application Circuit.	
7	ACG	AC Ground - An external capacitor of 0.01µF to ground is required for low frequency bypassing. See Application Circuit for further details.	
11	RFOUT	This pin is AC coupled and matched to 50 Ohms.	
15	Vdd	Power supply voltage. Choke inductor and bypass capacitor are required. See application circuit.	

### Application & Evaluation PCB Circuit

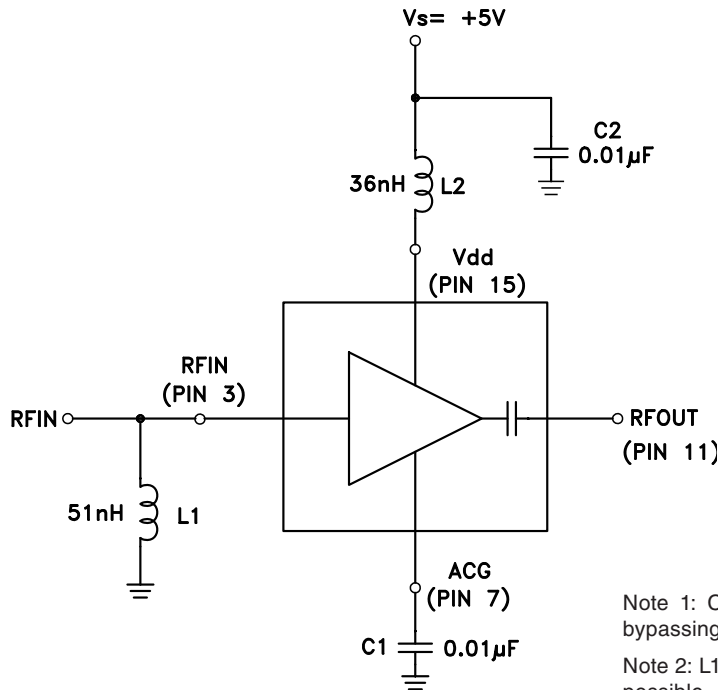

Note 1: Choose value of capacitor C1 for low frequency bypassing. A 0.01 µF ±10% capacitor is recommended.

Note 2: L1, L2 and C1 should be located as close to pins as possible.

Information furnished by Analog Devices is believed to be accurate and reliable. However, no responsibility is assumed by Analog Devices for its use, nor for any infringements of patents or other rights of third parties that may result from its use. Specifications subject to change without notice. No license is granted by implication or otherwise under any patent or patent rights of Analog Devices. Trademarks and registered trademarks are the property of their respective owners.

For price, delivery, and to place orders: Analog Devices, Inc., One Technology Way, P.O. Box 9106, Norwood, MA 02062-9106 Phone: 781-329-4700 • Order online at [www.analog.com](http://www.analog.com) Application Support: Phone: 1-800-ANALOG-D



### Evaluation PCB

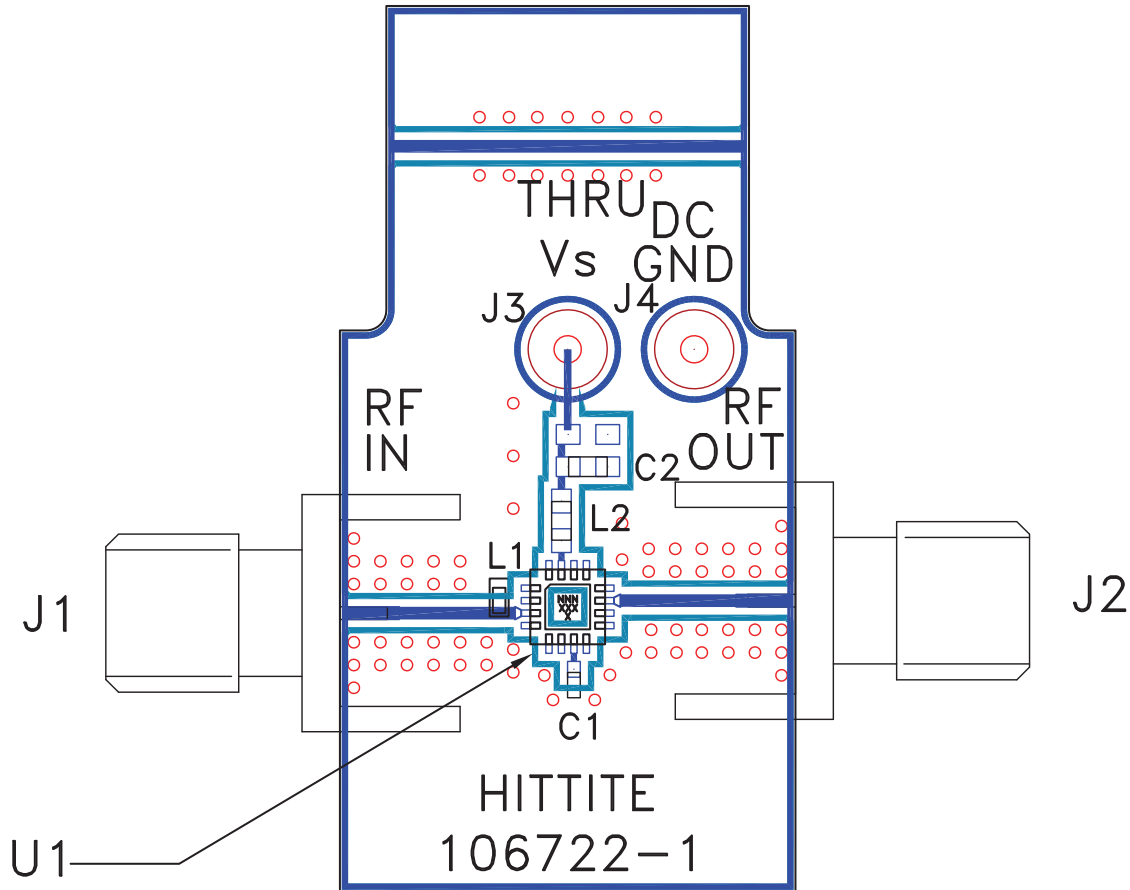

### List of Materials for Evaluation PCB 107795 [1]

Item	Description
J1 - J2	PCB Mount SMA RF Connector
J3 - J4	DC Pin
C1	10,000 pF Capacitor, 0402 Pkg.
C2	10,000 pF Capacitor, 0603 Pkg.
L1	51 nH Inductor, 0402 Pkg.
L2	36 nH Inductor, 0603 Pkg.
U1	HMC356LP3 / HMC356LP3E Amplifier
PCB [2]	106722 Evaluation PCB

The circuit board used in the application should use RF circuit design techniques. Signal lines should have 50 Ohm impedance while the package ground leads and exposed paddle should be connected directly to the ground plane similar to that shown. A sufficient number of via holes should be used to connect the top and bottom ground planes. The evaluation circuit board shown is available from Hittite upon request.

[1] Reference this number when ordering complete evaluation PCB

[2] Circuit Board Material: Rogers 4350