



Chipsmall Limited consists of a professional team with an average of over 10 year of expertise in the distribution of electronic components. Based in Hongkong, we have already established firm and mutual-benefit business relationships with customers from,Europe,America and south Asia,supplying obsolete and hard-to-find components to meet their specific needs.

With the principle of “Quality Parts,Customers Priority,Honest Operation,and Considerate Service”,our business mainly focus on the distribution of electronic components. Line cards we deal with include Microchip,ALPS,ROHM,Xilinx,Pulse,ON,Everlight and Freescale. Main products comprise IC,Modules,Potentiometer,IC Socket,Relay,Connector.Our parts cover such applications as commercial,industrial, and automotives areas.

We are looking forward to setting up business relationship with you and hope to provide you with the best service and solution. Let us make a better world for our industry!



Contact us

Tel: +86-755-8981 8866 Fax: +86-755-8427 6832

Email & Skype: info@chipsmall.com Web: www.chipsmall.com

Address: A1208, Overseas Decoration Building, #122 Zhenhua RD., Futian, Shenzhen, China





CELLULAR RFIC DOWNCONVERTER, 0.7 - 1.0 GHz

Typical Applications

The HMC420QS16 / HMC420QS16E is ideal for:

- GSM & CDMA Infrastructure
- GPRS & EDGE Infrastructure
- Wireless Data/CDPD

Features

- +15 dBm Input IP3
- Integrated IF & LO Amps: 0 dBm LO
- Conversion Gain: 12.5 dB
- Noise Figure: 13 dB
- Single Positive Supply: +5V, 52 mA

Functional Diagram

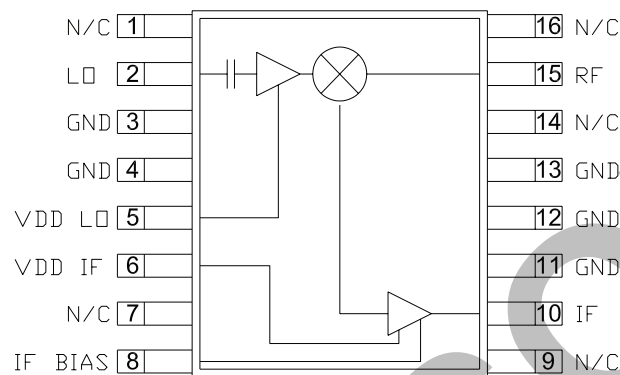

General Description

The HMC420QS16 & HMC420QS16E are linear downconverter receiver ICs suitable for cellular infrastructure applications from 0.7 - 1.0 GHz. An integrated mixer coupled with a high dynamic range IF amplifier achieves an input intercept point (OIP3) of +15 dBm, and an input P1dB of +1 dBm. The converter provides a gain of 12.5 dB and 13 dB typical single side band noise. The IC operates from positive +5V rails consuming 52 mA of current while requiring only 0 dBm LO drive. The design requires no external baluns, and minimal off chip components. The HMC420QS16 & HMC420QS16E have the same package footprint as the HMC380QS16G & HMC421QS16 1.4 - 2.3 GHz downconverter ICs.

Electrical Specifications, $T_A = +25^\circ\text{C}$, LO = 0 dBm, IF = 120 MHz, Vdd = 5V

Parameter	Min.	Typ.	Max.	
Frequency Range, RF & LO	0.7 - 1.0			GHz
Frequency Range, IF *	50 - 250			MHz
Conversion Gain	9	12.5		dB
Noise Figure (SSB)		13		dB
LO to RF Isolation	15	25		dB
LO to IF Isolation	23	30 - 42		dB
RF to IF Isolation	33	40 - 55		dB
IP3 (Input)	12	15		dBm
1 dB Compression (Input)	-2	+1		dBm
LO Input Drive Level (Typical)	-2 to +4			dBm
Supply Current (Idd for IF + LO) (IF bias resistor= 6.8 ohms)		52		mA

* IF matching must be tuned for optimal results. See application circuit herein.



**Conversion Gain
vs. Temperature @ LO = 0 dBm**

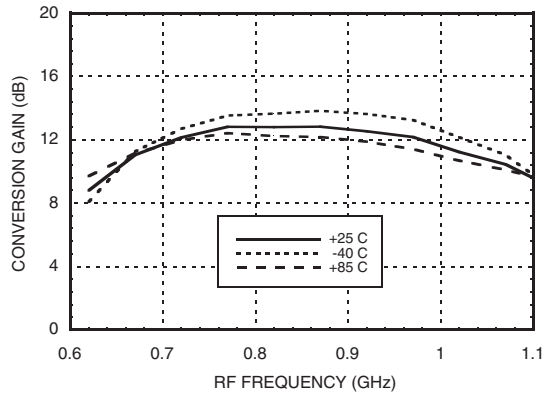

Isolation @ LO = 0 dBm

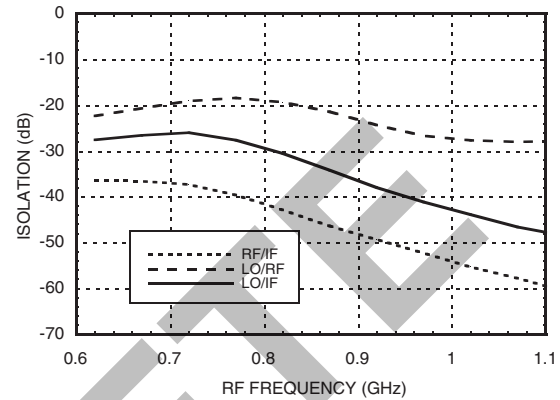

Conversion Gain vs. LO Drive

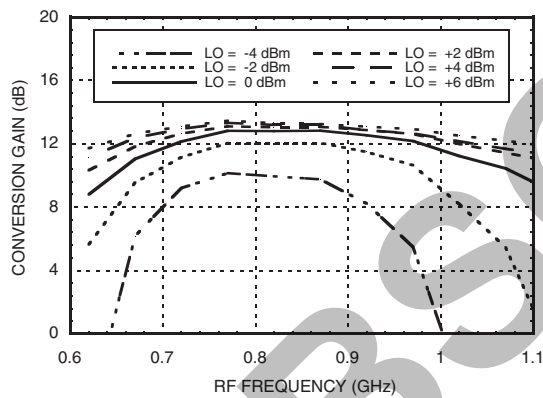

Return Loss @ LO = 0 dBm

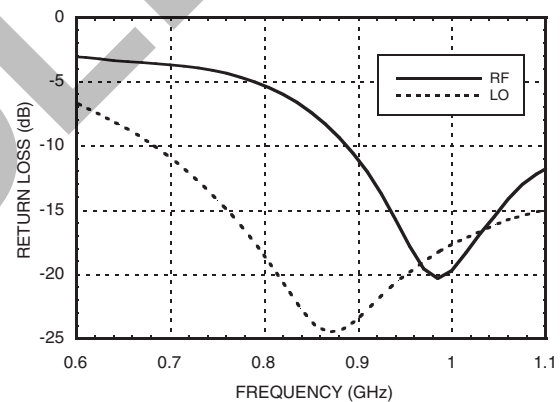

Conversion Gain vs. Vdd @ LO = 0 dBm

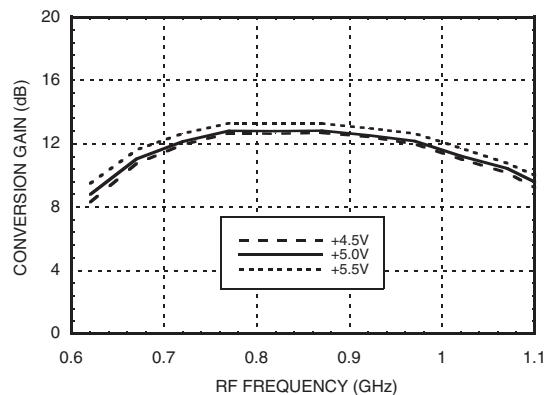

Information furnished by Analog Devices is believed to be accurate and reliable. However, no responsibility is assumed by Analog Devices for its use, nor for any infringements of patents or other rights of third parties that may result from its use. Specifications subject to change without notice. No license is granted by implication or otherwise under any patent or patent rights of Analog Devices. Trademarks and registered trademarks are the property of their respective owners.

For price, delivery, and to place orders: Analog Devices, Inc., One Technology Way, P.O. Box 9106, Norwood, MA 02062-9106 Phone: 781-329-4700 • Order online at www.analog.com Application Support: Phone: 1-800-ANALOG-D



**CELLULAR RFIC
DOWNCONVERTER, 0.7 - 1.0 GHz**

**Input P1dB vs.
Temperature @ LO = 0 dBm**

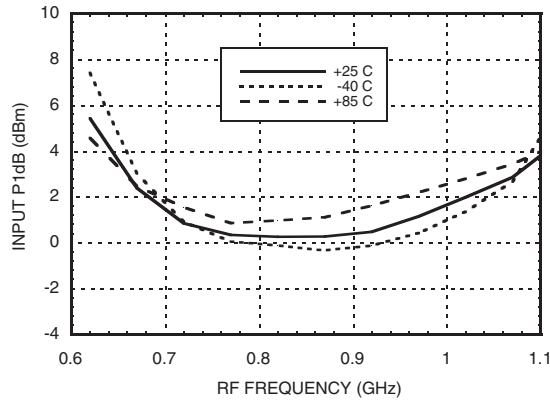

Input P1dB vs. Vdd @ LO = 0 dBm

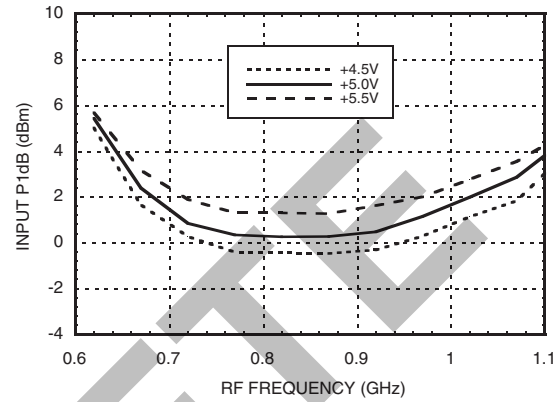

**Input and Output
IP3 vs. Temperature @ LO = 0 dBm***

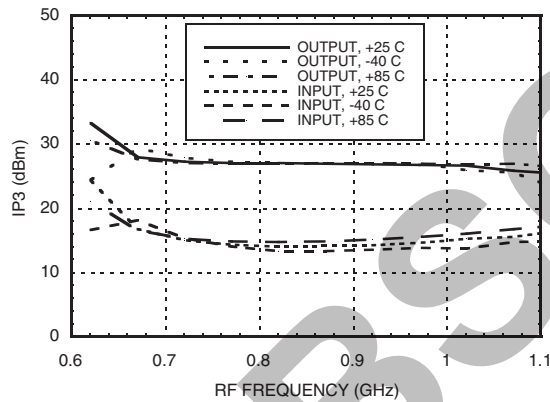

Input and Output IP3 vs. LO Drive*

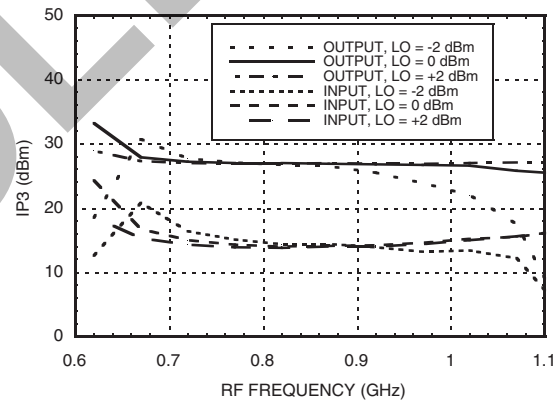

**Input and Output
IP3 vs. Vdd @ LO = 0 dBm***

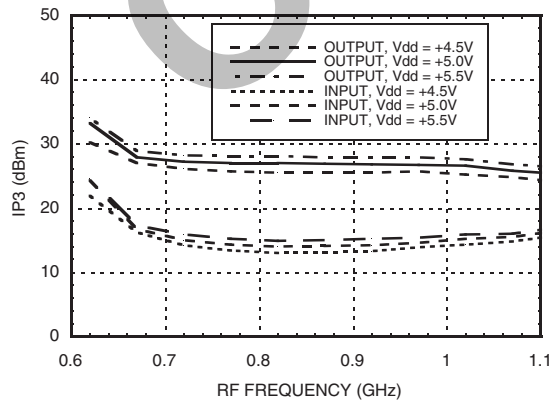

Input IP2 vs. Temperature @ LO = 0 dBm*

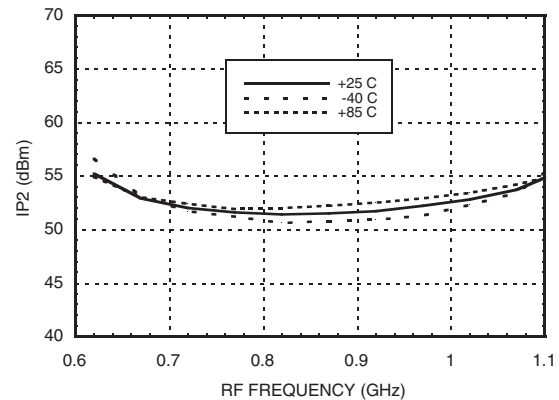

*Two-tone input power= -5 dBm each tone, 1 MHz spacing.



**CELLULAR RFIC
DOWNCONVERTER, 0.7 - 1.0 GHz**

**Noise Figure vs. Temperature,
Swept LO, Fixed IF= 120 MHz**

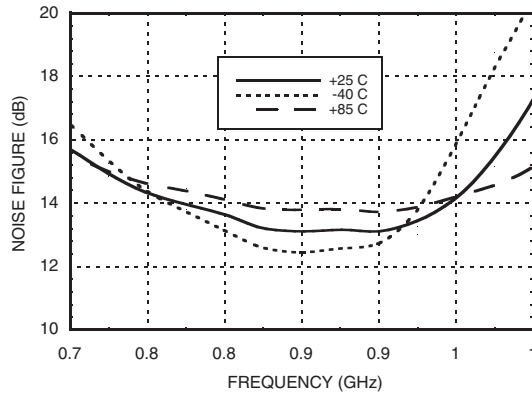

**Noise Figure
Swept IF, Fixed LO = 800 MHz**

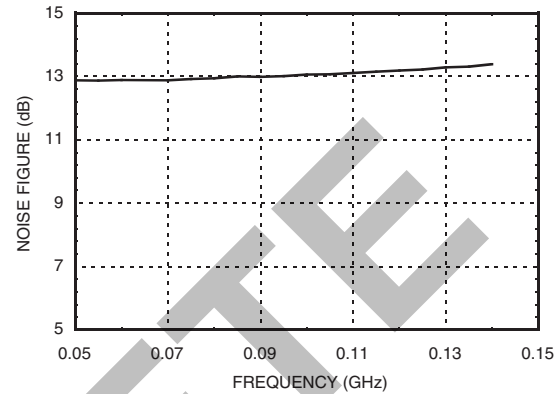

**IF Return Loss
@ Various Tuned IF Frequencies***

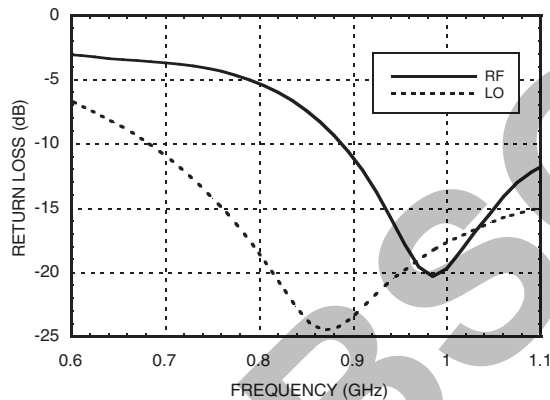

**IF Bandwidth
@ Various Tuned IF Frequencies***

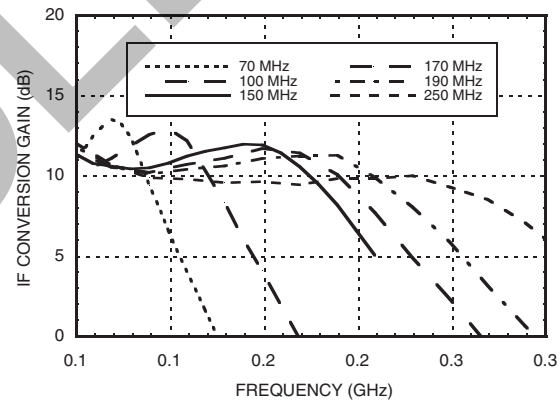

**IF Bandwidth
@ LO = 0 dBm, IF= 120 MHz***

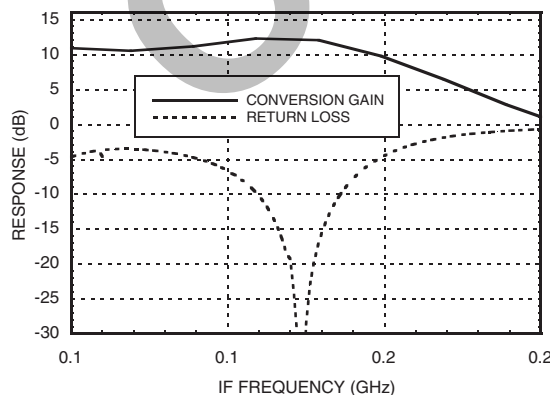

Harmonics of LO

LO Freq. (GHz)	nLO Spur @ RF Port			
	1	2	3	4
0.55	21	14	50	45
0.65	18	12	48	43
0.75	22	15	42	38
0.85	27	20	40	46
0.95	28	26	44	57
1.05	27	31	54	66

LO = 0 dBm
Values in dBc below input LO level measured at RF port.

* Refer to HMC420QS16 Application Circuit herein for IF port tuning information.



MxN Spurious @ IF Port

mRF	nLO				
	0	1	2	3	4
0	xx	41	89	66	75
1	62	0	64	>113	103
2	>113	102	51	82	>113
3	>113	>113	>113	71	>113
4	>113	>113	>113	>113	>113

RF Freq.= 0.92 GHz @ -10 dBm
LO Freq.= 0.8 GHz @ 0 dBm
All values in dBc relative to the IF power level.



**ELECTROSTATIC SENSITIVE DEVICE
OBSERVE HANDLING PRECAUTIONS**

Absolute Maximum Ratings

RF / IF Input (Vdd= +5V)	+13 dBm
LO Drive (Vdd= +5V)	+15 dBm
Vdd (LO or IF)	+7 Vdc
Channel Temperature	150°C
Continuous P _{diss} (T = 85°C) (derate 6.34 mW/°C above 85°C)	0.41 W
Storage Temperature	-65 to +150 °C
Operating Temperature	-40 to +85 deg °C

Typical Supply Current vs. Vdd

Vdd (Vdc)	I _{dd} (mA)
4.5	51
5.0	52
5.5	53

Note: Mixer will operate over full voltage range shown above.

Outline Drawing

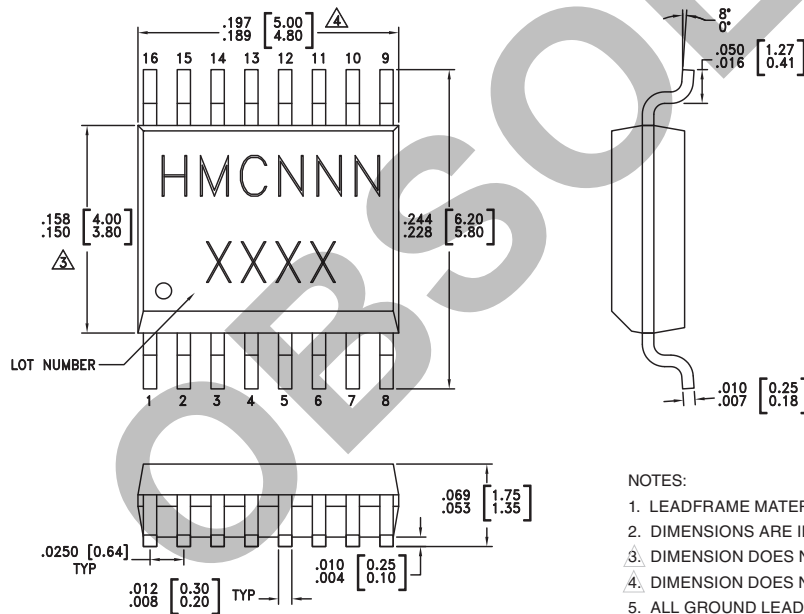

NOTES:

1. LEADFRAME MATERIAL: COPPER ALLOY
2. DIMENSIONS ARE IN INCHES [MILLIMETERS]
3. DIMENSION DOES NOT INCLUDE MOLDFLASH OF 0.15mm PER SIDE.
4. DIMENSION DOES NOT INCLUDE MOLDFLASH OF 0.25mm PER SIDE.
5. ALL GROUND LEADS MUST BE SOLDERED TO PCB RF GROUND.

Package Information

Part Number	Package Body Material	Lead Finish	MSL Rating	Package Marking ^[3]
HMC420QS16	Low Stress Injection Molded Plastic	Sn/Pb Solder	MSL1 ^[1]	HMC420 XXXX
HMC420QS16E	RoHS-compliant Low Stress Injection Molded Plastic	100% matte Sn	MSL1 ^[2]	HMC420 XXXX

[1] Max peak reflow temperature of 235 °C

[2] Max peak reflow temperature of 260 °C

[3] 4-Digit lot number XXXX

Information furnished by Analog Devices is believed to be accurate and reliable. However, no responsibility is assumed by Analog Devices for its use, nor for any infringements of patents or other rights of third parties that may result from its use. Specifications subject to change without notice. No license is granted by implication or otherwise under any patent or patent rights of Analog Devices. Trademarks and registered trademarks are the property of their respective owners.

For price, delivery, and to place orders: Analog Devices, Inc., One Technology Way, P.O. Box 9106, Norwood, MA 02062-9106 Phone: 781-329-4700 • Order online at www.analog.com Application Support: Phone: 1-800-ANALOG-D



Pin Descriptions

Pin Number	Function	Description	Interface Schematic
1, 7, 9, 14, 16	N/C	Not Connected	
2	LO	This pin is AC coupled and matched to 50 Ohm from 0.7 - 1.0 GHz. An external series inductor (6.8 nH) is required.	
3, 4, 11, 12, 13	GND	Pin must connect to RF ground.	
5	Vdd LO	Power supply for the LO amplifier. One external RF bypass capacitor (10,000 pF) is required.	
6	Vdd IF	Bias voltage for IF amplifier. One external RF bypass capacitor (10,000 pF) is required.	
8	IF Bias	DC bias setting for IF amplifier.	
10	IF	Output of IF and bias port for amplifier. A pull up inductor (L1), output matching network (C5, C6, L2), and 10,000 pF bypass capacitor (C4) are required.	
15	RF	This pin is DC coupled and matched to 50 Ohm from 0.7 - 1.0 GHz.	



**CELLULAR RFIC
DOWNCONVERTER, 0.7 - 1.0 GHz**

Evaluation PCB

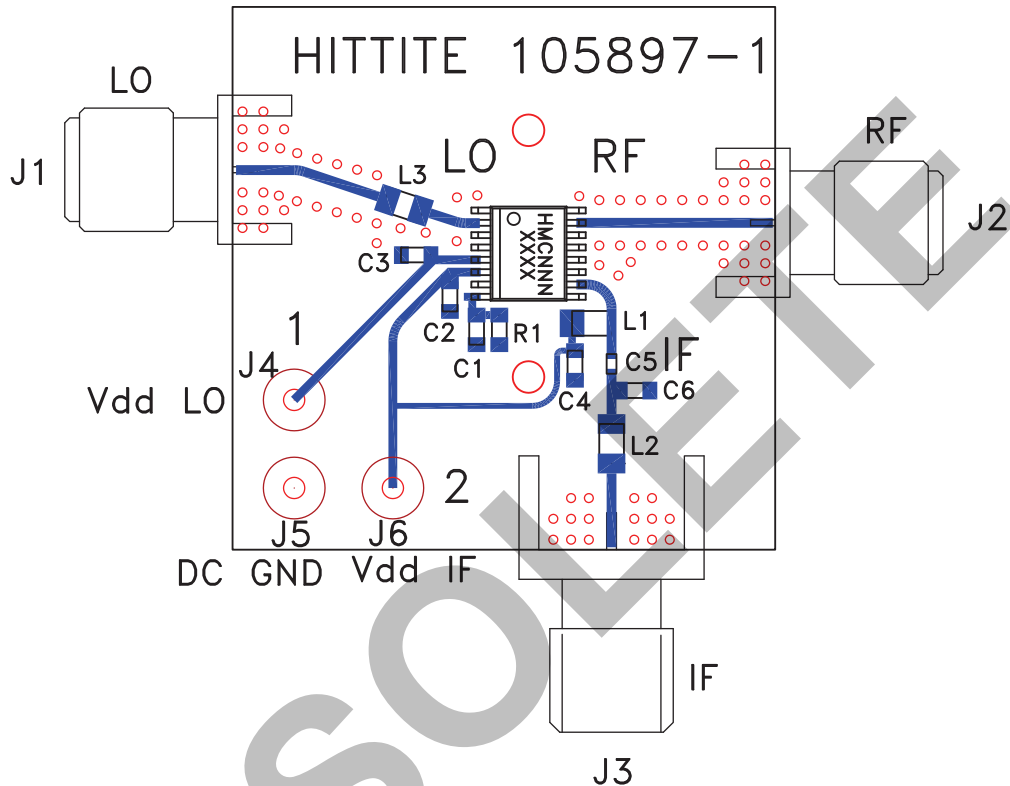

List of Materials for Evaluation PCB 105361 [1]

Item	Description
J1 - J3	PCB Mount SMA RF Connector
J4 - J6	DC Pins
C1	1000 pF Chip Capacitor, 0603 Pkg.
C2, C3, C4	0.01µF Chip Capacitor, 0603 Pkg.
C5	33 pF Chip Capacitor, 0402 Pkg.
C6 [3]	12 pF Chip Capacitor, 0603 Pkg.
L1	330 nH Chip Inductor, 0805 Pkg.
L2 [3]	150 nH Chip Inductor, 0805
L3	6.8 nH Inductor, 0805 Pkg.
R1	6.8 Ohm Resistor, 0603
U1	HMC420QS16 / HMC420QS16E Mixer
PCB [2]	105897 Evaluation Board, 1.100" x 1.100"

[1] Reference this number when ordering complete evaluation PCB

[2] Circuit Board Material: Rogers 4350

[3] For 120 MHz IF. See Application Circuit for alternate IF frequency tuning.

The circuit board used in the final application should use RF circuit design techniques. Signal lines should have 50 Ohm impedance while the package ground leads should be connected directly to the ground plane similar to that shown. A sufficient number of via holes should be used to connect the top and bottom ground planes. The evaluation circuit board shown is available from Hittite upon request.



**CELLULAR RFIC
DOWNCONVERTER, 0.7 - 1.0 GHz**

Application Circuit

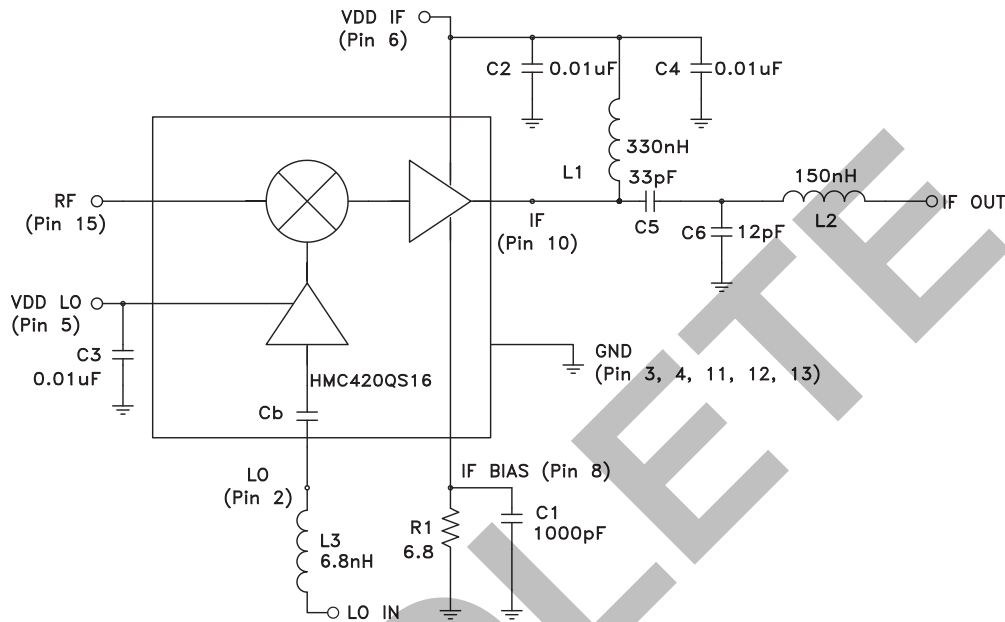

Note: Pin 5 and Pin 6 may be connected to a common Vdd Supply.

**Selection of L2 & C6
For Various Tuned IF Frequencies**

IF	L2*	C6*
120 MHz	150 nH	12 pF
70 MHz	180 nH	39 pF
100 MHz	180 nH	18 pF
150 MHz	120 nH	9 pF
170 MHz	120 nH	7 pF
190 MHz	100 nH	6 pF
250 MHz	82 nH	4 pF

Information furnished by Analog Devices is believed to be accurate and reliable. However, no responsibility is assumed by Analog Devices for its use, nor for any infringements of patents or other rights of third parties that may result from its use. Specifications subject to change without notice. No license is granted by implication or otherwise under any patent or patent rights of Analog Devices. Trademarks and registered trademarks are the property of their respective owners.

For price, delivery, and to place orders: Analog Devices, Inc., One Technology Way, P.O. Box 9106, Norwood, MA 02062-9106 Phone: 781-329-4700 • Order online at www.analog.com Application Support: Phone: 1-800-ANALOG-D