



Chipsmall Limited consists of a professional team with an average of over 10 year of expertise in the distribution of electronic components. Based in Hongkong, we have already established firm and mutual-benefit business relationships with customers from,Europe,America and south Asia,supplying obsolete and hard-to-find components to meet their specific needs.

With the principle of “Quality Parts,Customers Priority,Honest Operation,and Considerate Service”,our business mainly focus on the distribution of electronic components. Line cards we deal with include Microchip,ALPS,ROHM,Xilinx,Pulse,ON,Everlight and Freescale. Main products comprise IC,Modules,Potentiometer,IC Socket,Relay,Connector.Our parts cover such applications as commercial,industrial, and automotives areas.

We are looking forward to setting up business relationship with you and hope to provide you with the best service and solution. Let us make a better world for our industry!



Contact us

Tel: +86-755-8981 8866 Fax: +86-755-8427 6832

Email & Skype: info@chipsmall.com Web: www.chipsmall.com

Address: A1208, Overseas Decoration Building, #122 Zhenhua RD., Futian, Shenzhen, China





GaAs PHEMT MMIC MEDIUM POWER AMPLIFIER, 7 - 15.5 GHz

Typical Applications

The HMC441LH5 is a medium PA for:

- Telecom Infrastructure
- Military Radio, Radar & ECM
- Space Systems
- Test Instrumentation

Features

- Gain: 5 dB
- Saturated Power: +21.5 dBm @ 25% PAE
- Single Positive Supply: +5V
- 50 Ohms Matched Input/Output
- Hermetic SMT Package, 25mm²
- Screening to MIL-PRF-38535 (Class B or S) Available

Functional Diagram

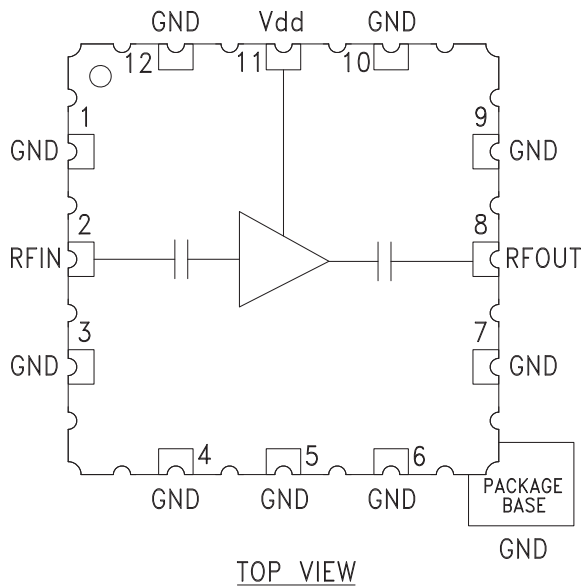

General Description

The HMC441LH5 is a broadband 7 to 15.5 GHz GaAs PHEMT MMIC Medium Power Amplifier housed in a hermetic SMT leadless package. The amplifier provides 15 dB of gain and 21.5 dBm of saturated power at 25% PAE from a +5V supply. This 50 Ohm matched amplifier does not require any external components, and the RF I/Os are DC blocked, making it an ideal linear gain block or driver amplifier. The HMC441LH5 allows the use of surface mount manufacturing techniques and is suitable for high reliability military, industrial & space applications.

Electrical Specifications, $T_A = +25^\circ\text{C}$, $V_{DD} = 5\text{V}$

Parameter	Min.	Typ.	Max.	Min.	Typ.	Max.	Min.	Typ.	Max.	Min.	Typ.	Max.	Units
Frequency Range	7.0 - 8.0			8.0 - 13.0			13.0 - 14.0			14.0 - 15.5			GHz
Gain	11	14		13	16		12	15		10.5	13.5		dB
Gain Variation Over Temperature		0.015	0.02		0.015	0.02		0.015	0.02		0.015	0.02	dB/°C
Input Return Loss		11			13			10			8		dB
Output Return Loss		10			15			14			12		dB
Output Power for 1 dB Compression (P1dB)	15.5	18.5		17	20		16	19		16	19		dBm
Saturated Output Power (Psat)		20			21			21.5			21		dBm
Output Third Order Intercept (IP3)		30			32			32			32		dBm
Noise Figure		5.0			4.75			4.75			5.0		dB
Supply Current (I _{DD})		90	115		90	115		90	115		90	115	mA

Information furnished by Analog Devices is believed to be accurate and reliable. However, no responsibility is assumed by Analog Devices for its use, nor for any infringements of patents or other rights of third parties that may result from its use. Specifications subject to change without notice. No license is granted by implication or otherwise under any patent or patent rights of Analog Devices. Trademarks and registered trademarks are the property of their respective owners.

For price, delivery, and to place orders: Analog Devices, Inc., One Technology Way, P.O. Box 9106, Norwood, MA 02062-9106 Phone: 781-329-4700 • Order online at www.analog.com Application Support: Phone: 1-800-ANALOG-D

HMC441LH5* PRODUCT PAGE QUICK LINKS

Last Content Update: 02/23/2017

COMPARABLE PARTS

View a parametric search of comparable parts.

EVALUATION KITS

- HMC441LH5 Evaluation Board

DOCUMENTATION

Application Notes

- AN-1363: Meeting Biasing Requirements of Externally Biased RF/Microwave Amplifiers with Active Bias Controllers
- Broadband Biasing of Amplifiers General Application Note
- MMIC Amplifier Biasing Procedure Application Note
- Thermal Management for Surface Mount Components General Application Note

Data Sheet

- HMC441LH5 Data Sheet

TOOLS AND SIMULATIONS

- HMC441LH5 S-Parameters

REFERENCE MATERIALS

Quality Documentation

- Semiconductor Qualification Test Report: PHEMT-F (QTR: 2013-00269)

DESIGN RESOURCES

- HMC441LH5 Material Declaration
- PCN-PDN Information
- Quality And Reliability
- Symbols and Footprints

DISCUSSIONS

View all HMC441LH5 EngineerZone Discussions.

SAMPLE AND BUY

Visit the product page to see pricing options.

TECHNICAL SUPPORT

Submit a technical question or find your regional support number.

DOCUMENT FEEDBACK

Submit feedback for this data sheet.



**GaAs PHEMT MMIC MEDIUM
POWER AMPLIFIER, 7 - 15.5 GHz**

Broadband Gain & Return Loss

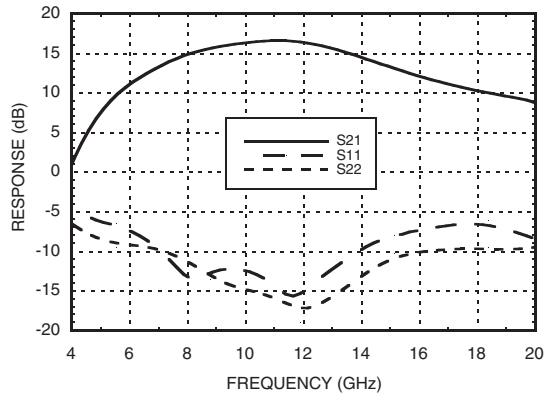

Gain vs. Temperature

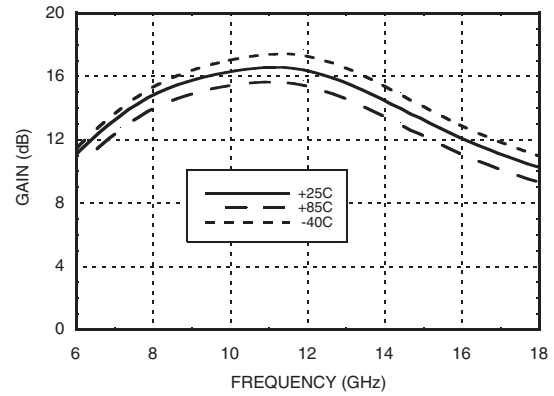

Input Return Loss vs. Temperature

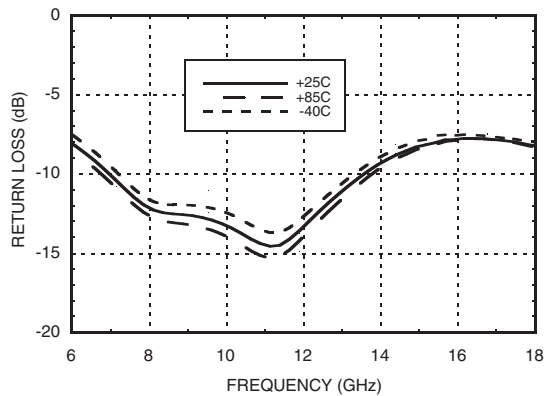

Output Return Loss vs. Temperature

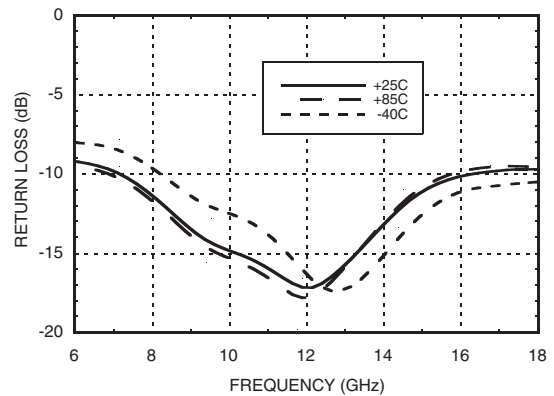

P1dB vs. Temperature

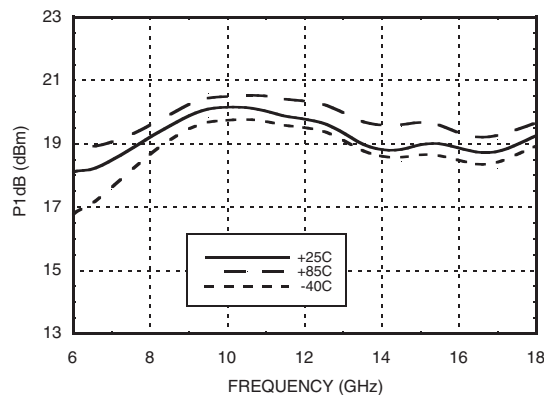

Psat vs. Temperature

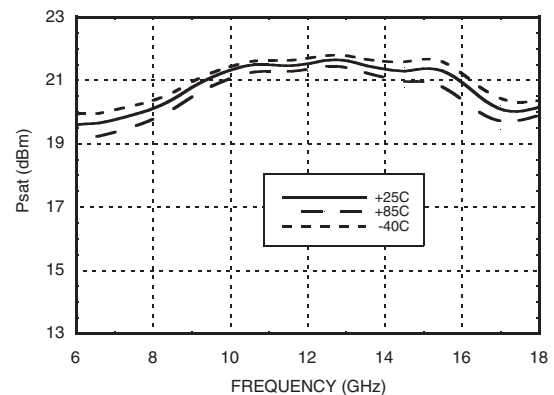

Information furnished by Analog Devices is believed to be accurate and reliable. However, no responsibility is assumed by Analog Devices for its use, nor for any infringements of patents or other rights of third parties that may result from its use. Specifications subject to change without notice. No license is granted by implication or otherwise under any patent or patent rights of Analog Devices. Trademarks and registered trademarks are the property of their respective owners.

For price, delivery, and to place orders: Analog Devices, Inc., One Technology Way, P.O. Box 9106, Norwood, MA 02062-9106 Phone: 781-329-4700 • Order online at www.analog.com Application Support: Phone: 1-800-ANALOG-D



**GaAs PHEMT MMIC MEDIUM
POWER AMPLIFIER, 7 - 15.5 GHz**

Power Compression @ 12 GHz

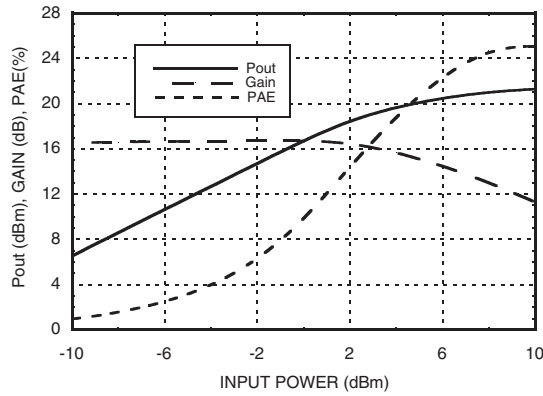

Output IP3 vs. Temperature

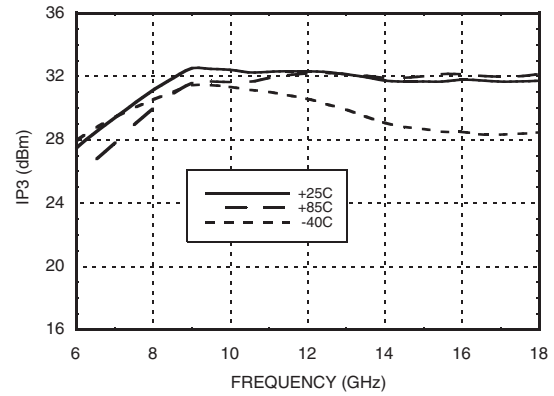

**Gain, Power & Output IP3
vs. Supply Voltage @ 12 GHz**

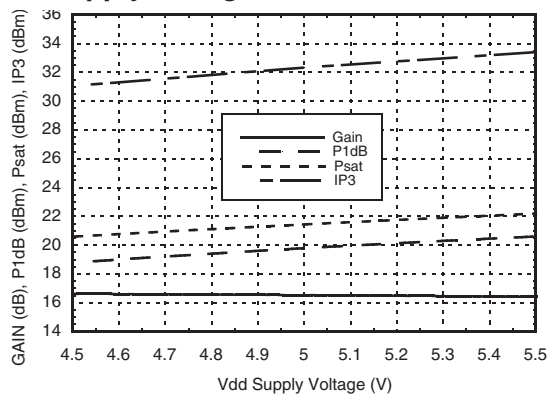

Noise Figure vs. Temperature

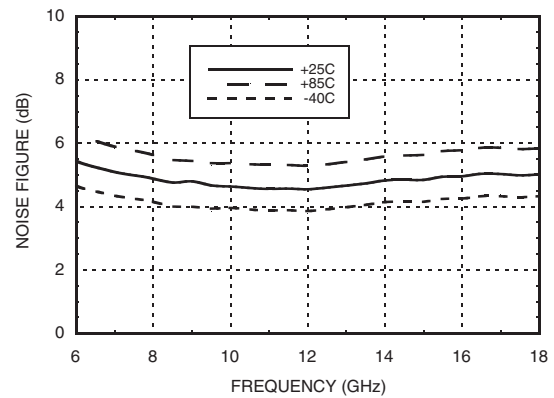

Reverse Isolation vs. Temperature

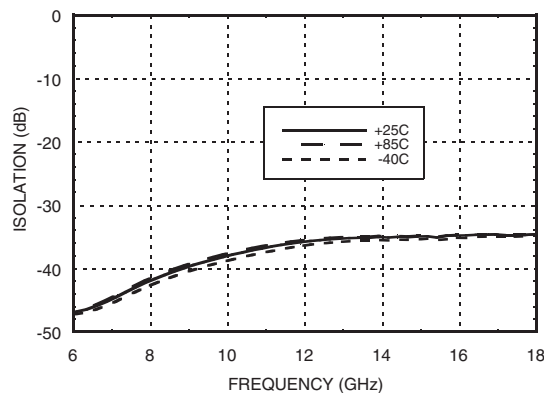

Information furnished by Analog Devices is believed to be accurate and reliable. However, no responsibility is assumed by Analog Devices for its use, nor for any infringements of patents or other rights of third parties that may result from its use. Specifications subject to change without notice. No license is granted by implication or otherwise under any patent or patent rights of Analog Devices. Trademarks and registered trademarks are the property of their respective owners.

For price, delivery, and to place orders: Analog Devices, Inc., One Technology Way, P.O. Box 9106, Norwood, MA 02062-9106 Phone: 781-329-4700 • Order online at www.analog.com Application Support: Phone: 1-800-ANALOG-D

GaAs PHEMT MMIC MEDIUM POWER AMPLIFIER, 7 - 15.5 GHz



Absolute Maximum Ratings

Drain Bias Voltage (Vdd)	+6 Vdc
RF Input Power (RFIN)(Vdd = +5Vdc)	+15 dBm
Channel Temperature	175 °C
Continuous Pdiss (T = 85 °C) (derate 8.4 mW/°C above 85 °C)	0.76 W
Thermal Resistance (channel to ground paddle)	118.8 °C/W
Storage Temperature	-65 to +150 °C
Operating Temperature	-40 to +85 °C

Typical Supply Current vs. Vdd

Vdd (V)	Idd (mA)
+5.5	92
+5.0	90
+4.5	88

Note: Amplifier will operate over full voltage range shown above



ELECTROSTATIC SENSITIVE DEVICE
OBSERVE HANDLING PRECAUTIONS

11

Outline Drawing

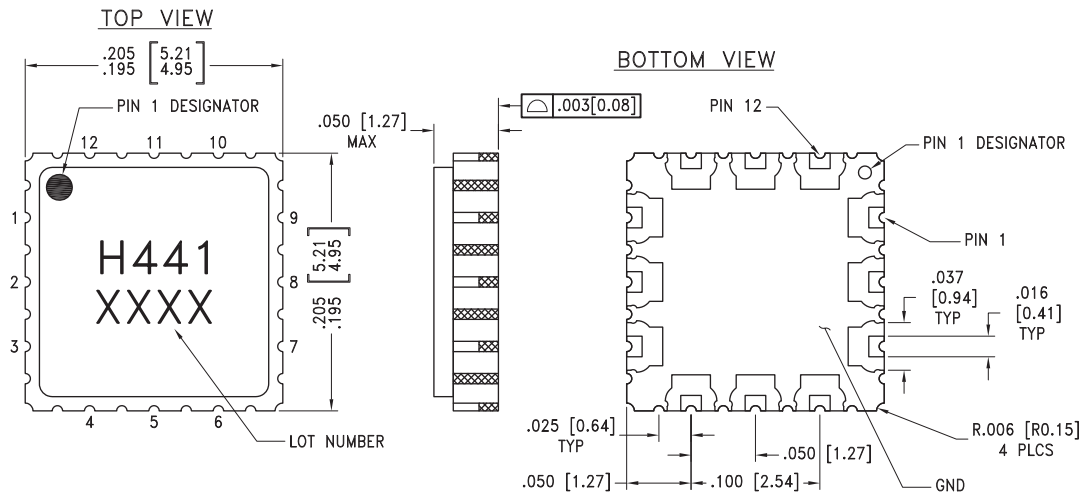

NOTES:

1. PACKAGE BODY MATERIAL: CERAMIC & KOVAR
2. LEAD AND GROUND PADDLE PLATING: GOLD 40 - 80 MICROINCHES.
3. DIMENSIONS ARE IN INCHES [MILLIMETERS].
4. LEAD SPACING TOLERANCE IS NON-CUMULATIVE
5. PAD BURR LENGTH 0.15mm MAX.
PAD BURR HEIGHT 0.25mm MAX.
6. ALL GROUND LEADS AND GROUND PADDLE MUST BE SOLDERED TO PCB RF GROUND.

**GaAs PHEMT MMIC MEDIUM
POWER AMPLIFIER, 7 - 15.5 GHz**



Pin Descriptions

Pin Number	Function	Description	Interface Schematic
1, 3-7, 9, 10, 12	GND	These pins and package bottom must be connected to RF/DC ground.	
2	RFIN	This pin is AC coupled and matched to 50 Ohms.	
8	RFOUT	This pin is AC coupled and matched to 50 Ohms.	
11	Vdd	Power Supply Voltage for the amplifier. External bypass capacitors are recommended.	

Application Circuit

Component	Value
C1	100 pF
C2	1,000 pF
C3	4.7 μF

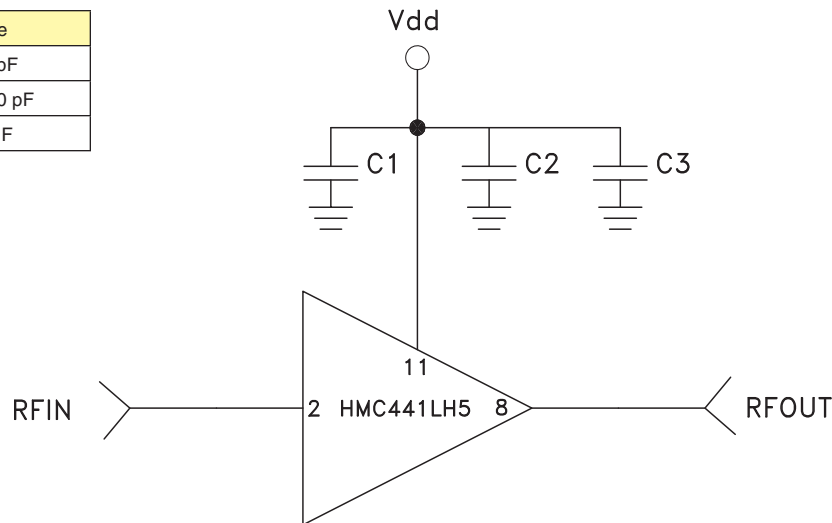

Information furnished by Analog Devices is believed to be accurate and reliable. However, no responsibility is assumed by Analog Devices for its use, nor for any infringements of patents or other rights of third parties that may result from its use. Specifications subject to change without notice. No license is granted by implication or otherwise under any patent or patent rights of Analog Devices. Trademarks and registered trademarks are the property of their respective owners.

For price, delivery, and to place orders: Analog Devices, Inc., One Technology Way, P.O. Box 9106, Norwood, MA 02062-9106 Phone: 781-329-4700 • Order online at www.analog.com Application Support: Phone: 1-800-ANALOG-D

GaAs PHEMT MMIC MEDIUM POWER AMPLIFIER, 7 - 15.5 GHz



Evaluation PCB

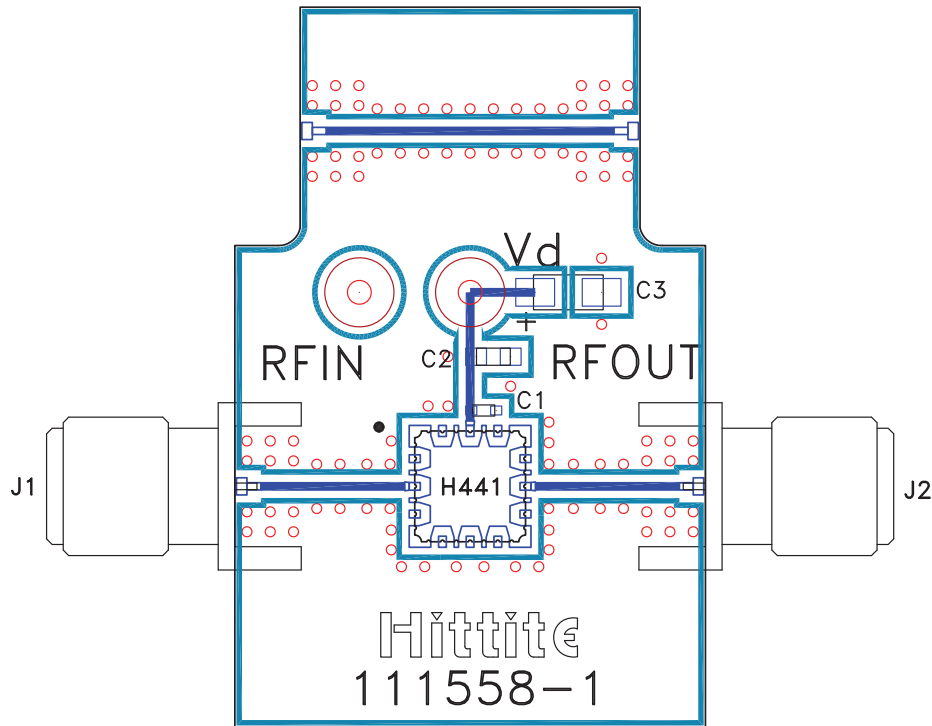

List of Materials for Evaluation PCB 111560 [1]

Item	Description
J1 - J2	PCB Mount SMA RF Connector, SRI
U1	HMC441LH5
C1	100 pF Capacitor, 0402 Pkg.
C2	1,000 pF Capacitor, 0603 Pkg.
C3	4.7 μF Capacitor, Tantalum
PCB [2]	111558 Evaluation Board

[1] Reference this number when ordering complete evaluation PCB

[2] Circuit Board Material: Rogers 4350

The circuit board used in the final application should use RF circuit design techniques. Signal lines should have 50 ohm impedance while the package ground leads and exposed paddle should be connected directly to the ground plane similar to that shown. A sufficient number of via holes should be used to connect the top and bottom ground planes. The evaluation circuit board shown is available from Hittite upon request.