



Chipsmall Limited consists of a professional team with an average of over 10 year of expertise in the distribution of electronic components. Based in Hongkong, we have already established firm and mutual-benefit business relationships with customers from,Europe,America and south Asia,supplying obsolete and hard-to-find components to meet their specific needs.

With the principle of “Quality Parts,Customers Priority,Honest Operation,and Considerate Service”,our business mainly focus on the distribution of electronic components. Line cards we deal with include Microchip,ALPS,ROHM,Xilinx,Pulse,ON,Everlight and Freescale. Main products comprise IC,Modules,Potentiometer,IC Socket,Relay,Connector.Our parts cover such applications as commercial,industrial, and automotives areas.

We are looking forward to setting up business relationship with you and hope to provide you with the best service and solution. Let us make a better world for our industry!



## Contact us

Tel: +86-755-8981 8866 Fax: +86-755-8427 6832

Email & Skype: info@chipsmall.com Web: www.chipsmall.com

Address: A1208, Overseas Decoration Building, #122 Zhenhua RD., Futian, Shenzhen, China





## GaAs PHEMT MMIC MEDIUM POWER AMPLIFIER, 5 - 20 GHz

### Typical Applications

The HMC451LC3 is ideal for use as a medium power amplifier for:

- Microwave Radio & VSAT
- Military & Space
- Test Equipment & Sensors
- Fiber Optics
- LO Driver for HMC Mixers

### Features

- Gain: 19 dB
- Saturated Power: +21 dBm @ 21% PAE
- Output IP3: +30 dBm
- Single Supply: +5V @ 114 mA
- 50 Ohm Matched Input/Output
- RoHS Compliant 3 x 3 mm SMT package

### Functional Diagram

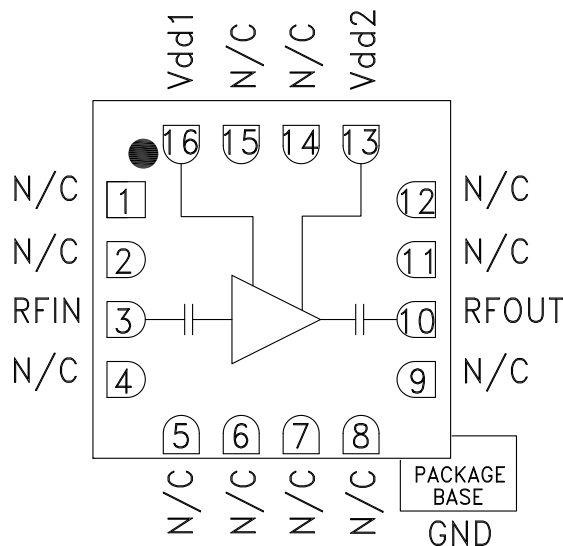

### General Description

The HMC451LC3 is an efficient GaAs PHEMT MMIC Medium Power Amplifier housed in a leadless RoHS compliant SMT package. Operating between 5 and 20 GHz, the amplifier provides 19 dB of gain, +21 dBm of saturated power and 21% PAE from a single +5V supply. This 50 Ohm matched amplifier does not require any external components and the RF I/O's are DC blocked, making it an ideal linear gain block or driver for HMC SMT mixers. The HMC451LC3 allows the use of surface mount manufacturing techniques.

### Electrical Specifications, $T_A = +25^\circ C$ , $V_{dd1} = V_{dd2} = +5V$

| Parameter                                | Min.   | Typ.  | Max.  | Min.    | Typ.  | Max.  | Min.    | Typ.  | Max.  | Units |
|--|--------|-------|-------|---------|-------|-------|---------|-------|-------|-------|
| Frequency Range                          | 5 - 15 |       |       | 15 - 18 |       |       | 18 - 20 |       |       | GHz   |
| Gain                                     | 16     | 19    |       | 15      | 18    |       | 14      | 17    |       | dB    |
| Gain Variation Over Temperature          |        | 0.015 | 0.025 |         | 0.015 | 0.025 |         | 0.015 | 0.025 | dB/°C |
| Input Return Loss                        |        | 13    |       |         | 13    |       |         | 12    |       | dB    |
| Output Return Loss                       |        | 12    |       |         | 8     |       |         | 8     |       | dB    |
| Output Power for 1 dB Compression (P1dB) | 16.5   | 19.5  |       | 16      | 19    |       | 16.5    | 19.5  |       | dBm   |
| Saturated Output Power (Psat)            |        | 21    |       |         | 20.5  |       |         | 21    |       | dBm   |
| Output Third Order Intercept (IP3)       |        | 32    |       |         | 29    |       |         | 29    |       | dBm   |
| Noise Figure                             |        | 7     |       |         | 6.5   |       |         | 7     |       | dB    |
| Supply Current (Idd)                     |        | 114   |       |         | 114   |       |         | 114   |       | mA    |

# HMC451LC3\* PRODUCT PAGE QUICK LINKS

Last Content Update: 02/23/2017

---

## COMPARABLE PARTS

View a parametric search of comparable parts.

## EVALUATION KITS

- HMC451LC3 Evaluation Board

## DOCUMENTATION

### Application Notes

- AN-1363: Meeting Biasing Requirements of Externally Biased RF/Microwave Amplifiers with Active Bias Controllers
- Broadband Biasing of Amplifiers General Application Note
- MMIC Amplifier Biasing Procedure Application Note
- Thermal Management for Surface Mount Components General Application Note

### Data Sheet

- HMC451LC3 Data Sheet

## TOOLS AND SIMULATIONS

- HMC451LC3 S-Parameters

## REFERENCE MATERIALS

### Quality Documentation

- Package/Assembly Qualification Test Report: LC3, LC3B, LC3C (QTR: 2014-00376 REV: 01)
- Semiconductor Qualification Test Report: PHEMT-F (QTR: 2013-00269)

## DESIGN RESOURCES

- HMC451LC3 Material Declaration
- PCN-PDN Information
- Quality And Reliability
- Symbols and Footprints

## DISCUSSIONS

View all HMC451LC3 EngineerZone Discussions.

## SAMPLE AND BUY

Visit the product page to see pricing options.

## TECHNICAL SUPPORT

Submit a technical question or find your regional support number.

## DOCUMENT FEEDBACK

Submit feedback for this data sheet.

---



**GaAs PHEMT MMIC MEDIUM  
POWER AMPLIFIER, 5 - 20 GHz**

**Broadband Gain & Return Loss**

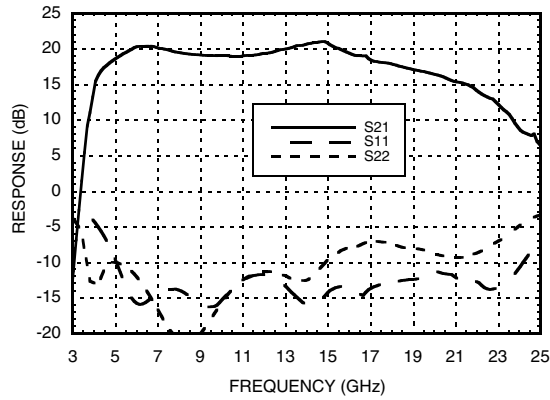

**Gain vs. Temperature**

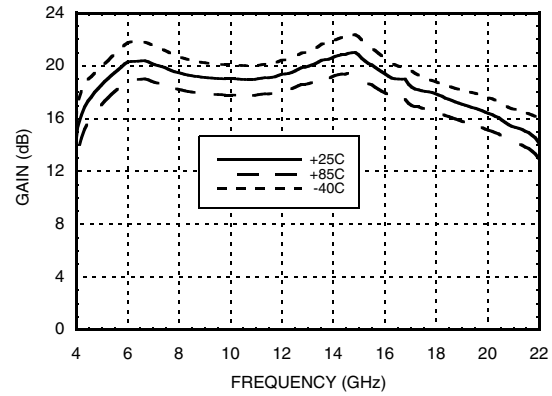

**Input Return Loss vs. Temperature**

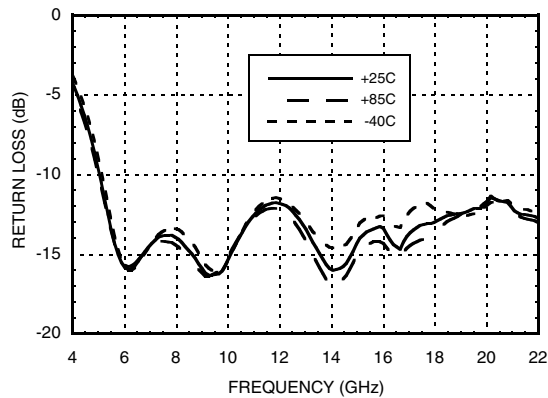

**Output Return Loss vs. Temperature**

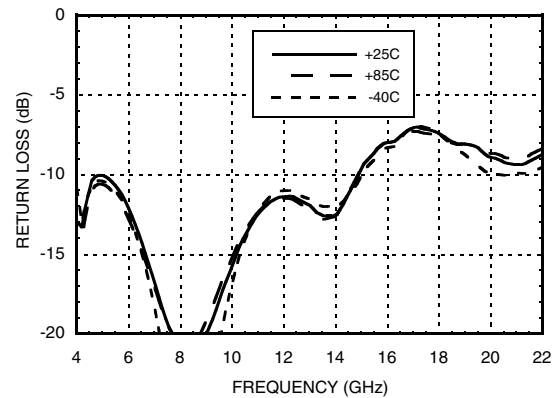

**P1dB vs. Temperature**

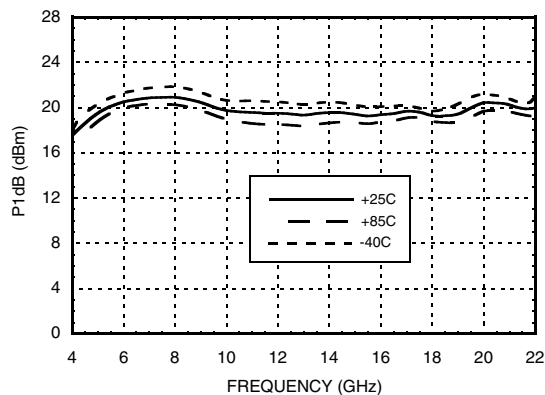

**Psat vs. Temperature**

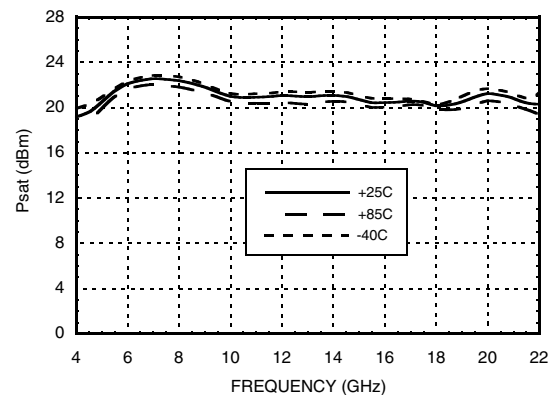



**GaAs PHEMT MMIC MEDIUM POWER AMPLIFIER, 5 - 20 GHz**

**Power Compression @ 10 GHz**

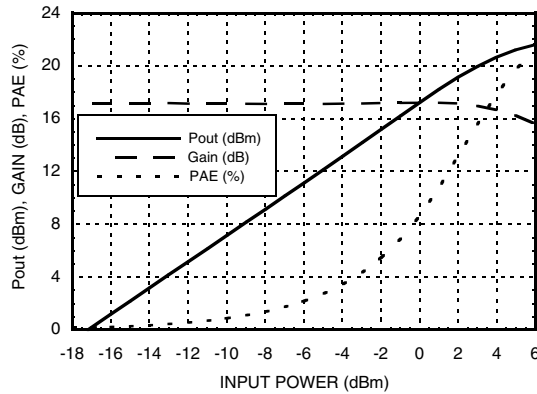

**Power Compression @ 20 GHz**

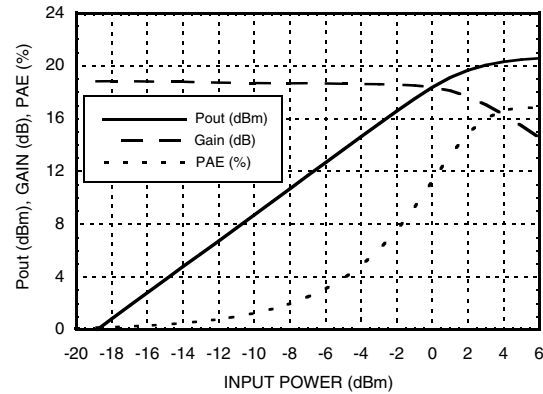

**Output IP3 vs. Temperature**

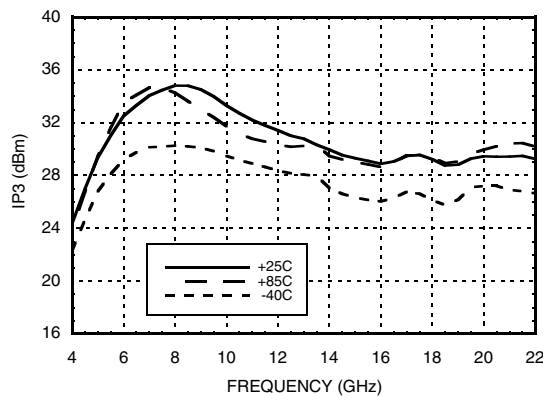

**Noise Figure vs. Temperature**

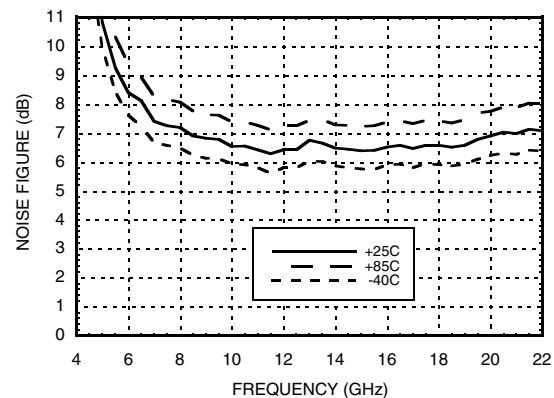

**Gain, P1dB & PSAT vs. Supply Voltage @ 11 GHz**

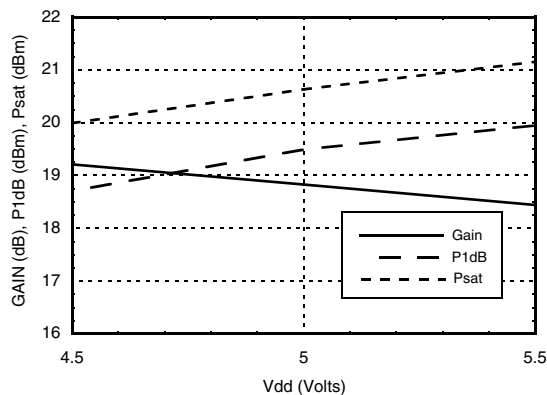

**Reverse Isolation vs. Temperature**

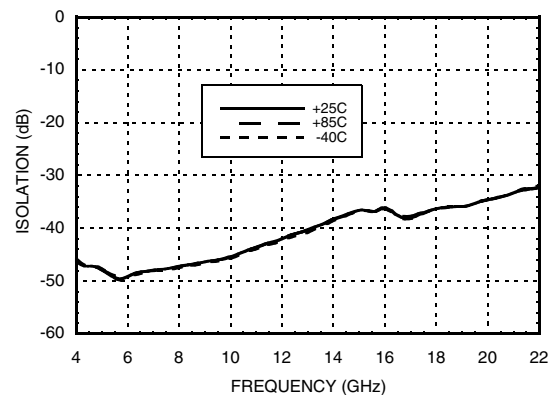

Information furnished by Analog Devices is believed to be accurate and reliable. However, no responsibility is assumed by Analog Devices for its use, nor for any infringements of patents or other rights of third parties that may result from its use. Specifications subject to change without notice. No license is granted by implication or otherwise under any patent or patent rights of Analog Devices. Trademarks and registered trademarks are the property of their respective owners.

For price, delivery, and to place orders: Analog Devices, Inc., One Technology Way, P.O. Box 9106, Norwood, MA 02062-9106 Phone: 781-329-4700 • Order online at [www.analog.com](http://www.analog.com) Application Support: Phone: 1-800-ANALOG-D



## GaAs PHEMT MMIC MEDIUM POWER AMPLIFIER, 5 - 20 GHz

### Absolute Maximum Ratings

|   |                |
|---|----------------|
| Drain Bias Voltage (Vdd <sub>1</sub> = Vdd <sub>2</sub> )       | +5.5 Vdc       |
| RF Input Power (RFIN)(Vdd = +5Vdc)                              | +10 dBm        |
| Channel Temperature   | 175 °C         |
| Continuous Pdiss (T = 85 °C)<br>(derate 12.4 mW/°C above 85 °C) | 1.1 W          |
| Thermal Resistance<br>(channel to ground paddle)                | 80 °C/W        |
| Storage Temperature   | -65 to +150 °C |
| Operating Temperature   | -40 to +85 °C  |

### Typical Supply Current vs. Vdd<sub>1</sub> = Vdd<sub>2</sub>

| Vdd <sub>1</sub> = Vdd <sub>2</sub> (V) | Idd <sub>1</sub> = Idd <sub>2</sub> (mA) |
|---|--|
| +4.5                                    | 111                                      |
| +5.0                                    | 114                                      |
| +5.5                                    | 116                                      |

Note: Amplifier will operate over full voltage range shown above



ELECTROSTATIC SENSITIVE DEVICE  
OBSERVE HANDLING PRECAUTIONS

### Outline Drawing

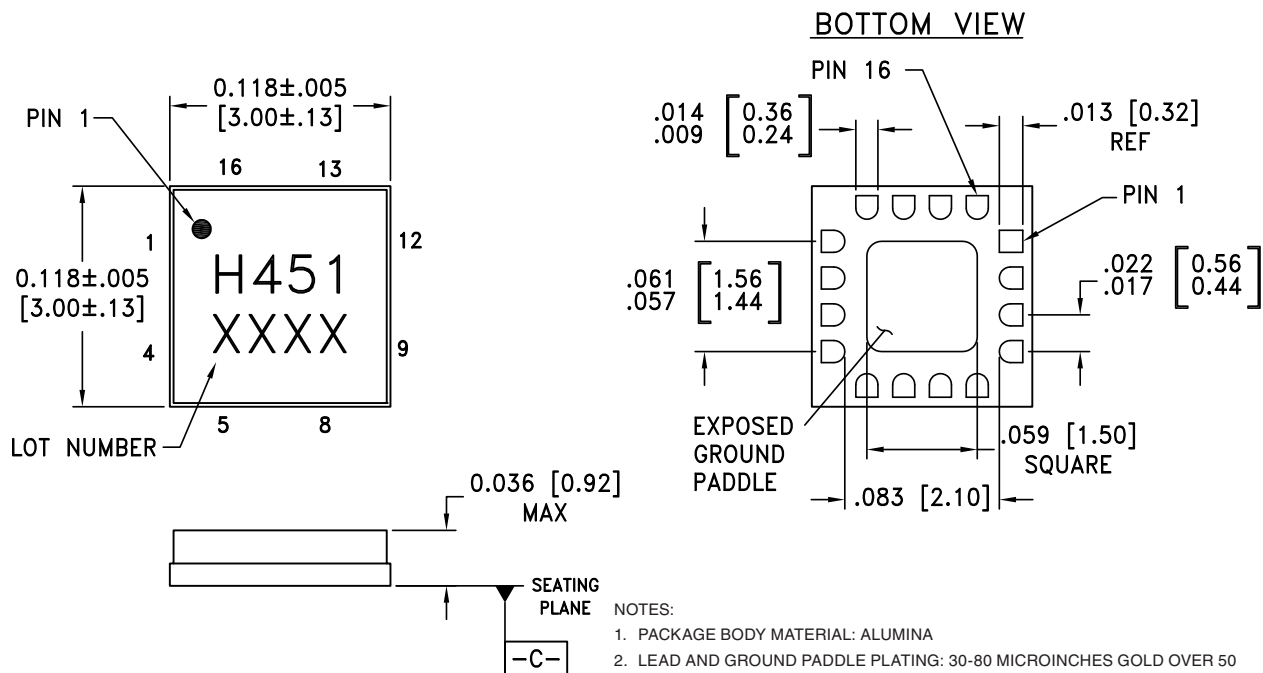

### Package Information

| Part Number | Package Body Material | Lead Finish      | MSL Rating | Package Marking [2] |
|-------------|-----------------------|------------------|------------|---------------------|
| HMC451LC3   | Alumina, White        | Gold over Nickel | MSL3 [1]   | H451<br>XXXX        |

[1] Max peak reflow temperature of 260 °C

[2] 4-Digit lot number XXXX



## GaAs PHEMT MMIC MEDIUM POWER AMPLIFIER, 5 - 20 GHz

### Pin Descriptions

| Pin Number                  | Function | Description   | Interface Schematic |
|-----------------------------|----------|---|---------------------|
| 1, 2, 4 - 9, 11, 12, 14, 15 | N/C      | This pin may be connected to RF/DC ground. Performance will not be affected.                                    |                     |
| 3                           | RFIN     | This pin is AC coupled and matched to 50 Ohms from 5 - 20 GHz.  | RFIN                |
| 10                          | RFOUT    | This pin is AC coupled and matched to 50 Ohms from 5 - 20 GHz.  | RFOUT               |
| 13                          | Vdd2     | Power Supply Voltage for the amplifier. External bypass capacitors of 100 pF, 1,000 pF and 2.2 μF are required. |                     |
| 16                          | Vdd1     | Power Supply Voltage for the amplifier. External bypass capacitors of 100 pF, 1,000 pF and 2.2 μF are required. |                     |
|                             | GND      | Package bottom must be connected to RF/DC ground.   |                     |

### Application Circuit

| Component | Value    |
|-----------|----------|
| C1, C2    | 100 pF   |
| C3, C4    | 1,000 pF |
| C5, C6    | 2.2 μF   |

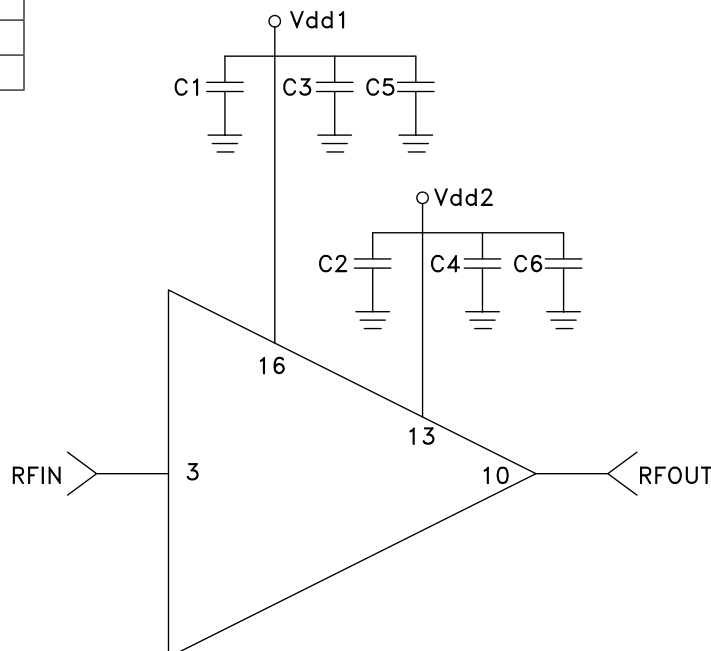

Information furnished by Analog Devices is believed to be accurate and reliable. However, no responsibility is assumed by Analog Devices for its use, nor for any infringements of patents or other rights of third parties that may result from its use. Specifications subject to change without notice. No license is granted by implication or otherwise under any patent or patent rights of Analog Devices. Trademarks and registered trademarks are the property of their respective owners.

For price, delivery, and to place orders: Analog Devices, Inc., One Technology Way, P.O. Box 9106, Norwood, MA 02062-9106 Phone: 781-329-4700 • Order online at [www.analog.com](http://www.analog.com) Application Support: Phone: 1-800-ANALOG-D

## GaAs PHEMT MMIC MEDIUM POWER AMPLIFIER, 5 - 20 GHz



### Evaluation PCB

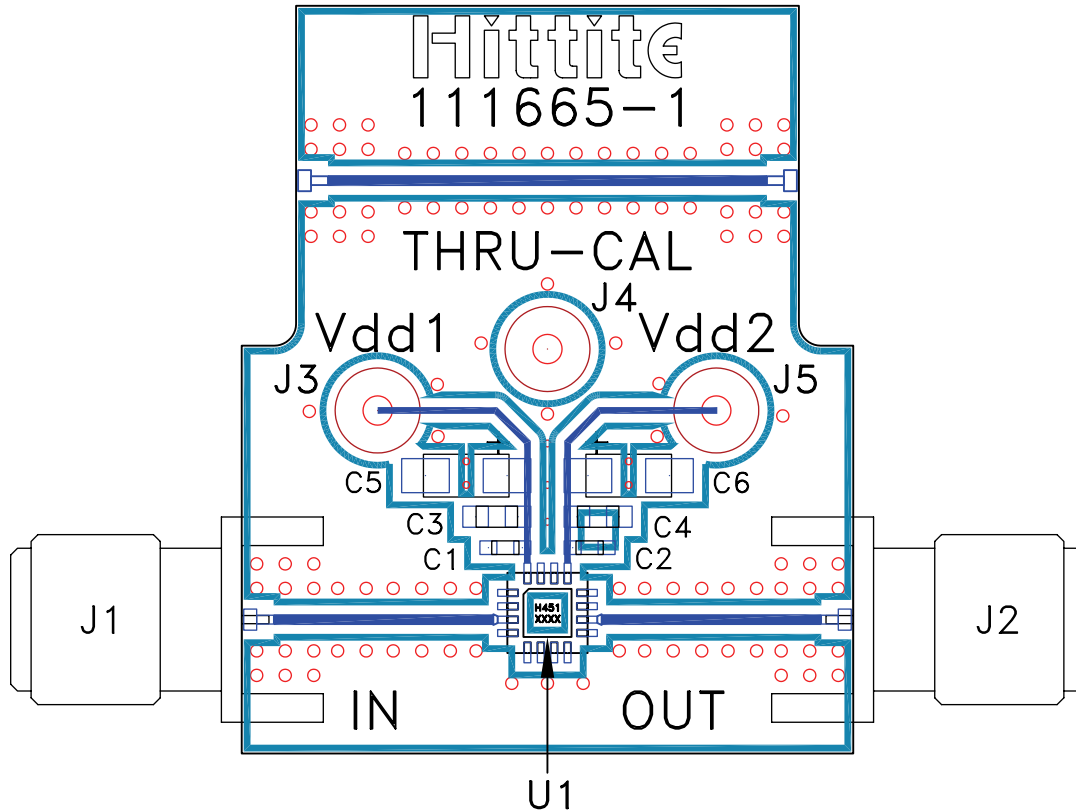

### List of Materials for Evaluation PCB 111667 [1]

| Item    | Description                    |
|---------|--------------------------------|
| J1 - J2 | PCB Mount SMA Connector        |
| J3 - J5 | DC Pin                         |
| C1, C2  | 100 pF Capacitor, 0402 Pkg.    |
| C3, C4  | 1000 pF Capacitor, 0603 Pkg.   |
| C5, C6  | 2.2 μF Capacitor, Tantalum     |
| U1      | HMC451LC3 Amplifier            |
| PCB [2] | 111665 Evaluation PCB, 10 mils |

[1] Reference this number when ordering complete evaluation PCB

[2] Circuit Board Material: Rogers 4350

The circuit board used in the final application should use RF circuit design techniques. Signal lines should have 50 Ohm impedance while the package ground leads and exposed paddle should be connected directly to the ground plane similar to that shown. A sufficient number of via holes should be used to connect the top and bottom ground planes. The evaluation board should be mounted to an appropriate heat sink. The evaluation circuit board shown is available from Hittite upon request.