



Chipsmall Limited consists of a professional team with an average of over 10 year of expertise in the distribution of electronic components. Based in Hongkong, we have already established firm and mutual-benefit business relationships with customers from,Europe,America and south Asia,supplying obsolete and hard-to-find components to meet their specific needs.

With the principle of “Quality Parts,Customers Priority,Honest Operation,and Considerate Service”,our business mainly focus on the distribution of electronic components. Line cards we deal with include Microchip,ALPS,ROHM,Xilinx,Pulse,ON,Everlight and Freescale. Main products comprise IC,Modules,Potentiometer,IC Socket,Relay,Connector.Our parts cover such applications as commercial,industrial, and automotives areas.

We are looking forward to setting up business relationship with you and hope to provide you with the best service and solution. Let us make a better world for our industry!



Contact us

Tel: +86-755-8981 8866 Fax: +86-755-8427 6832

Email & Skype: info@chipsmall.com Web: www.chipsmall.com

Address: A1208, Overseas Decoration Building, #122 Zhenhua RD., Futian, Shenzhen, China





SiGe HBT GAIN BLOCK MMIC AMPLIFIER, DC - 6 GHz

Typical Applications

The HMC476MP86 / HMC476MP86E is an ideal RF/IF gain block & LO or PA driver for:

- Cellular / PCS / 3G
- Fixed Wireless & WLAN
- CATV, Cable Modem & DBS
- Microwave Radio & Test Equipment

Features

- P1dB Output Power: +12 dBm
- Gain: 20 dB
- Output IP3: +25 dBm
- Cascadable 50 Ohm I/Os
- Single Supply: +5V to +12V
- Included in the HMC-DK001 Designer's Kit

Functional Diagram

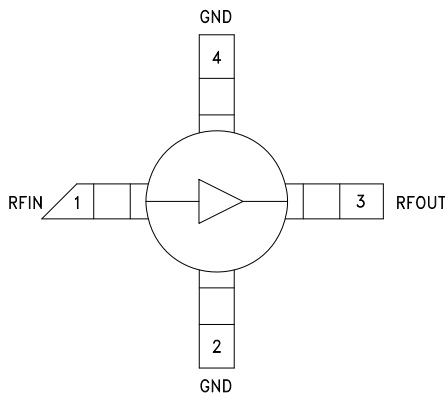

General Description

The HMC476MP86 & HMC476MP86E are SiGe Heterojunction Bipolar Transistor (HBT) Gain Block MMIC SMT amplifiers covering DC to 6 GHz. This Micro-P packaged amplifier can be used as a cascadable 50 Ohm RF/IF gain stage as well as a LO or PA driver with up to +13 dBm output power. The HMC476MP86 & HMC476MP86E offers 20 dB of gain with a +25 dBm output IP3 at 850 MHz while requiring only 35 mA from a single positive supply. The Darlington feedback pair used results in reduced sensitivity to normal process variations and excellent gain stability over temperature while requiring a minimal number of external bias components.

Electrical Specifications, $V_s = 5V$, $R_{bias} = 56 \text{ Ohm}$, $T_A = +25^\circ \text{ C}$

Parameter		Min.	Typ.	Max.	Units
Gain	DC - 1.0 GHz	18.5	20.0		dB
	1.0 - 2.0 GHz	15.5	17.0		dB
	2.0 - 3.0 GHz	13.5	15.0		dB
	3.0 - 4.0 GHz	11.5	13.0		dB
	4.0 - 6.0 GHz	9.0	10.5		dB
Gain Variation Over Temperature	DC - 6 GHz		0.008	0.012	dB/ °C
Input Return Loss	DC - 1.0 GHz		20		dB
	1.0 - 6.0 GHz		15		dB
Output Return Loss	DC - 4.5 GHz		20		dB
	4.5 - 6.0 GHz		13		dB
Reverse Isolation	DC - 6 GHz		18		dB
Output Power for 1 dB Compression (P1dB)	0.5 - 5.0 GHz	9.0	12.0		dBm
	5.0 - 6.0 GHz	8.0	11.0		dBm
Output Third Order Intercept (IP3) (Pout= 0 dBm per tone, 1 MHz spacing)	DC - 5 GHz		25		dBm
	5.0 - 6.0 GHz		23		dBm
Noise Figure	DC - 3.0 GHz		2.5		dB
	3.0 - 6.0 GHz		3.5		dB
Supply Current (Icq)			35		mA

Note: Data taken with broadband bias tee on device output.

Information furnished by Analog Devices is believed to be accurate and reliable. However, no responsibility is assumed by Analog Devices for its use, nor for any infringements of patents or other rights of third parties that may result from its use. Specifications subject to change without notice. No license is granted by implication or otherwise under any patent or patent rights of Analog Devices. Trademarks and registered trademarks are the property of their respective owners.

For price, delivery, and to place orders: Analog Devices, Inc., One Technology Way, P.O. Box 9106, Norwood, MA 02062-9106
Phone: 781-329-4700 • Order online at www.analog.com
Application Support: Phone: 1-800-ANALOG-D

HMC476MP86* PRODUCT PAGE QUICK LINKS

Last Content Update: 02/23/2017

COMPARABLE PARTS

View a parametric search of comparable parts.

EVALUATION KITS

- HMC476MP86 Evaluation Board

DOCUMENTATION

Data Sheet

- HMC476MP86: SiGe HBT Gain Block MMIC Amplifier, DC - 6 GHz Data Sheet [Data Sheet](#)

TOOLS AND SIMULATIONS

- HMC476MP86 S-Parameters

DESIGN RESOURCES

- HMC476MP86 Material Declaration
- PCN-PDN Information
- Quality And Reliability
- Symbols and Footprints

DISCUSSIONS

View all HMC476MP86 EngineerZone Discussions.

SAMPLE AND BUY

Visit the product page to see pricing options.

TECHNICAL SUPPORT

Submit a technical question or find your regional support number.

DOCUMENT FEEDBACK

Submit feedback for this data sheet.



**SiGe HBT GAIN BLOCK
MMIC AMPLIFIER, DC - 6 GHz**

Broadband Gain & Return Loss

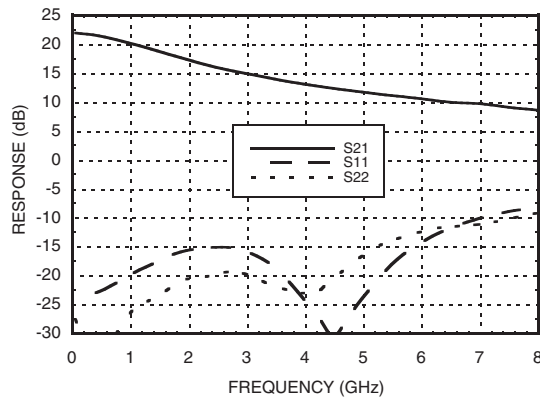

Gain vs. Temperature

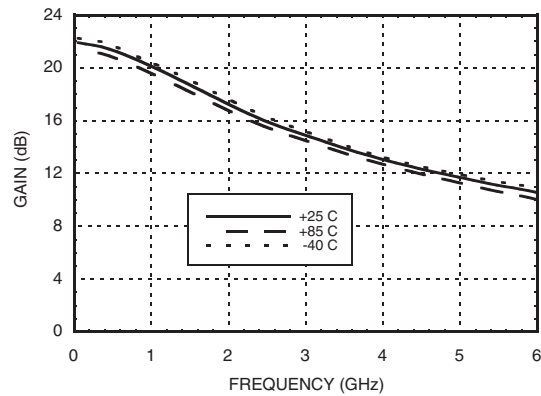

Input Return Loss vs. Temperature

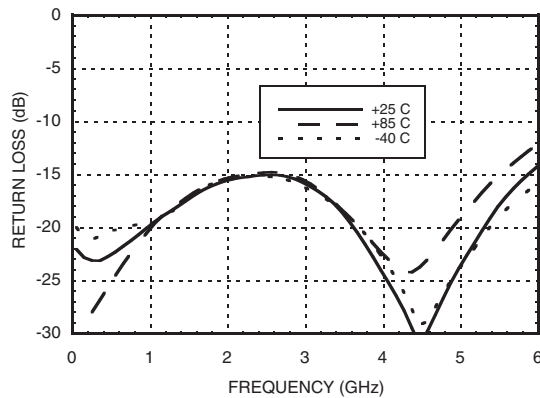

Output Return Loss vs. Temperature

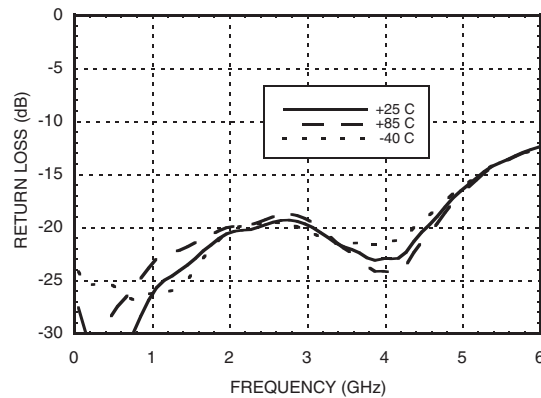

Reverse Isolation vs. Temperature

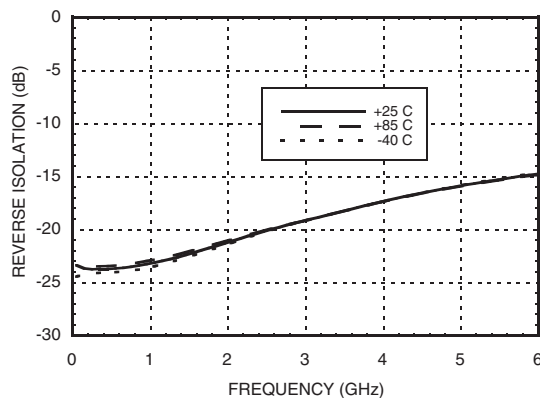

Noise Figure vs. Temperature

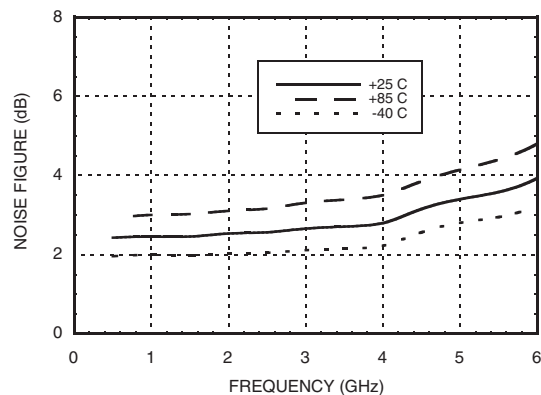

Information furnished by Analog Devices is believed to be accurate and reliable. However, no responsibility is assumed by Analog Devices for its use, nor for any infringements of patents or other rights of third parties that may result from its use. Specifications subject to change without notice. No license is granted by implication or otherwise under any patent or patent rights of Analog Devices. Trademarks and registered trademarks are the property of their respective owners.

For price, delivery, and to place orders: Analog Devices, Inc., One Technology Way, P.O. Box 9106, Norwood, MA 02062-9106 Phone: 781-329-4700 • Order online at www.analog.com Application Support: Phone: 1-800-ANALOG-D



**SiGe HBT GAIN BLOCK
MMIC AMPLIFIER, DC - 6 GHz**

8

AMPLIFIERS - DRIVER & GAIN BLOCK - SMT

P1dB vs. Temperature

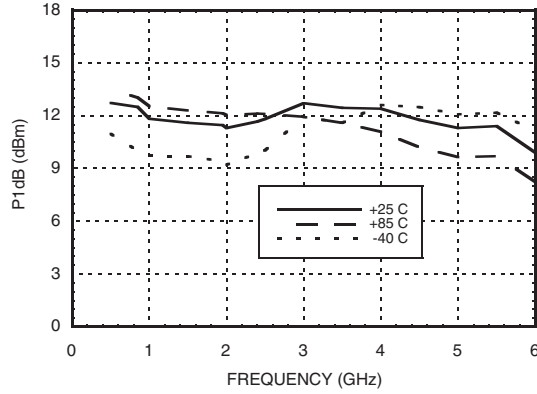

Psat vs. Temperature

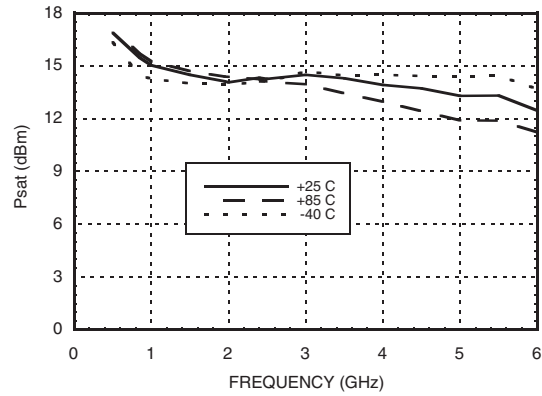

Output IP3 vs. Temperature

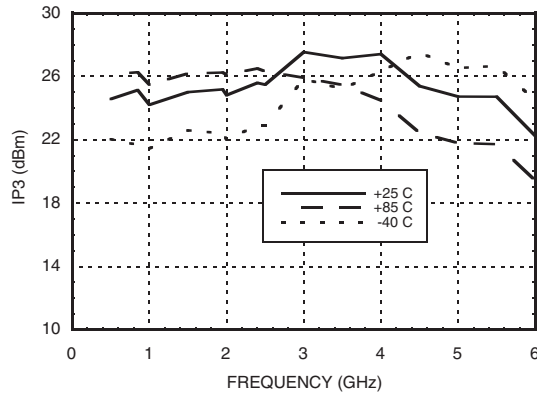

Gain, Power & OIP3 vs. Supply Voltage for Constant Id= 35 mA @ 850 MHz

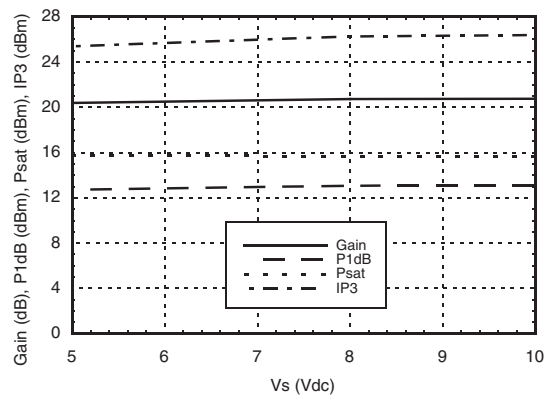

Vcc vs. Icc Over Temperature for Fixed Vs= 5V, RBIAS= 56 Ohms

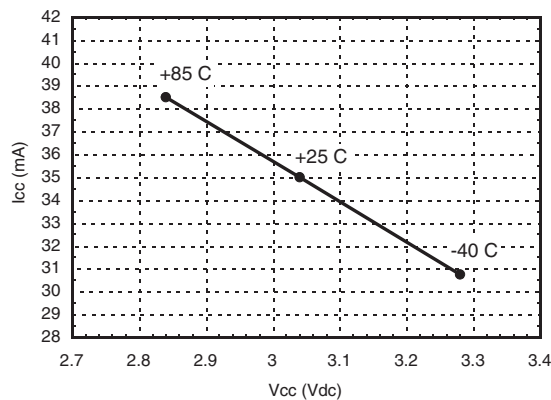

Information furnished by Analog Devices is believed to be accurate and reliable. However, no responsibility is assumed by Analog Devices for its use, nor for any infringements of patents or other rights of third parties that may result from its use. Specifications subject to change without notice. No license is granted by implication or otherwise under any patent or patent rights of Analog Devices. Trademarks and registered trademarks are the property of their respective owners.

For price, delivery, and to place orders: Analog Devices, Inc., One Technology Way, P.O. Box 9106, Norwood, MA 02062-9106 Phone: 781-329-4700 • Order online at www.analog.com Application Support: Phone: 1-800-ANALOG-D



SiGe HBT GAIN BLOCK MMIC AMPLIFIER, DC - 6 GHz

Absolute Maximum Ratings

Collector Bias Voltage (Vcc)	+6.0 Vdc
Collector Bias Current (Icc)	45 mA
RF Input Power (RFIN)(Vcc = +3.0 Vdc)	+5 dBm
Junction Temperature	150 °C
Continuous Pdiss (T = 85 °C) (derate 7.75 mW/°C above 85 °C)	0.504 W
Thermal Resistance (junction to lead)	129 °C/W
Storage Temperature	-65 to +150 °C
Operating Temperature	-40 to +85 °C



ELECTROSTATIC SENSITIVE DEVICE
OBSERVE HANDLING PRECAUTIONS

Outline Drawing

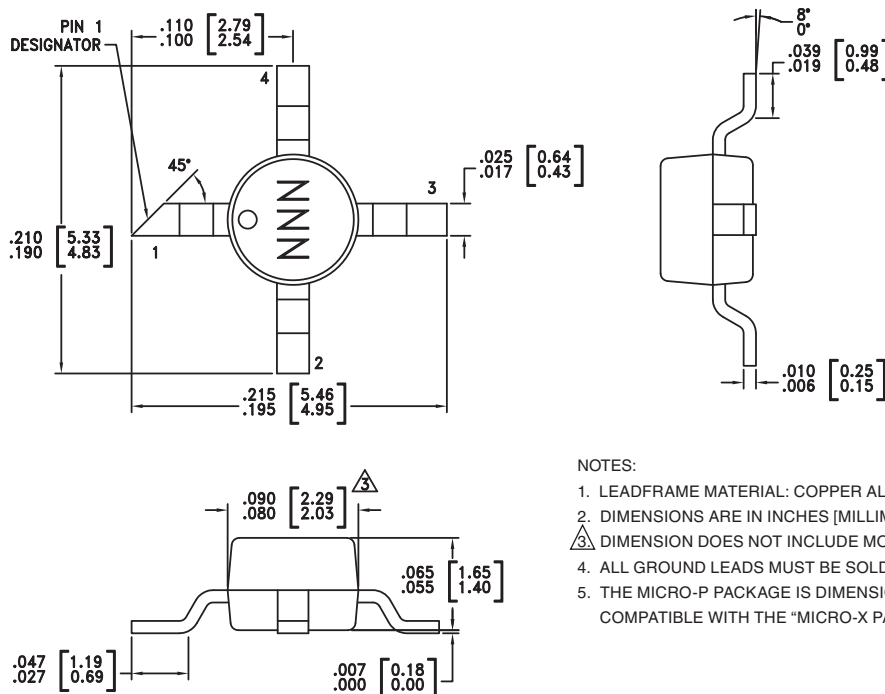

NOTES:

1. LEADFRAME MATERIAL: COPPER ALLOY
2. DIMENSIONS ARE IN INCHES [MILLIMETERS]
3. DIMENSION DOES NOT INCLUDE MOLDFLASH OF 0.15mm PER SIDE.
4. ALL GROUND LEADS MUST BE SOLDERED TO PCB RF GROUND.
5. THE MICRO-P PACKAGE IS DIMENSIONALLY COMPATIBLE WITH THE "MICRO-X PACKAGE"

Package Information

Part Number	Package Body Material	Lead Finish	MSL Rating	Package Marking
HMC476MP86	Low Stress Injection Molded Plastic	Sn/Pb Solder	MSL1 [1]	476
HMC476MP86E	RoHS-compliant Low Stress Injection Molded Plastic	100% matte Sn	MSL1 [2]	476

[1] Max peak reflow temperature of 235 °C

[2] Max peak reflow temperature of 260 °C



Pin Descriptions

Pin Number	Function	Description	Interface Schematic
1	RFIN	This pin is DC coupled. An off chip DC blocking capacitor is required.	
3	RFOUT	RF output and DC Bias (Vcc) for the output stage.	
2, 4	GND	These pins must be connected to RF/DC ground.	

Application Circuit

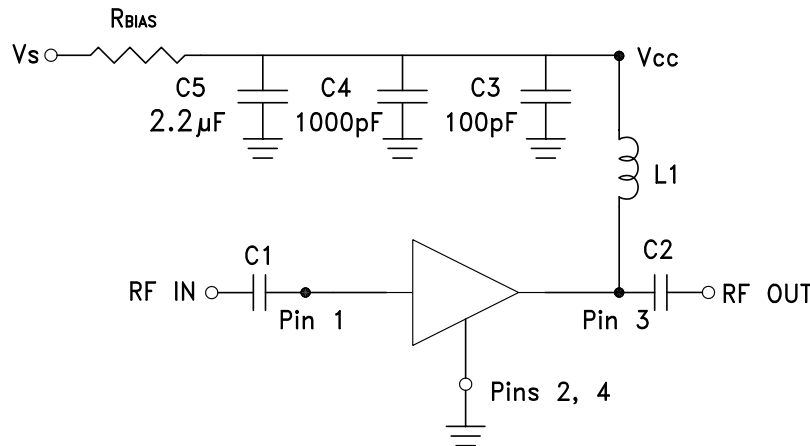

Recommended Bias Resistor Values for $I_{cc} = 35 \text{ mA}$, $R_{bias} = (V_s - V_{cc}) / I_{cc}$

Supply Voltage (Vs)	5V	8V	10V	12V
RBIAS VALUE	56 Ω	130 Ω	180 Ω	240 Ω
RBIAS POWER RATING	1/8 W	1/4 W	1/4 W	1/2 W

Note:

- External blocking capacitors are required on RFIN and RFOUT.
- RBIAS provides DC bias stability over temperature.

Recommended Component Values for Key Application Frequencies

Component	Frequency (MHz)							
	50	900	1900	2200	2400	3500	5200	5800
L1	270 nH	56 nH	18 nH	18 nH	15 nH	8.2 nH	6.8 nH	3.3 nH
C1, C2	0.01 µF	100 pF	100 pF	100 pF	100 pF	100 pF	100 pF	100 pF



Evaluation PCB

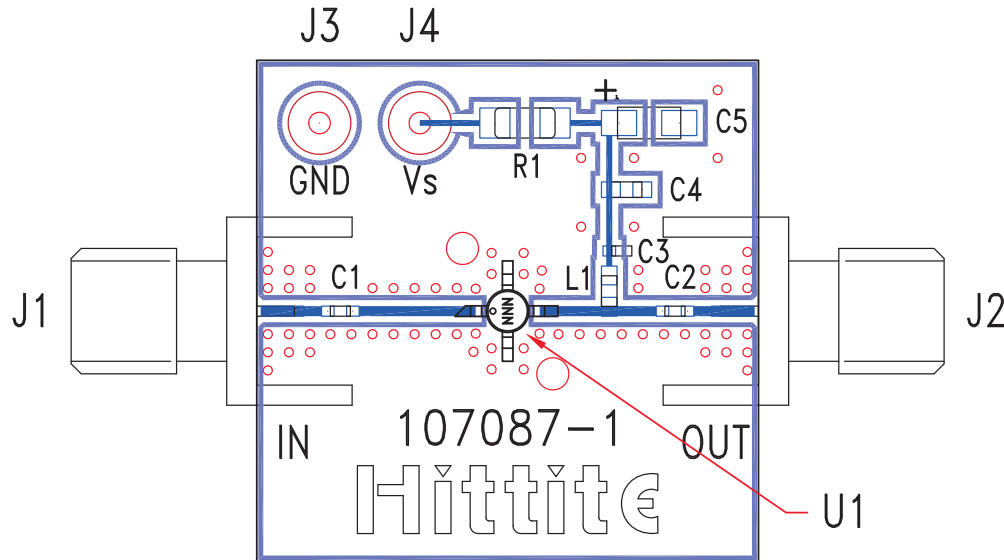

List of Materials for Evaluation PCB 107487 [1]

Item	Description
J1 - J2	PCB Mount SMA Connector
J3 - J4	DC Pin
C1, C2	Capacitor, 0402 Pkg.
C3	100 pF Capacitor, 0402 Pkg.
C4	1000 pF Capacitor, 0603 Pkg.
C5	2.2 μ F Capacitor, Tantalum
R1	Resistor, 1210 Pkg.
L1	Inductor, 0603 Pkg.
U1	HMC476MP86 / HMC476MP86E
PCB [2]	107087 Evaluation PCB

[1] Reference this number when ordering complete evaluation PCB

[2] Circuit Board Material: Rogers 4350

The circuit board used in the application should use RF circuit design techniques. Signal lines should have 50 Ohm impedance while the package ground leads should be connected directly to the ground plane similar to that shown. A sufficient number of via holes should be used to connect the top and bottom ground planes. The evaluation board should be mounted to an appropriate heat sink. The evaluation circuit board shown is available from Hittite upon request.