



Chipsmall Limited consists of a professional team with an average of over 10 year of expertise in the distribution of electronic components. Based in Hongkong, we have already established firm and mutual-benefit business relationships with customers from,Europe,America and south Asia,supplying obsolete and hard-to-find components to meet their specific needs.

With the principle of “Quality Parts,Customers Priority,Honest Operation,and Considerate Service”,our business mainly focus on the distribution of electronic components. Line cards we deal with include Microchip,ALPS,ROHM,Xilinx,Pulse,ON,Everlight and Freescale. Main products comprise IC,Modules,Potentiometer,IC Socket,Relay,Connector.Our parts cover such applications as commercial,industrial, and automotives areas.

We are looking forward to setting up business relationship with you and hope to provide you with the best service and solution. Let us make a better world for our industry!



## Contact us

Tel: +86-755-8981 8866 Fax: +86-755-8427 6832

Email & Skype: info@chipsmall.com Web: www.chipsmall.com

Address: A1208, Overseas Decoration Building, #122 Zhenhua RD., Futian, Shenzhen, China



## GaAs MMIC MIXER W/ INTEGRATED LO AMPLIFIER, 4 - 7 GHz



### Typical Applications

The HMC488MS8G / HMC488MS8GE is ideal for:

- Basestations & Repeaters
- Access Points & Subscribers
- UNII, ISM, WLAN & WiMAX
- Point to Point/Multi-Point Radios
- VSAT Radio

### Features

- Low Conversion Loss: 7 dB
- Double-Balanced Topology
- Integrated LO Amplifier: 0 to +6 dBm Drive
- Input IP3: +15 dBm
- Single Supply: +5V @ 46 mA
- MSOP8-G Package: 14.8 mm<sup>2</sup>

### Functional Diagram

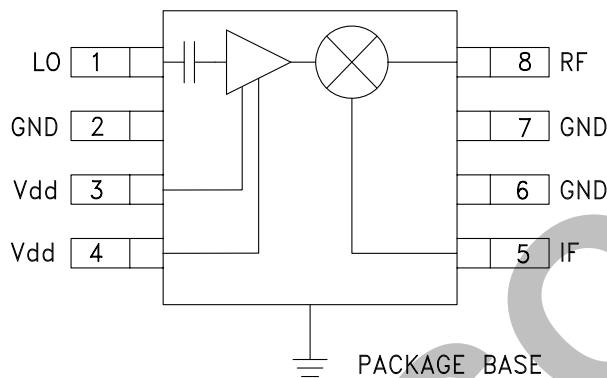

### General Description

The HMC488MS8G(E) is an ultra miniature double-balanced mixer with integrated LO amplifier in an 8 lead plastic SMT MSOP8-G covering 4 - 7 GHz. This passive MMIC mixer integrates a GaAs Schottky diode quad, transformer baluns and a LO buffer on a single chip yielding a low conversion loss of 7 dB coupled with an input IP3 of +15 dBm. The LO buffer amplifier can be driven from 0 to +6 dBm and requires a single supply of +5V @ 46 mA. The device can be used as an upconverter, downconverter or bi-phase (de)modulator for a variety of point-to-point/multipoint, VSAT, telemetry or broadband WLAN applications.

### Electrical Specifications, $T_A = +25^\circ\text{C}$ , $IF = 100\text{ MHz}$ , $V_{dd} = 5\text{V}$

Parameter	LO = +2 dBm			LO = 0 dBm			Units
	Min.	Typ.	Max.	Min.	Typ.	Max.	
Frequency Range, RF & LO	4 - 7			5 - 6			GHz
Frequency Range, IF	DC - 2.5			DC - 2.5			GHz
Conversion Loss		7	9.5		8	10.5	dB
Noise Figure (SSB)		7			8		dB
LO to RF Isolation	25	30		27	32		dB
LO to IF Isolation	16	20		20	25		dB
IP3 (Input)		15			15		dBm
1 dB Gain Compression (Input)	5	8		6	9		dBm
Supply Current (I <sub>dd</sub> )		46	60		46	60	mA



**Conversion Gain vs. Temperature @ LO = +2 dBm**

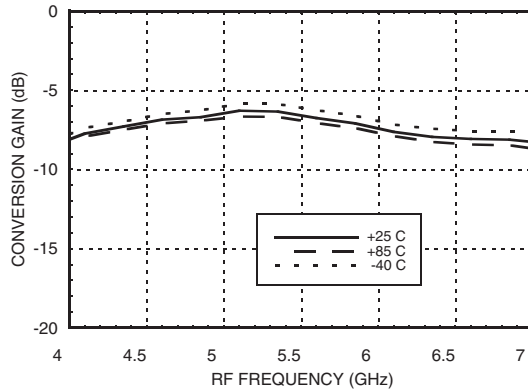

**Isolation @ LO = +2 dBm**

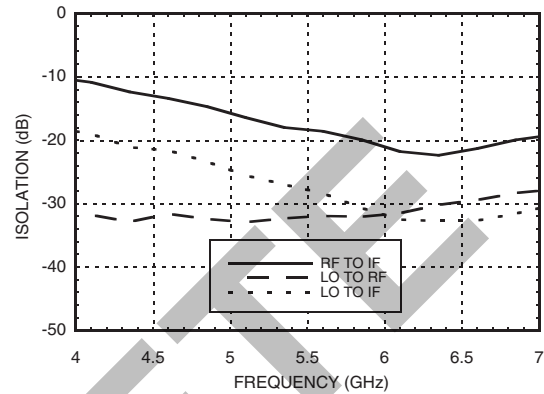

**Conversion Gain vs. LO Drive**

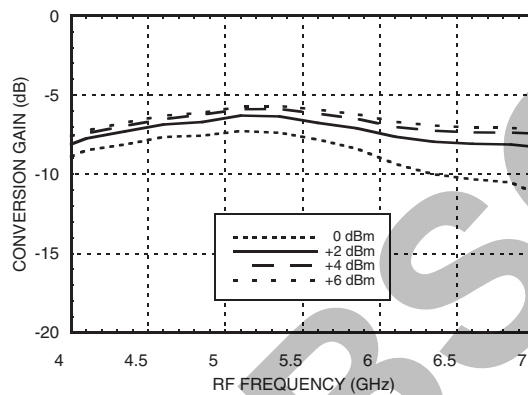

**Return Loss @ LO = +2 dBm**

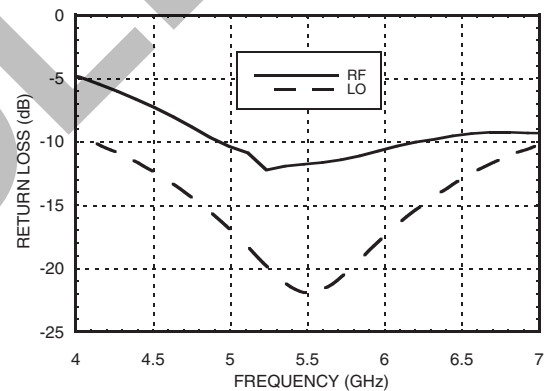

**Upconverter Performance Conversion Gain vs. LO Drive**

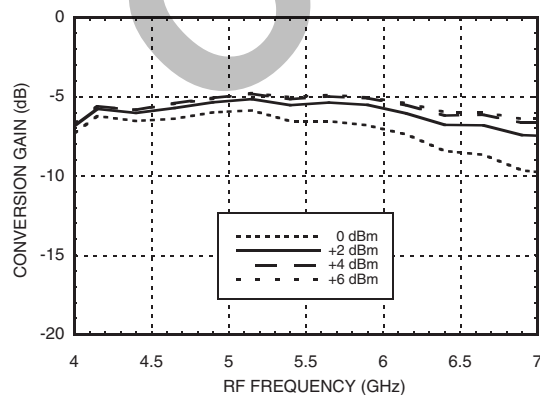

**IF Bandwidth @ LO = +2 dBm**

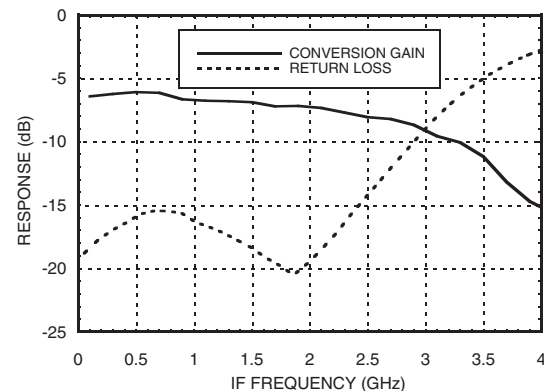

Information furnished by Analog Devices is believed to be accurate and reliable. However, no responsibility is assumed by Analog Devices for its use, nor for any infringements of patents or other rights of third parties that may result from its use. Specifications subject to change without notice. No license is granted by implication or otherwise under any patent or patent rights of Analog Devices. Trademarks and registered trademarks are the property of their respective owners.

For price, delivery, and to place orders: Analog Devices, Inc., One Technology Way, P.O. Box 9106, Norwood, MA 02062-9106 Phone: 781-329-4700 • Order online at [www.analog.com](http://www.analog.com) Application Support: Phone: 1-800-ANALOG-D



**Input IP3 vs.  
Temperature @ LO = +2 dBm**

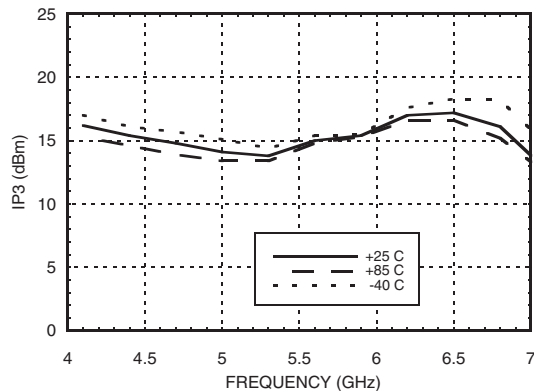

**Input IP3 vs. LO Drive**

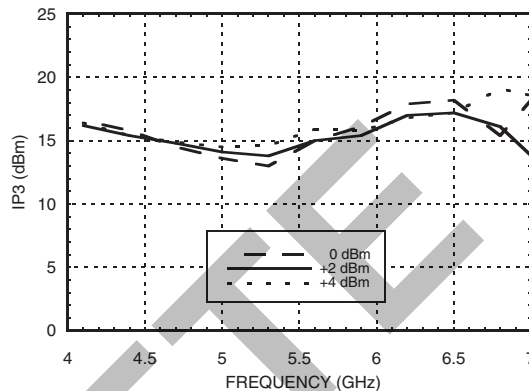

**Input IP2 vs.  
Temperature @ LO = +2 dBm**

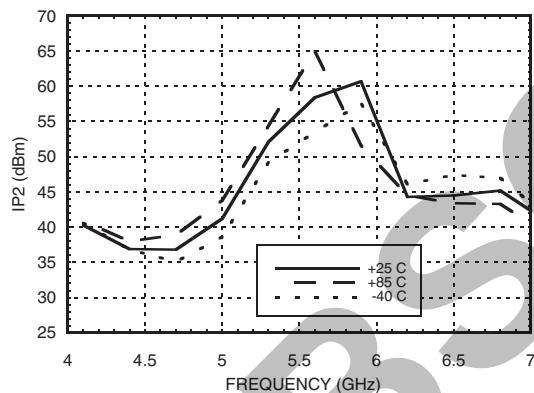

**Input IP2 vs. LO Drive**

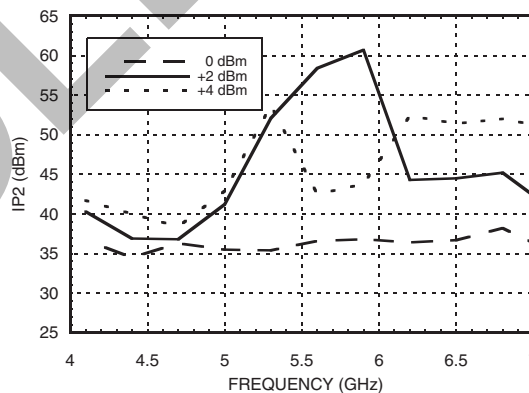

**Input P1dB vs.  
Temperature @ LO = +2 dBm**

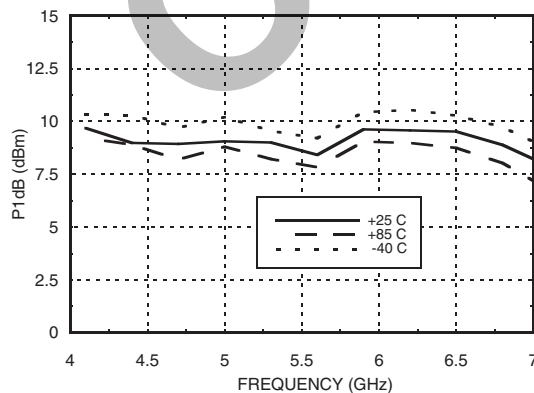

**Input P1dB vs. LO Drive**

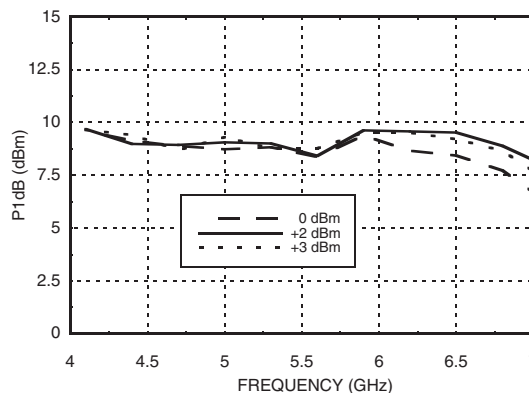

Information furnished by Analog Devices is believed to be accurate and reliable. However, no responsibility is assumed by Analog Devices for its use, nor for any infringements of patents or other rights of third parties that may result from its use. Specifications subject to change without notice. No license is granted by implication or otherwise under any patent or patent rights of Analog Devices. Trademarks and registered trademarks are the property of their respective owners.

For price, delivery, and to place orders: Analog Devices, Inc., One Technology Way, P.O. Box 9106, Norwood, MA 02062-9106 Phone: 781-329-4700 • Order online at [www.analog.com](http://www.analog.com) Application Support: Phone: 1-800-ANALOG-D



### MxN Spurious @ IF Port

mRF	nLO				
	0	1	2	3	4
0	xx	9	20	24	40
1	12	0	29	52	41
2	62	60	63	60	77
3	77	83	74	63	75
4	83	83	84	85	82

RF Freq. = 5.3 GHz @ -10 dBm  
 LO Freq. = 5.2 GHz @ +3 dBm  
 All values in dBc relative to the IF power level.

### Harmonics of LO

LO Freq. (GHz)	nLO Spur @ RF Port			
	1	2	3	4
5	32	18	42	52
5.2	32	19	62	56
5.4	31	23	52	59
5.6	31	26	43	64
5.8	31	26	40	57
6	31	27	43	51

LO = +3 dBm  
 All values in dBc below input LO level measured at RF port.

### Typical Supply Current vs. Vdd

Vdd	Idd (mA)
+4.75	45
+5.0	46
+5.25	47

Mixer will operate over full voltage range shown above.

OBSOLETE



**GaAs MMIC MIXER W/ INTEGRATED LO AMPLIFIER, 4 - 7 GHz**

**Absolute Maximum Ratings**

RF / IF Input (Vdd= +5V)	+13 dBm
LO Drive (Vdd= +5V)	+15 dBm
Vdd	+7 Vdc
Channel Temperature	150°C
Continuous P <sub>diss</sub> (T = 85°C) (derate 13.2 mW/°C above 85°C)	0.85 W
Thermal Resistance (channel to ground paddle)	75.5 °C/W
Storage Temperature	-65 to +150°C
Operating Temperature	-40 to +85°C
ESD Sensitivity (HBM)	Class 1A



**ELECTROSTATIC SENSITIVE DEVICE  
OBSERVE HANDLING PRECAUTIONS**

**Outline Drawing**

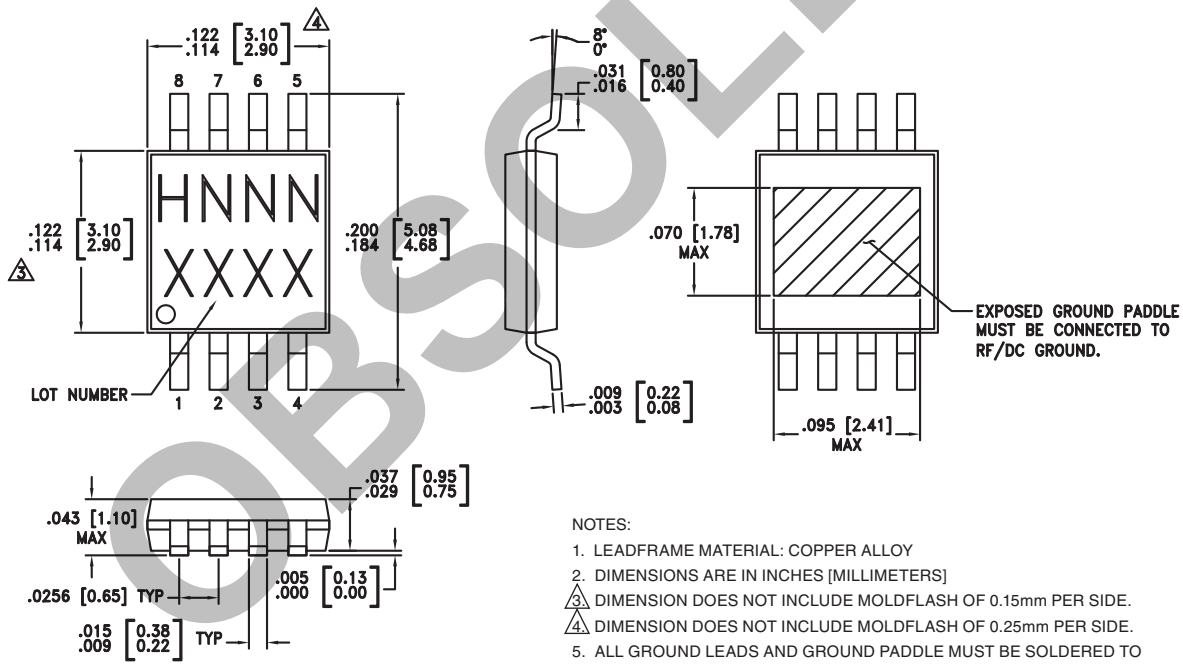

- NOTES:
1. LEADFRAME MATERIAL: COPPER ALLOY
  2. DIMENSIONS ARE IN INCHES [MILLIMETERS]
  - ③ DIMENSION DOES NOT INCLUDE MOLDFLASH OF 0.15mm PER SIDE.
  - ④ DIMENSION DOES NOT INCLUDE MOLDFLASH OF 0.25mm PER SIDE.
  5. ALL GROUND LEADS AND GROUND PADDLE MUST BE SOLDERED TO PCB RF GROUND.

**Package Information**

Part Number	Package Body Material	Lead Finish	MSL Rating	Package Marking <sup>[3]</sup>
HMC488MS8G	Low Stress Injection Molded Plastic	Sn/Pb Solder	MSL1 <sup>[1]</sup>	H488 XXXX
HMC488MS8GE	RoHS-compliant Low Stress Injection Molded Plastic	100% matte Sn	MSL1 <sup>[2]</sup>	<u>H488</u> XXXX



[1] Max peak reflow temperature of 235 °C  
 [2] Max peak reflow temperature of 260 °C  
 [3] 4-Digit lot number XXXX

Information furnished by Analog Devices is believed to be accurate and reliable. However, no responsibility is assumed by Analog Devices for its use, nor for any infringements of patents or other rights of third parties that may result from its use. Specifications subject to change without notice. No license is granted by implication or otherwise under any patent or patent rights of Analog Devices. Trademarks and registered trademarks are the property of their respective owners.

For price, delivery, and to place orders: Analog Devices, Inc., One Technology Way, P.O. Box 9106, Norwood, MA 02062-9106 Phone: 781-329-4700 • Order online at [www.analog.com](http://www.analog.com) Application Support: Phone: 1-800-ANALOG-D

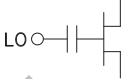

### Pin Descriptions

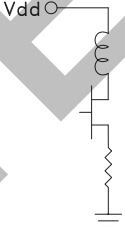
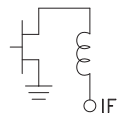
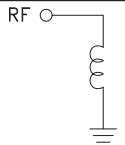
Pin Number	Function	Description	Interface Schematic
1	LO	This pin is AC coupled and matched to 50 Ohms.	
2, 6, 7	GND	This pin must be connected to RF ground.	
3, 4	Vdd	These pins are power supply for LO amp. An external RF bypass capacitor (10,000 pF) is required.	
5	IF	This pin is DC coupled. For applications not requiring operation to DC this port should be DC blocked externally using a series capacitor. Choose value of capacitor to pass IF frequency desired. For operation to DC, this pin must not sink/source more than 40 mA of current or failure may result.	
8	RF	This pin is DC coupled and matched to 50 Ohms.	

OBSOLETE

**HMC488MS8G / 488MS8GE**

**GaAs MMIC MIXER W/ INTEGRATED  
LO AMPLIFIER, 4 - 7 GHz**

**Evaluation PCB**

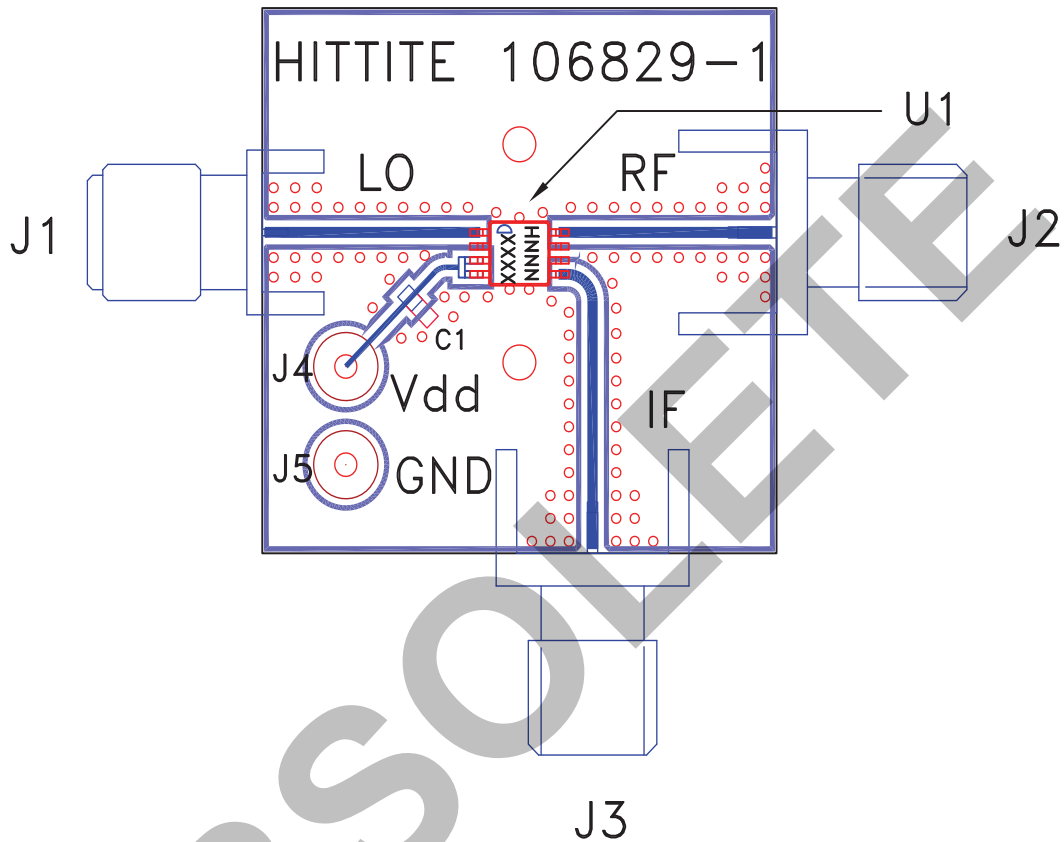

**List of Materials for Evaluation PCB 108190 [1]**

Item	Description
J1 - J3	PCB Mount SMA RF Connector
J4 - J5	DC Pins
C1	10,000 pF Chip Capacitor, 0603 Pkg.
U1	HMC488MS8G / HMC488MS8GE
PCB [2]	106829 Evaluation Board, 1.000" x 1.000"

[1] Reference this number when ordering complete evaluation PCB

[2] Circuit Board Material: Rogers 4350

The circuit board used in the final application should use RF circuit design techniques. Signal lines should have 50 ohm impedance while the package ground leads and exposed paddle should be connected directly to the ground plane similar to that shown. A sufficient number of via holes should be used to connect the top and bottom ground planes. The evaluation circuit board shown is available from Hittite upon request.





v03.0608

**HMC488MS8G / 488MS8GE****GaAs MMIC MIXER W/ INTEGRATED  
LO AMPLIFIER, 4 - 7 GHz****Notes:****OBSOLETE**