



Chipsmall Limited consists of a professional team with an average of over 10 year of expertise in the distribution of electronic components. Based in Hongkong, we have already established firm and mutual-benefit business relationships with customers from,Europe,America and south Asia,supplying obsolete and hard-to-find components to meet their specific needs.

With the principle of “Quality Parts,Customers Priority,Honest Operation,and Considerate Service”,our business mainly focus on the distribution of electronic components. Line cards we deal with include Microchip,ALPS,ROHM,Xilinx,Pulse,ON,Everlight and Freescale. Main products comprise IC,Modules,Potentiometer,IC Socket,Relay,Connector.Our parts cover such applications as commercial,industrial, and automotives areas.

We are looking forward to setting up business relationship with you and hope to provide you with the best service and solution. Let us make a better world for our industry!



Contact us

Tel: +86-755-8981 8866 Fax: +86-755-8427 6832

Email & Skype: info@chipsmall.com Web: www.chipsmall.com

Address: A1208, Overseas Decoration Building, #122 Zhenhua RD., Futian, Shenzhen, China



FEATURES

- Radio frequency (RF) range: 6 GHz to 10 GHz**
- Local oscillator (LO) input frequency range: 6 GHz to 10 GHz**
- Conversion loss: 8 dB typical at 6 GHz to 10 GHz**
- Image rejection: 23 dBc typical at 6 GHz to 10 GHz**
- LO to RF isolation: 43 dB typical**
- LO to intermediate frequency (IF) isolation: 25 dB typical**
- Input third-order intercept (IP3): 19 dBm typical**
- Input power for 1 dB compression (P1dB): 10 dBm typical at 7.1 GHz to 8.5 GHz**
- Wide IF frequency range: DC to 3.5 GHz**
- 24-terminal, 4 mm × 4 mm, ceramic leadless chip carrier**

APPLICATIONS

- Point to point microwave radios**
- Point to multipoint radios**
- Video satellites (VSATs)**
- Digital radios**
- Instrumentation**
- Automatic test equipment (ATE)**

GENERAL DESCRIPTION

The **HMC520A** is a compact gallium arsenide (GaAs), monolithic microwave integrated circuit (MMIC), in-phase quadrature (I/Q) mixer in a 24-terminal, RoHS compliant, ceramic leadless chip carrier (LCC) package. The device can be used as either an image reject mixer or a single sideband upconverter. The mixer uses two standard double balanced

FUNCTIONAL BLOCK DIAGRAM

Figure 1.

mixer cells and a 90° hybrid fabricated in a GaAs, metal semiconductor field effect transistor (MESFET) process. The **HMC520A** is a much smaller alternative to a hybrid style image reject mixer and a single sideband upconverter assembly. The **HMC520A** eliminates the need for wire bonding, allowing the use of surface-mount manufacturing techniques.

HMC520A* PRODUCT PAGE QUICK LINKS

Last Content Update: 02/23/2017

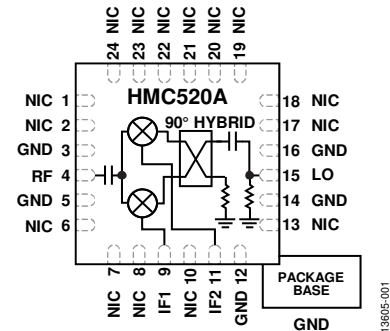
COMPARABLE PARTS

View a parametric search of comparable parts.

EVALUATION KITS

- HMC520A Evaluation Board

DOCUMENTATION

Data Sheet

- HMC520A: 6 GHz to 10 GHz, GaAs, MMIC, I/Q Mixer Data Sheet

DESIGN RESOURCES

- HMC520A Material Declaration
- PCN-PDN Information
- Quality And Reliability
- Symbols and Footprints

DISCUSSIONS

View all HMC520A EngineerZone Discussions.

SAMPLE AND BUY

Visit the product page to see pricing options.

TECHNICAL SUPPORT

Submit a technical question or find your regional support number.

DOCUMENT FEEDBACK

Submit feedback for this data sheet.

TABLE OF CONTENTS

Features	1	Downconverter Performance: IF = 3500 MHz, Lower Sideband (High-Side LO).....	14
Applications.....	1	Downconverter Performance: IF = 3500 MHz, Upper Sideband (Low-Side LO).....	16
Functional Block Diagram	1	Upconverter Performance: IF _{IN} = 100 MHz, Lower Sideband (High-Side LO).....	18
General Description	1	Amplitude/Phase Balance Downconverter: IF = 100 MHz, Lower Sideband (High-Side LO).....	19
Revision History	2	Amplitude/Phase Balance Downconverter: IF = 1500 MHz, Lower Sideband (High-Side LO).....	20
Specifications.....	3	Amplitude/Phase Balance Downconverter: IF = 3500 MHz, Lower Sideband (High-Side LO).....	21
Absolute Maximum Ratings.....	4	IF Bandwidth, Downconverter Performance	22
Thermal Resistance	4	Isolation and Return Loss	23
ESD Caution.....	4	Spurious and Harmonics Performance	24
Pin Configuration and Function Descriptions.....	5	Theory of Operation	25
Interface Schematics.....	5	Applications Information	26
Typical Performance Characteristics	6	Evaluation Board Information	27
Downconverter Performance: IF = 100 MHz, Lower Sideband (High-Side LO)	6	Outline Dimensions	28
Downconverter Performance: IF = 100 MHz, Upper Sideband (Low-Side LO)	8	Ordering Guide	28
Downconverter Performance: IF = 1500 MHz, Lower Sideband (High-Side LO).....	10		
Downconverter Performance: IF = 1500 MHz, Upper Sideband (Low-Side LO)	12		

REVISION HISTORY

1/2017—Revision 0: Initial Version

SPECIFICATIONS

LO = 15 dBm, IF = 100 MHz, RF = -10 dBm, T_A = 25°C, unless otherwise noted. All measurements were made as a downconverter with the lower sideband selected (high-side LO) and an external 90° IF hybrid at the IF ports, unless otherwise noted.

Table 1.

Parameter	Test Conditions/Comments	Min	Typ	Max	Unit
RF RANGE		6		10	GHz
LO INPUT FREQUENCY RANGE		6		10	GHz
IF FREQUENCY RANGE		DC		3.5	GHz
LO AMPLITUDE			15		dBm
6 GHz to 10 GHz PERFORMANCE					
Conversion Loss			8	10	dB
Noise Figure			8.5		dB
Input Third-Order Intercept (IP3)			19		dBm
Input Power for 1dB Compression (P1dB)			10.5		dBm
Image Rejection		19	23		dBc
LO to RF Isolation	Taken without external 90° IF hybrid	38	43		dB
LO to IF Isolation	Taken without external 90° IF hybrid		25		dB
Phase Balance	Taken without external 90° IF hybrid		5		Degree
Amplitude Balance	Taken without external 90° IF hybrid		0.3		dB
7.1 GHz to 8.5 GHz PERFORMANCE					
Conversion Loss			7.7	9.5	dB
Noise Figure			8		dB
Input Third-Order Intercept (IP3)			19		dBm
Input Power for 1dB Compression (P1dB)			10		dBm
Image Rejection		21	25		dBc
LO to RF Isolation	Taken without external 90° IF hybrid	38	43		dB
LO to IF Isolation	Taken without external 90° IF hybrid		25		dB
Phase Balance	Taken without external 90° IF hybrid		4		Degree
Amplitude Balance	Taken without external 90° IF hybrid		0.3		dB

ABSOLUTE MAXIMUM RATINGS

Table 2.

Parameter	Rating
RF Input Power	20 dBm
LO Input Power	27 dBm
IF1 and IF2 Input Power	20 dBm
IF DC Current	12 mA
Maximum Peak Reflow Temperature ¹	260°C
Continuous Power Dissipation, P _{DISS} (T _A = 85°C, Derate 4.44 mW/°C Above 85°C)	400 mW
Operating Temperature Range	-40°C to +85°C
Storage Temperature Range	-65°C to +150°C
Lead Temperature Range (Soldering 60 sec)	-65°C to +150°C
Electrostatic Discharge (ESD) Sensitivity	
Human Body Model (HBM)	750 V (Class 1B)
Field Induced Charged Device Model (FICDM)	1250 V (Class C3)

¹ See the Ordering Guide section.

Stresses at or above those listed under Absolute Maximum Ratings may cause permanent damage to the product. This is a stress rating only; functional operation of the product at these or any other conditions above those indicated in the operational section of this specification is not implied. Operation beyond the maximum operating conditions for extended periods may affect product reliability.

THERMAL RESISTANCE

Thermal performance is directly linked to printed circuit board (PCB) design and operating environment. Careful attention to PCB thermal design is required.

Table 3. Thermal Resistance

Package Type	θ_{JA}	θ_{JC} ¹	Unit
E-24-1 ²	175°C	225	°C/W

¹ θ_{JC} is the thermal resistance, junction to case (°C/W).

² See JEDEC standard JESD51-2 for additional information on optimizing the thermal impedance (PCB with 3 × 3 vias).

ESD CAUTION



ESD (electrostatic discharge) sensitive device. Charged devices and circuit boards can discharge without detection. Although this product features patented or proprietary protection circuitry, damage may occur on devices subjected to high energy ESD. Therefore, proper ESD precautions should be taken to avoid performance degradation or loss of functionality.

PIN CONFIGURATION AND FUNCTION DESCRIPTIONS

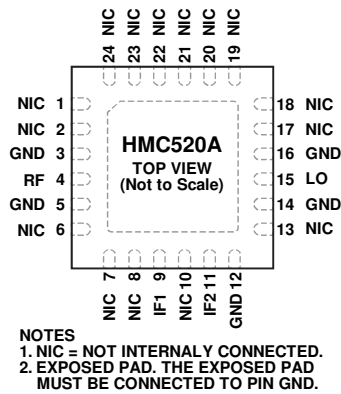

Figure 2. Pin Configuration

Table 4. Pin Function Descriptions

Pin No.	Mnemonic	Description
1, 2, 6 to 8, 10, 13, 17 to 24	NIC	Not Internally Connected.
3, 5, 12, 14, 16	GND	Ground. See Figure 7 for the GND interface schematic.
4	RF	RF Port. This pin is ac-coupled internally and matched to 50 Ω. See Figure 3 for the RF interface schematic.
9, 11	IF1, IF2	First and Second Quadrature Intermediate Frequency Input Pins. For applications that do not require operation to dc, use an off-chip dc blocking capacitor. For applications that require operation to dc, these pins must not source or sink more than 12 mA of current because the device may not function or possible device failure may result. See Figure 5 and Figure 6 for the IF1 and IF2 interface schematics.
15	LO	Local Oscillator Port. This pin is dc-coupled and matched to 50 Ω. See Figure 4 for the LO interface schematic.
	EPAD	Exposed Pad. The exposed pad must be connected to pin GND.

INTERFACE SCHEMATICS

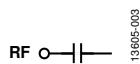

Figure 3. RF Interface Schematic

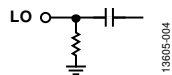

Figure 4. LO Interface Schematic

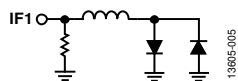

Figure 5. IF1 Interface Schematic

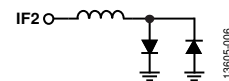

Figure 6. IF2 Interface Schematic



Figure 7. GND Interface Schematic

TYPICAL PERFORMANCE CHARACTERISTICS

DOWNCONVERTER PERFORMANCE: IF = 100 MHz, LOWER SIDEBAND (HIGH-SIDE LO)

Data taken as an image reject mixer with external 90° hybrid at the IF ports, LO = 15 dBm, unless otherwise noted.

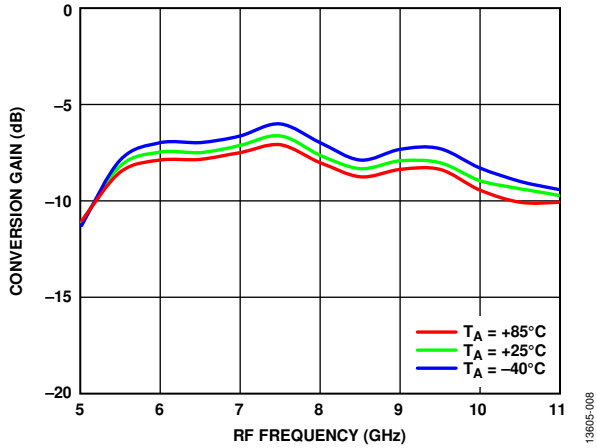

Figure 8. Conversion Gain vs. RF Frequency at Various Temperatures

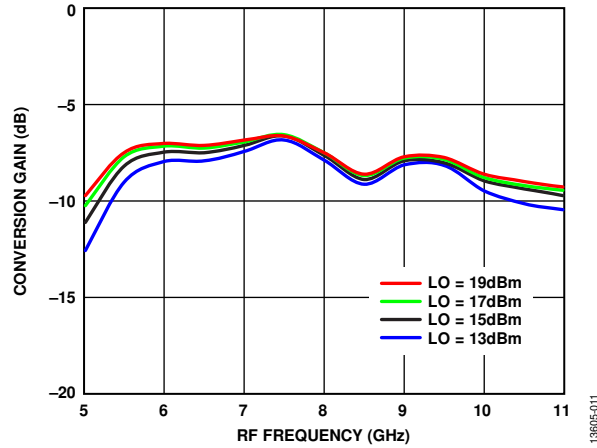

Figure 11. Conversion Gain vs. RF Frequency at Various LO Powers, $T_A = 25^\circ\text{C}$

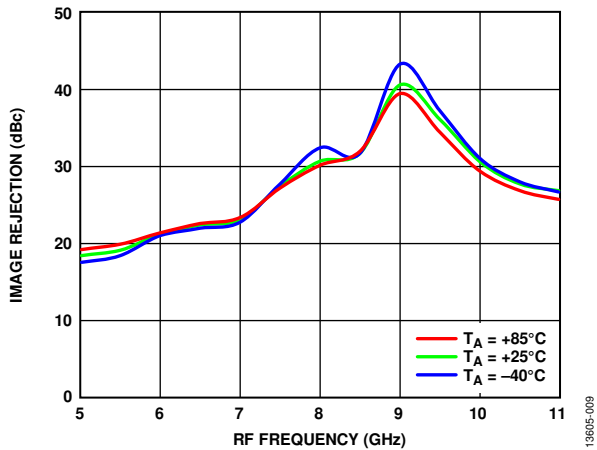

Figure 9. Image Rejection vs. RF Frequency at Various Temperatures

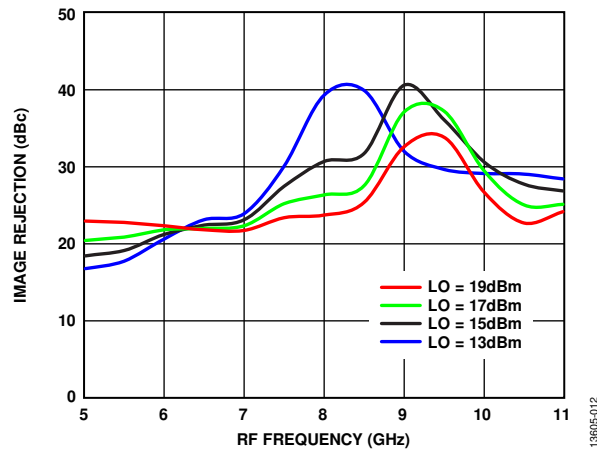

Figure 12. Image Rejection vs. RF Frequency at Various LO Powers, $T_A = 25^\circ\text{C}$

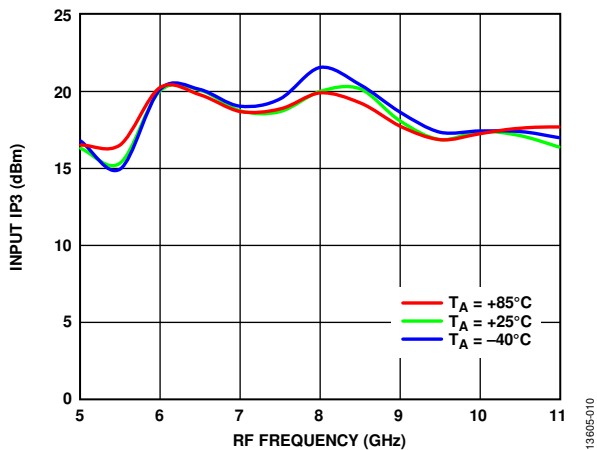

Figure 10. Input IP3 vs. RF Frequency at Various Temperatures

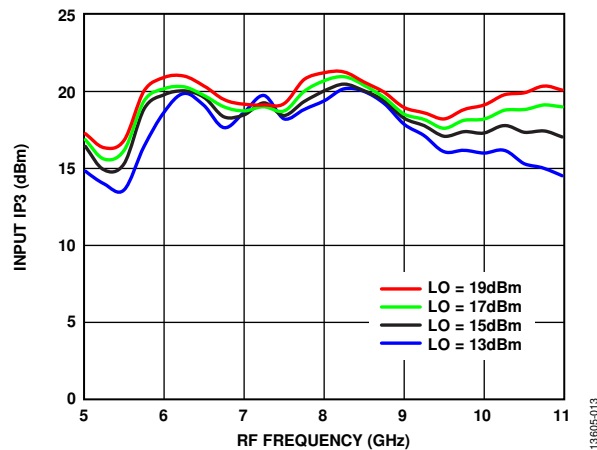

Figure 13. Input IP3 vs. RF Frequency at Various LO Powers, $T_A = 25^\circ\text{C}$

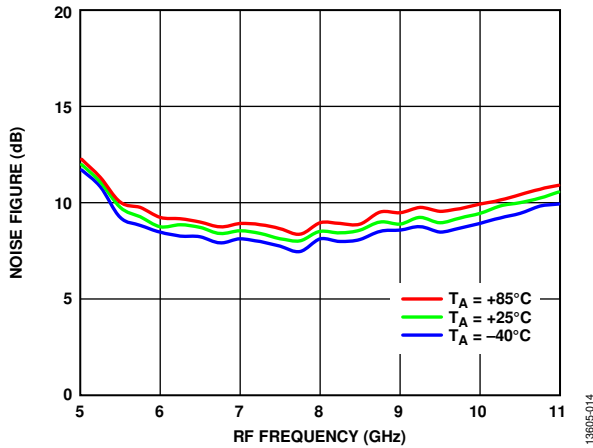

Figure 14. Noise Figure vs. RF Frequency at Various Temperatures

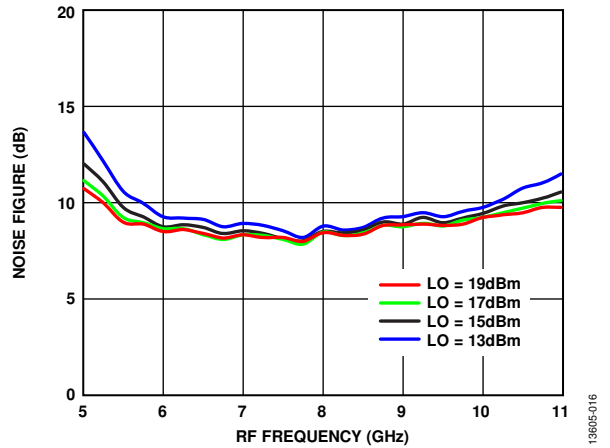

Figure 16. Noise Figure vs. RF Frequency at Various LO Powers, $T_A = 25^\circ\text{C}$

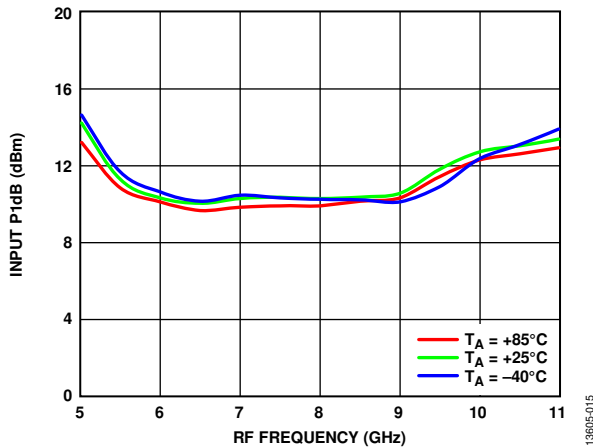

Figure 15. Input P1dB vs. RF Frequency at Various Temperatures

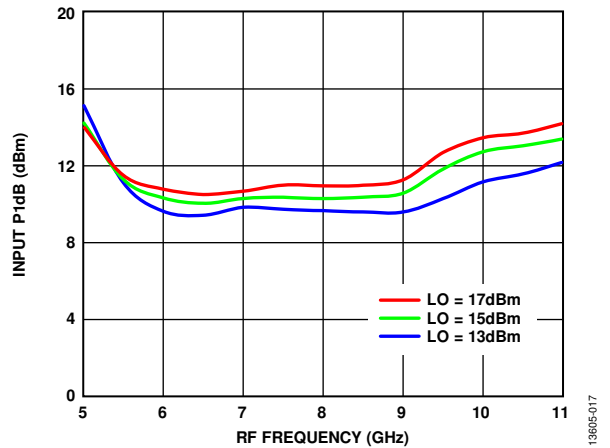

Figure 17. Input P1dB vs. RF Frequency at Various LO Powers, $T_A = 25^\circ\text{C}$

DOWNCONVERTER PERFORMANCE: IF = 100 MHz, UPPER SIDEBAND (LOW-SIDE LO)

Data taken as an image reject mixer with external 90° hybrid at the IF ports, LO = 15 dBm, unless otherwise noted.

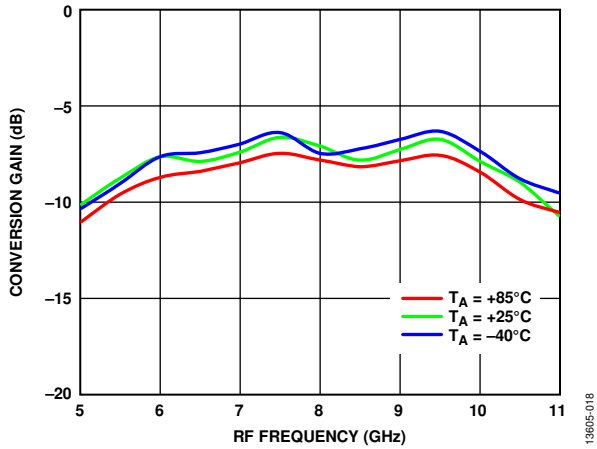

Figure 18. Conversion Gain vs. RF Frequency at Various Temperatures

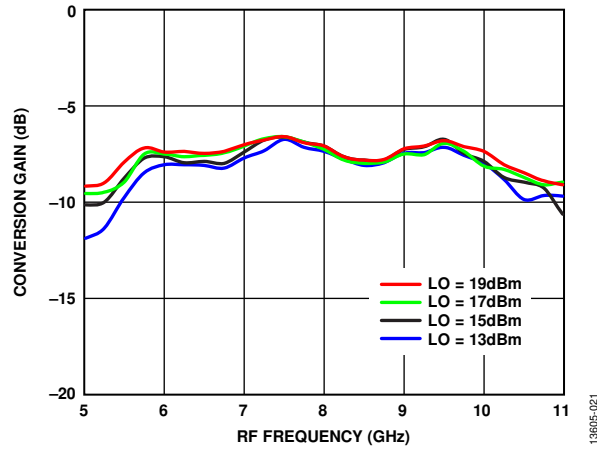

Figure 21. Conversion Gain vs. RF Frequency at Various LO Powers, $T_A = 25^\circ\text{C}$

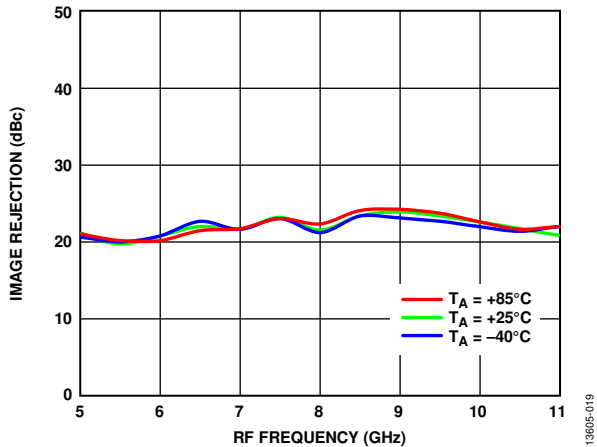

Figure 19. Image Rejection vs. RF Frequency at Various Temperatures

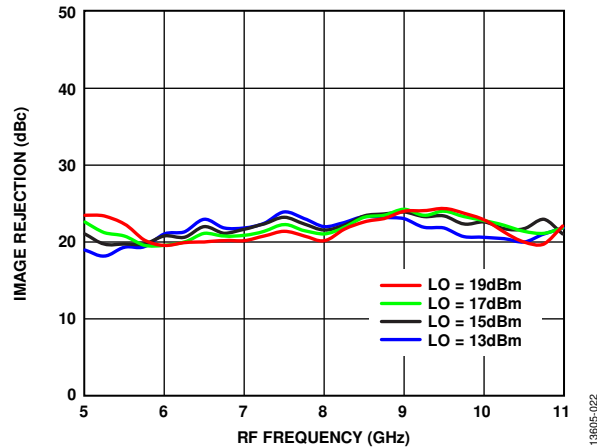

Figure 22. Image Rejection vs. RF Frequency at Various LO Powers, $T_A = 25^\circ\text{C}$

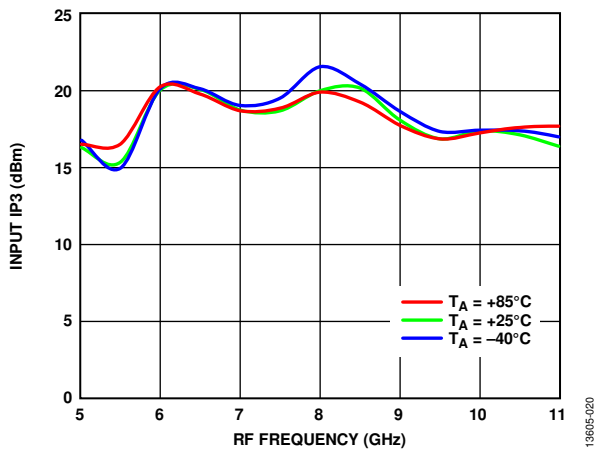

Figure 20. Input IP3 vs. RF Frequency at Various Temperatures

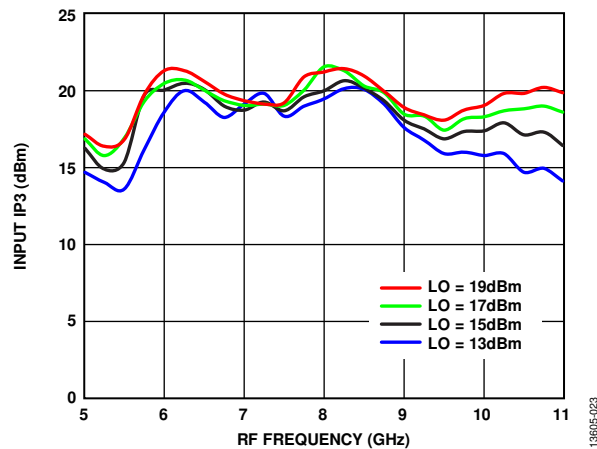

Figure 23. Input IP3 vs. RF Frequency at Various LO Powers, $T_A = 25^\circ\text{C}$

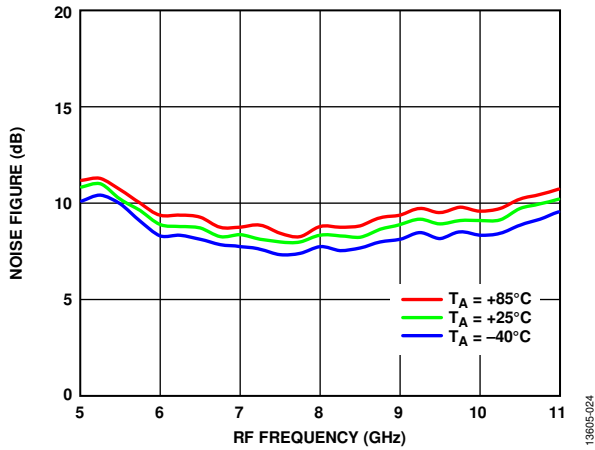

Figure 24. Noise Figure vs. RF Frequency at Various Temperatures

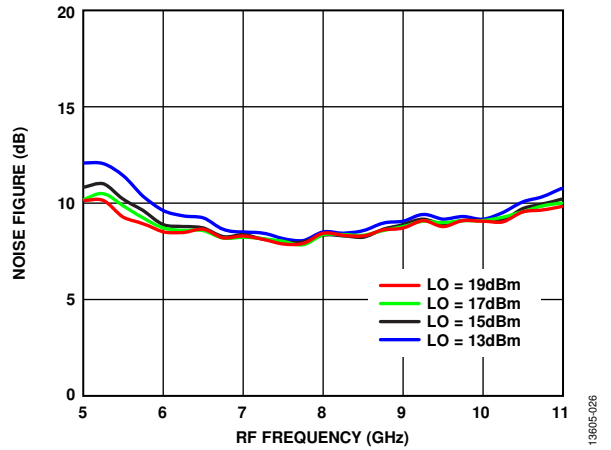

Figure 26. Noise Figure vs. RF Frequency at Various LO Powers, $T_A = 25^\circ\text{C}$

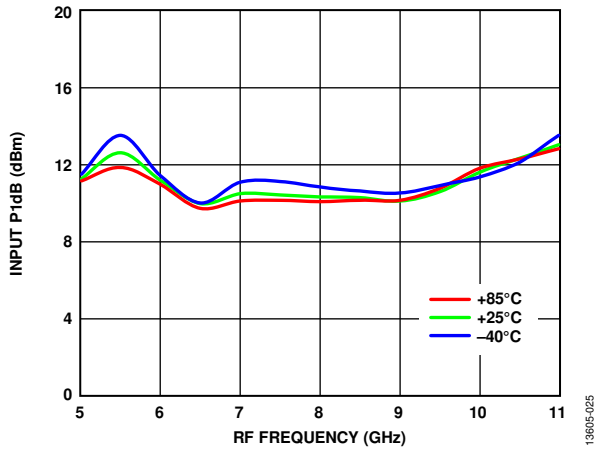

Figure 25. Input P1dB vs. RF Frequency at Various Temperatures

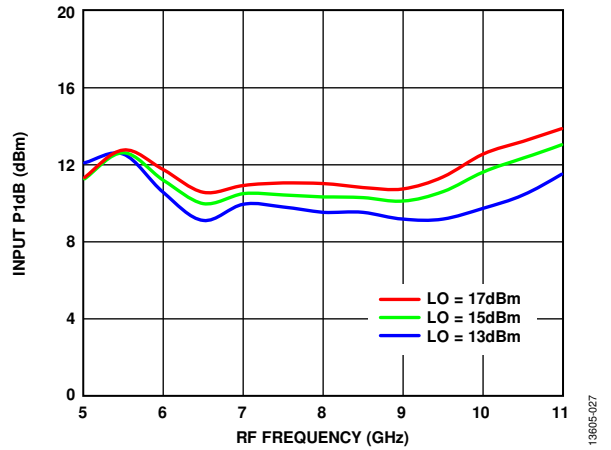

Figure 27. Input P1dB vs. RF Frequency at Various LO Powers, $T_A = 25^\circ\text{C}$

DOWNCONVERTER PERFORMANCE: IF = 1500 MHz, LOWER SIDEBAND (HIGH-SIDE LO)

Data taken as an image reject mixer with external 90° hybrid at the IF ports, LO = 15 dBm, unless otherwise noted.

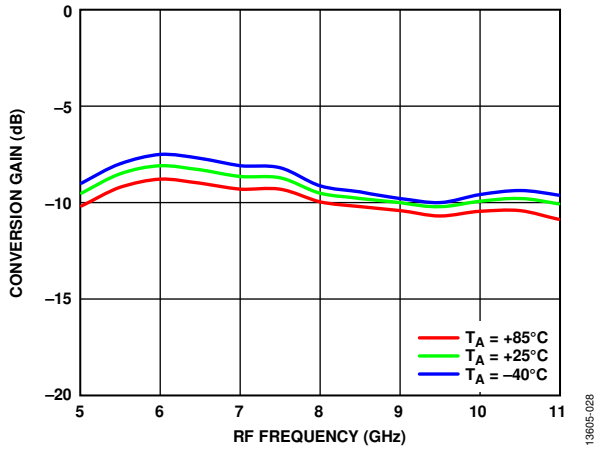

Figure 28. Conversion Gain vs. RF Frequency at Various Temperatures

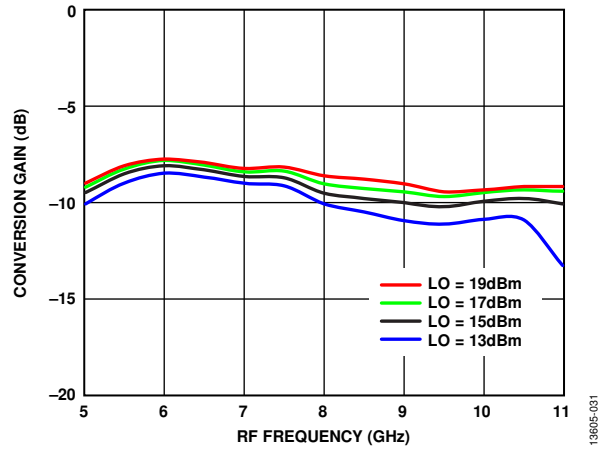

Figure 31. Conversion Gain vs. RF Frequency at Various LO Powers, $T_A = 25^\circ\text{C}$

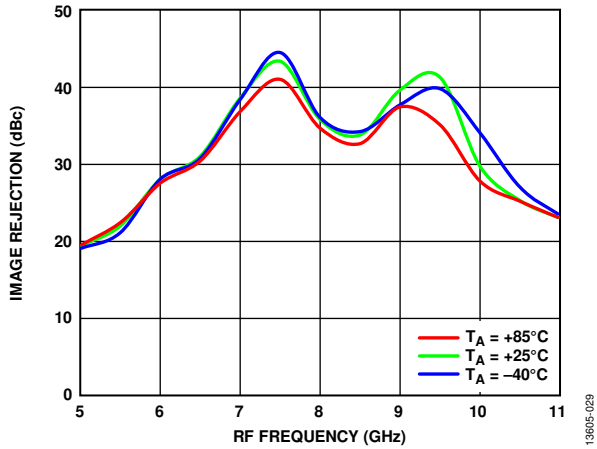

Figure 29. Image Rejection vs. RF Frequency at Various Temperatures

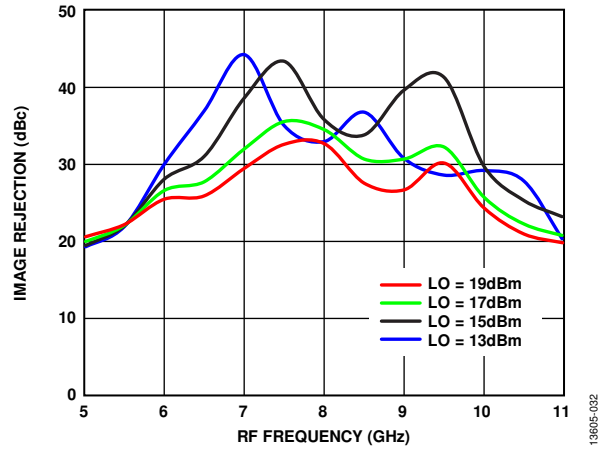

Figure 32. Image Rejection vs. RF Frequency at Various LO Powers, $T_A = 25^\circ\text{C}$

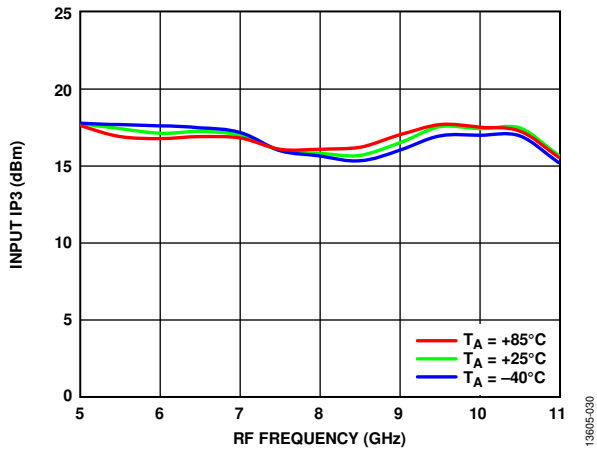

Figure 30. Input IP3 vs. RF Frequency at Various Temperatures

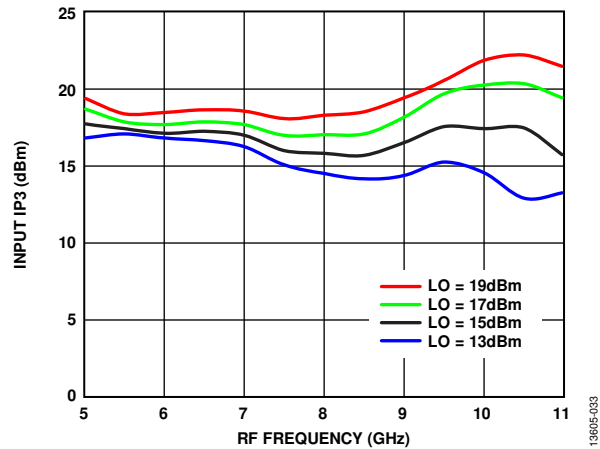

Figure 33. Input IP3 vs. RF Frequency at Various LO Powers, $T_A = 25^\circ\text{C}$

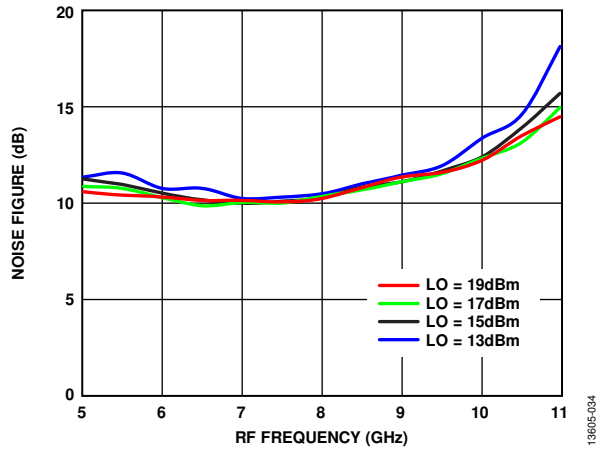

Figure 34. Noise Figure vs. RF Frequency at Various LO Powers, $T_A = 25^\circ\text{C}$

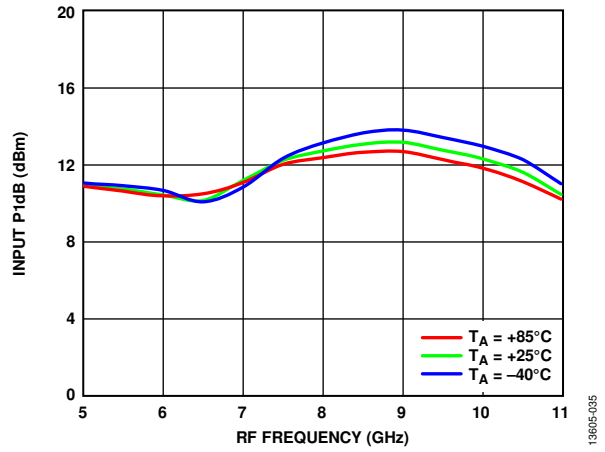

Figure 35. Input P1dB vs. RF Frequency at Various Temperatures

DOWNCONVERTER PERFORMANCE: IF = 1500 MHz, UPPER SIDEBAND (LOW-SIDE LO)

Data taken as an image reject mixer with external 90° hybrid at the IF ports, LO = 15 dBm, unless otherwise noted.

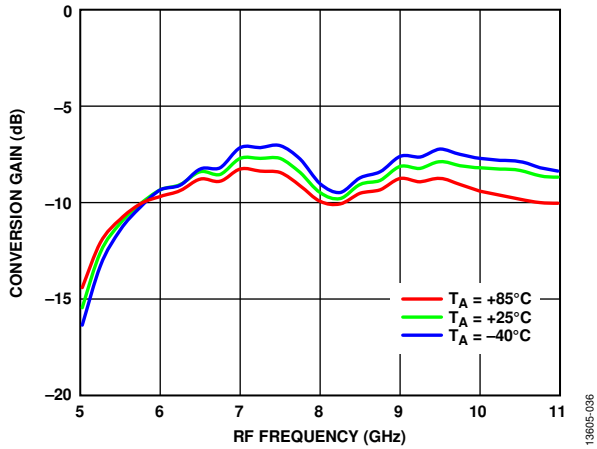

Figure 36. Conversion Gain vs. RF Frequency at Various Temperatures

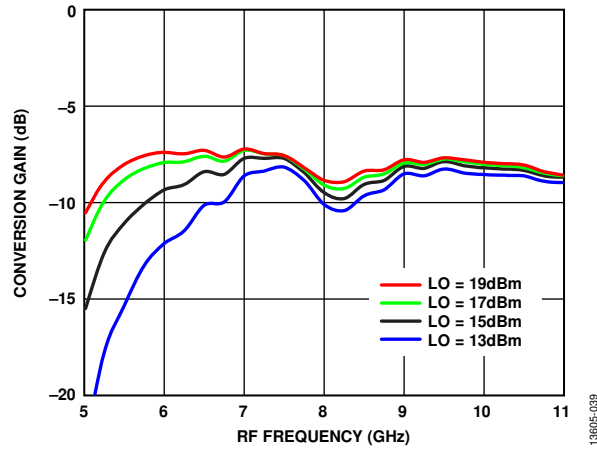

Figure 39. Conversion Gain vs. RF Frequency at Various LO Powers, $T_A = 25^\circ\text{C}$

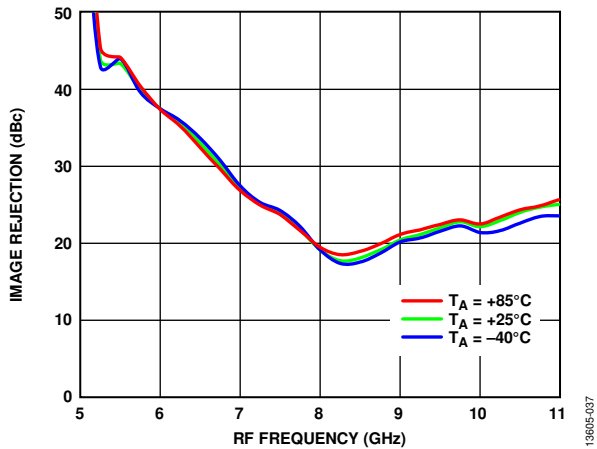

Figure 37. Image Rejection vs. RF Frequency at Various Temperatures

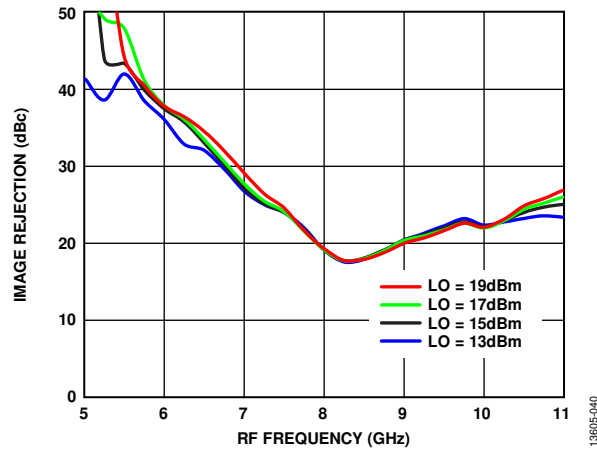

Figure 40. Image Rejection vs. RF Frequency at Various LO Powers

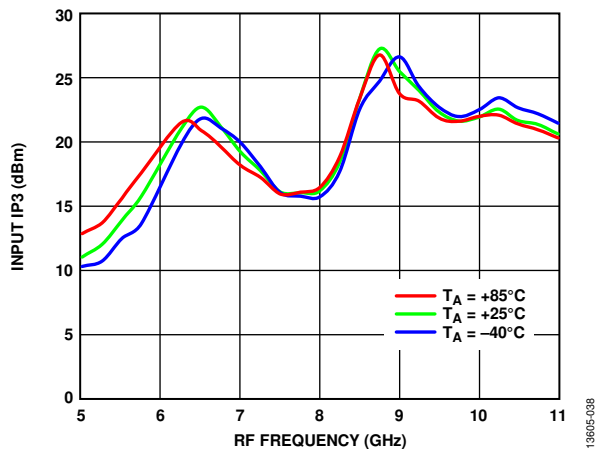

Figure 38. Input IP3 vs. RF Frequency at Various Temperatures

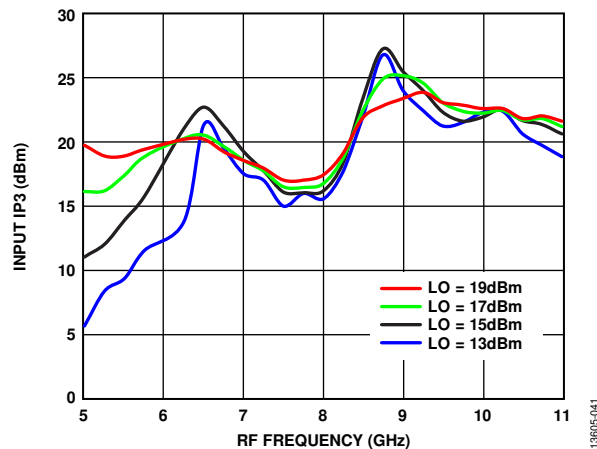

Figure 41. Input IP3 vs. RF Frequency at Various LO Powers, $T_A = 25^\circ\text{C}$

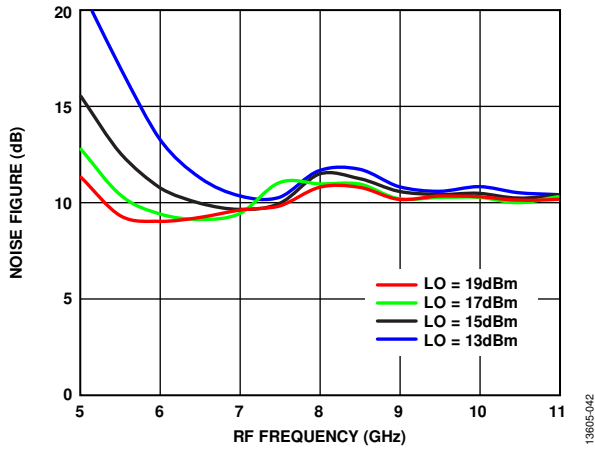

Figure 42. Noise Figure vs. RF Frequency at Various LO Powers, $T_A = 25^\circ\text{C}$

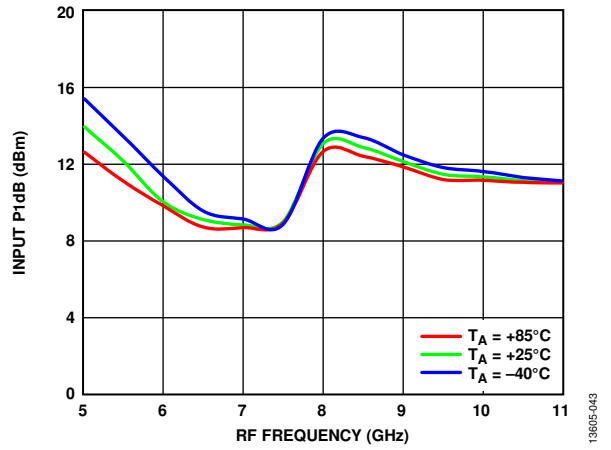

Figure 43. Input P1dB vs. RF Frequency at Various Temperatures

DOWNCONVERTER PERFORMANCE: IF = 3500 MHz, LOWER SIDEBAND (HIGH-SIDE LO)

Data taken as an image reject mixer with external 90° hybrid at the IF ports, LO = 15 dBm, unless otherwise noted.

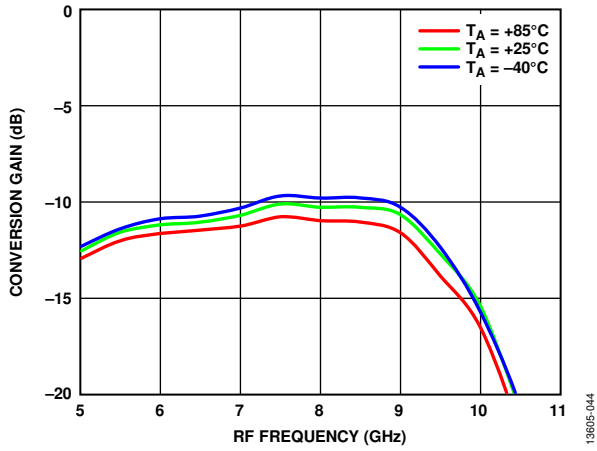

Figure 44. Conversion Gain vs. RF Frequency at Various Temperatures

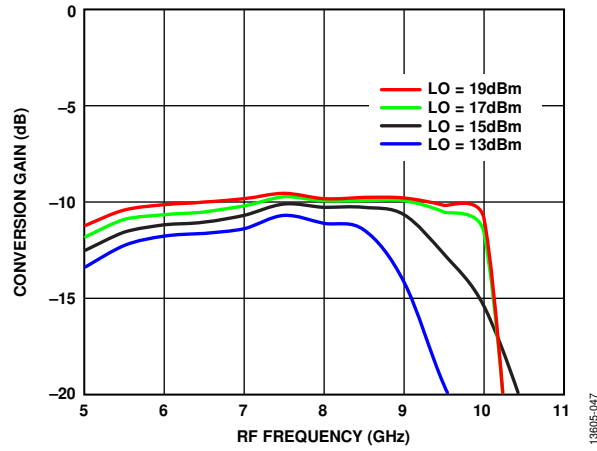

Figure 47. Conversion Gain vs. RF Frequency at Various LO Powers, $T_A = 25^\circ\text{C}$

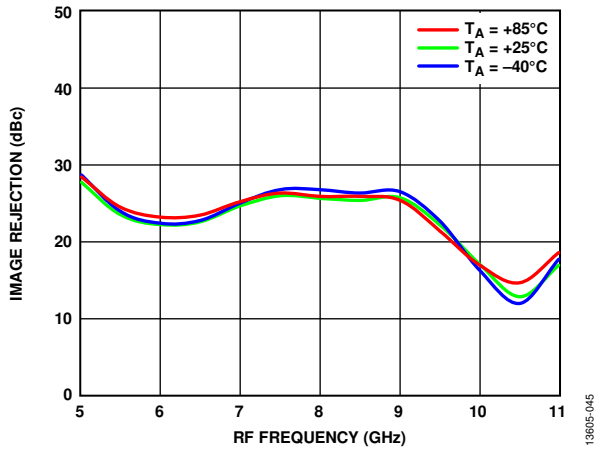

Figure 45. Image Rejection vs. RF Frequency at Various Temperatures

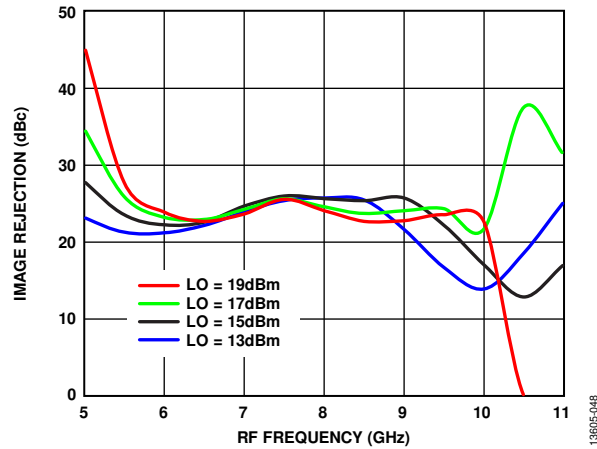

Figure 48. Image Rejection vs. RF Frequency at Various LO Powers, $T_A = 25^\circ\text{C}$

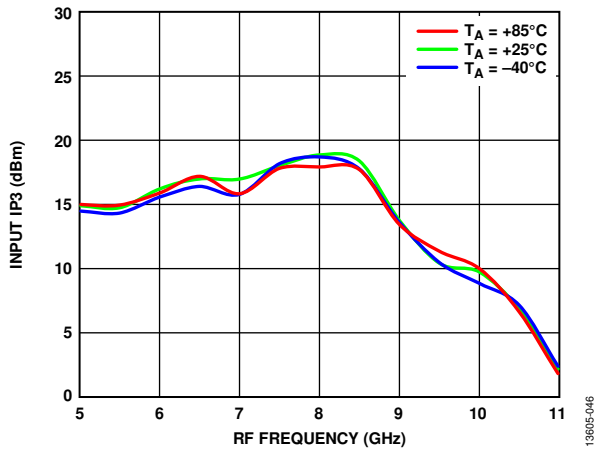

Figure 46. Input IP3 vs. RF Frequency at Various Temperatures

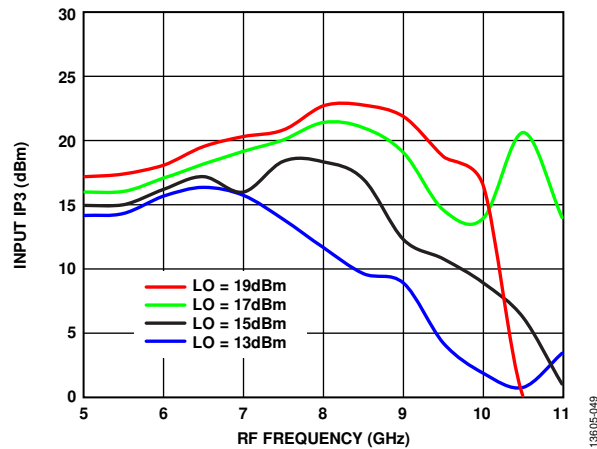

Figure 49. Input IP3 vs. RF Frequency at Various LO Powers, $T_A = 25^\circ\text{C}$

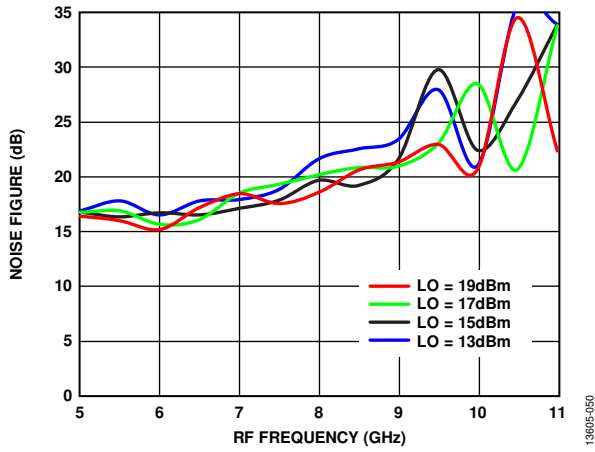

Figure 50. Noise Figure vs. RF Frequency at Various LO Powers, $T_A = 25^\circ\text{C}$

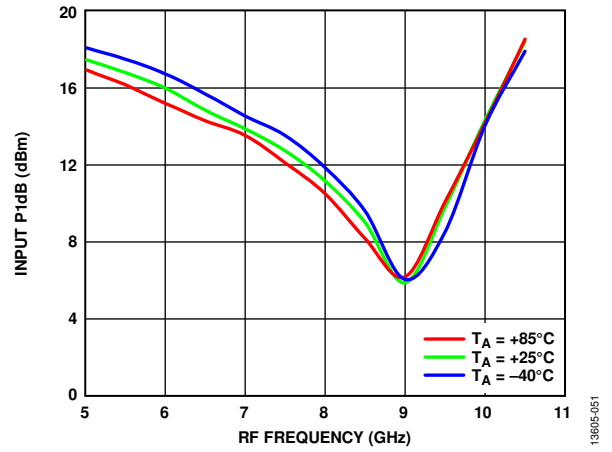

Figure 51. Input P1dB vs. RF Frequency at Various Temperatures

DOWNCONVERTER PERFORMANCE: IF = 3500 MHz, UPPER SIDEBAND (LOW-SIDE LO)

Data taken as an image reject mixer with external 90° hybrid at the IF ports, LO = 15 dBm, unless otherwise noted.

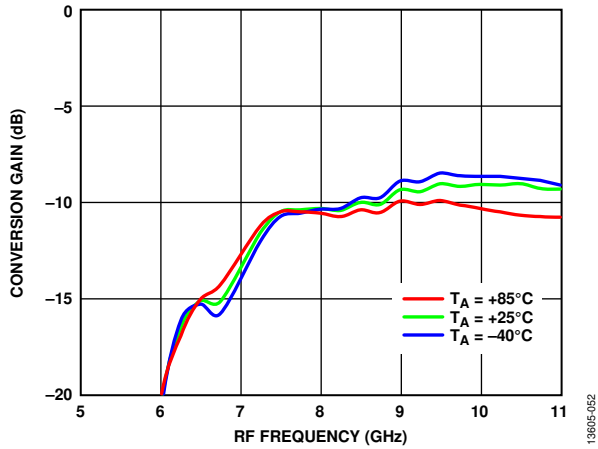

Figure 52. Conversion Gain vs. RF Frequency at Various Temperatures

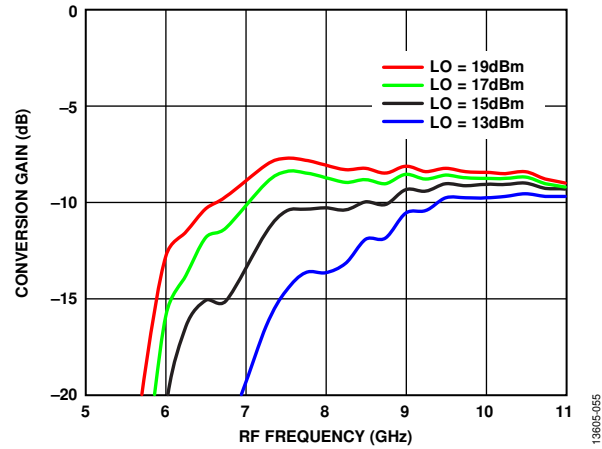

Figure 55. Conversion Gain vs. RF Frequency at Various LO Powers, $T_A = 25^\circ\text{C}$

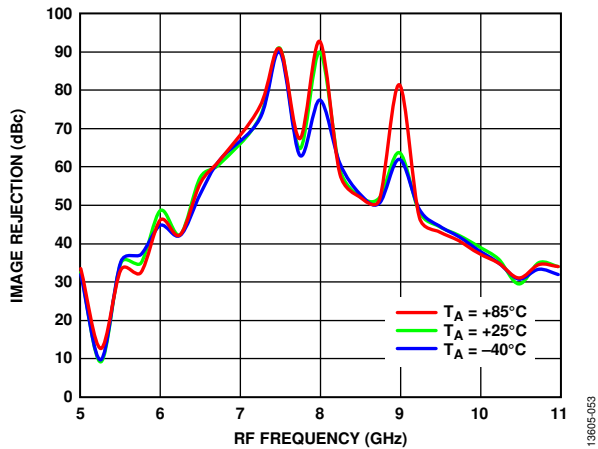

Figure 53. Image Rejection vs. RF Frequency at Various Temperatures

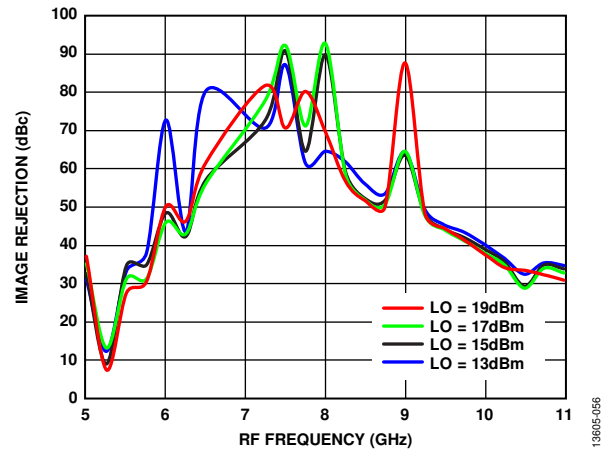

Figure 56. Image Rejection vs. RF Frequency at Various LO Powers

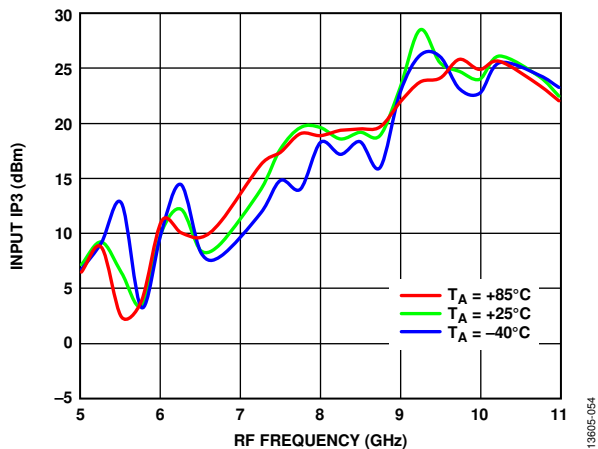

Figure 54. Input IP3 vs. RF Frequency at Various Temperatures

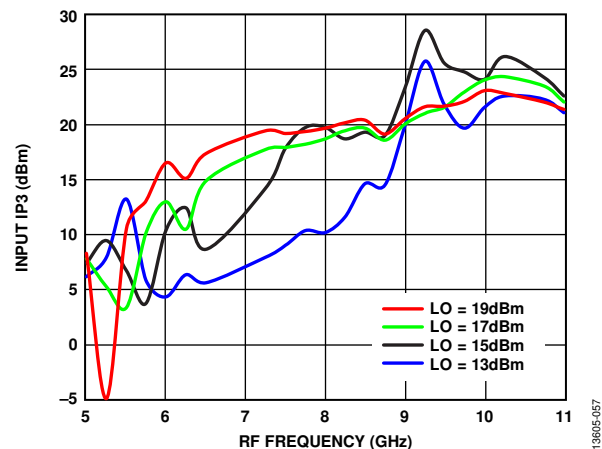

Figure 57. Input IP3 vs. RF Frequency at Various LO Powers, $T_A = 25^\circ\text{C}$

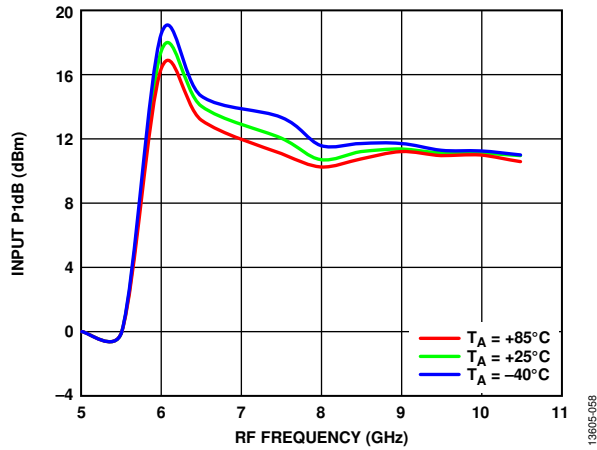

Figure 58. Input P1dB vs. RF Frequency at Various Temperatures

138805-058

UPCONVERTER PERFORMANCE: $IF_{IN} = 100 \text{ MHz}$, LOWER SIDEBAND (HIGH-SIDE LO)

Data taken as single sideband upconverter with external 90° hybrid at the IF ports, LO = 15 dBm, unless otherwise noted.

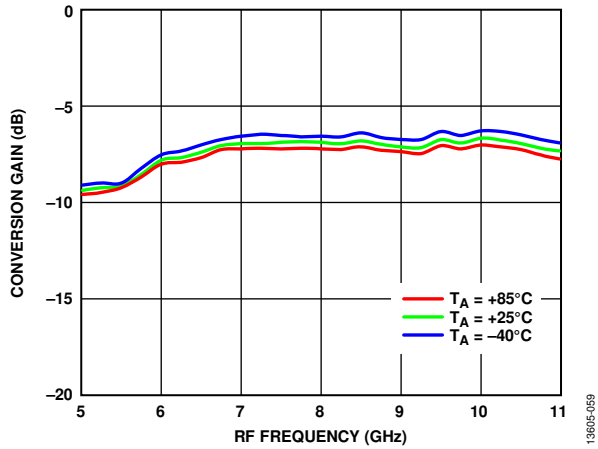

Figure 59. Conversion Gain vs. RF Frequency at Various Temperatures

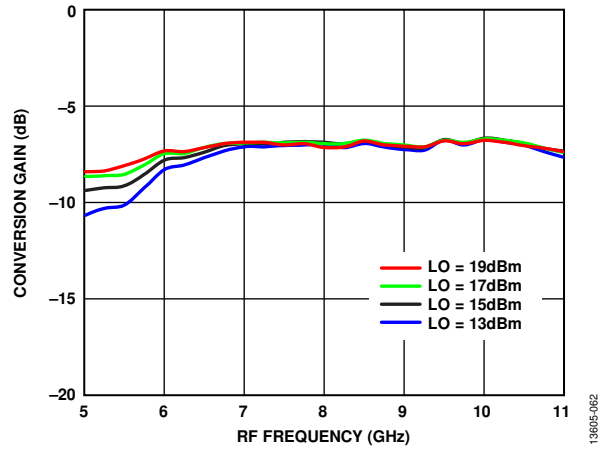

Figure 62. Conversion Gain vs. RF Frequency at Various LO Powers, $T_A = 25^\circ\text{C}$

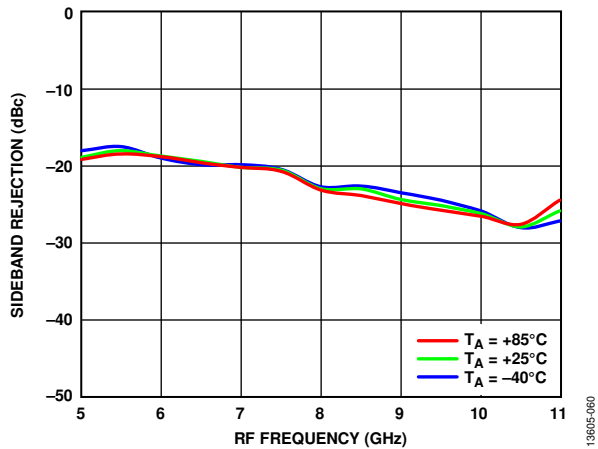

Figure 60. Sideband Rejection vs. RF Frequency at Various Temperatures

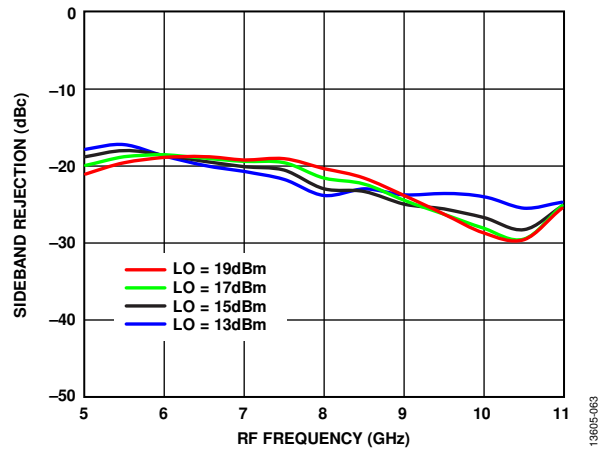

Figure 63. Sideband Rejection vs. RF Frequency at Various LO Powers, $T_A = 25^\circ\text{C}$

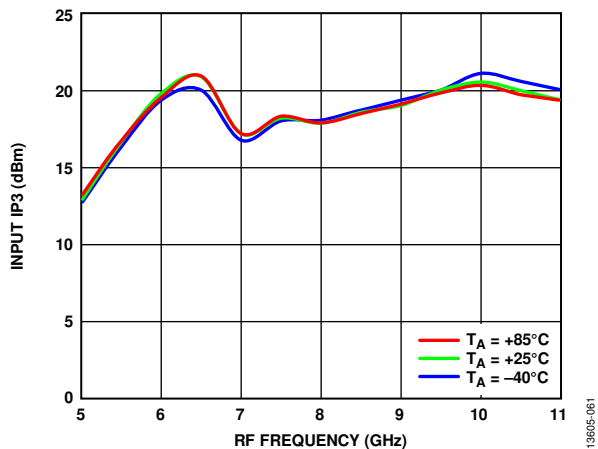

Figure 61. Input IP3 vs. RF Frequency at Various Temperature

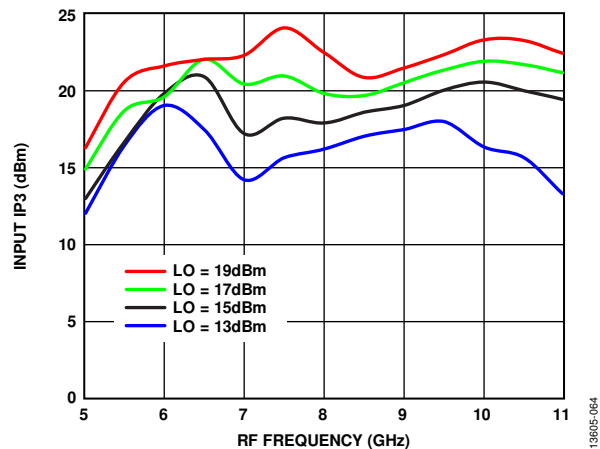

Figure 64. Input IP3 vs. RF Frequency at Various LO Powers, $T_A = 25^\circ\text{C}$

AMPLITUDE/PHASE BALANCE DOWNCONVERTER: IF = 100 MHz, LOWER SIDEBAND (HIGH-SIDE LO)

Data taken at LO = 15 dBm, unless otherwise noted.

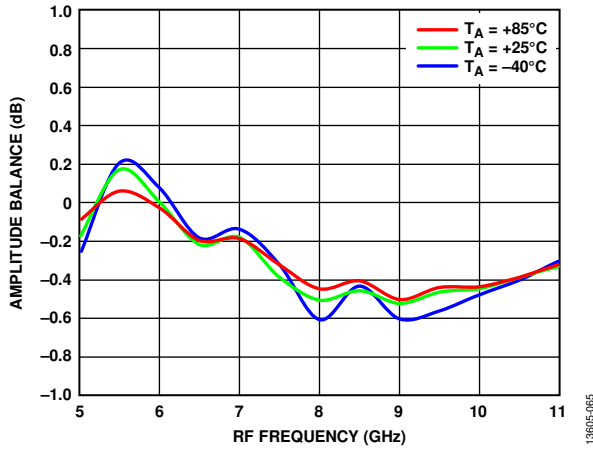

Figure 65. Amplitude Balance vs. RF Frequency at Various Temperatures

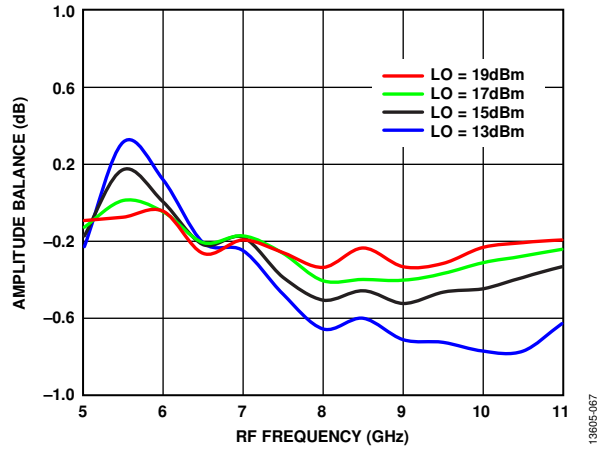

Figure 67. Amplitude Balance vs. RF Frequency at Various LO Powers, $T_A = 25^\circ\text{C}$

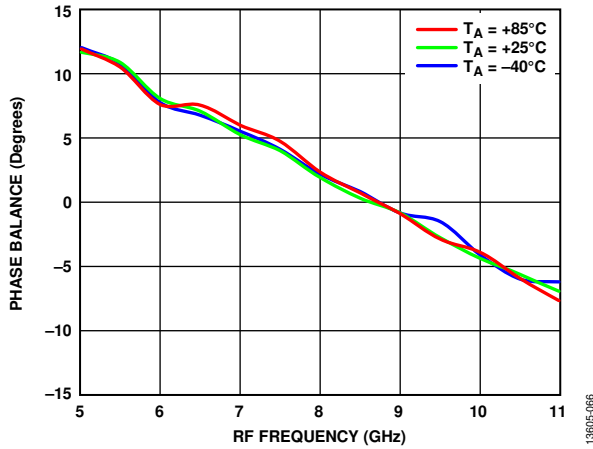

Figure 66. Phase Balance vs. RF Frequency at Various Temperatures

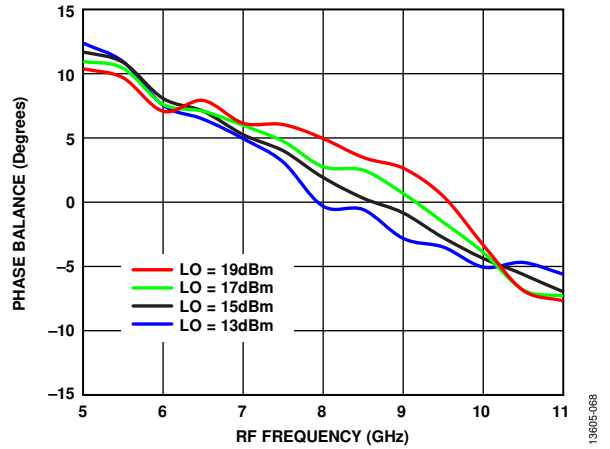

Figure 68. Phase Balance vs. RF Frequency at Various LO Powers, $T_A = 25^\circ\text{C}$

AMPLITUDE/PHASE BALANCE DOWNCONVERTER: IF = 1500 MHz, LOWER SIDEBAND (HIGH-SIDE LO)

Data taken at LO = 15 dBm, unless otherwise noted.

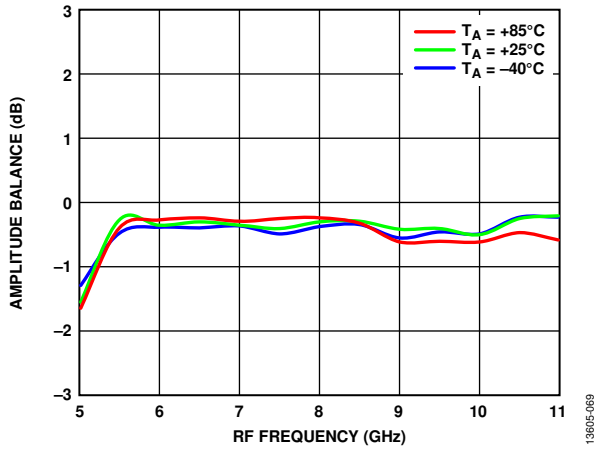

Figure 69. Amplitude Balance vs. RF Frequency at Various Temperatures

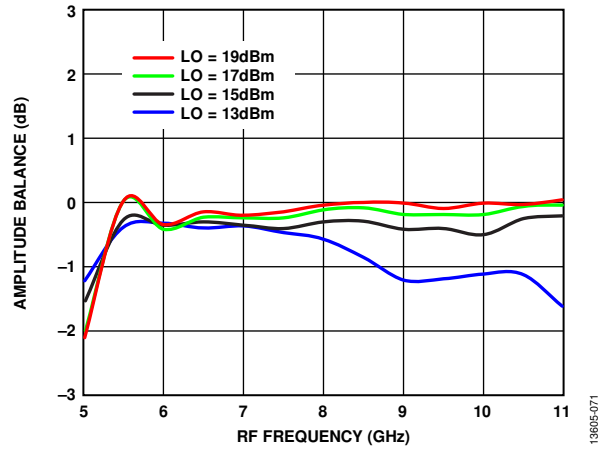

Figure 71. Amplitude Balance vs. RF Frequency at Various LO Powers, $T_A = 25^\circ\text{C}$

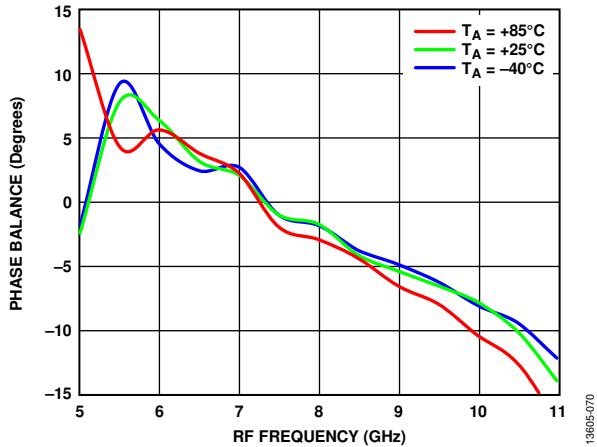

Figure 70. Phase Balance vs. RF Frequency at Various Temperatures

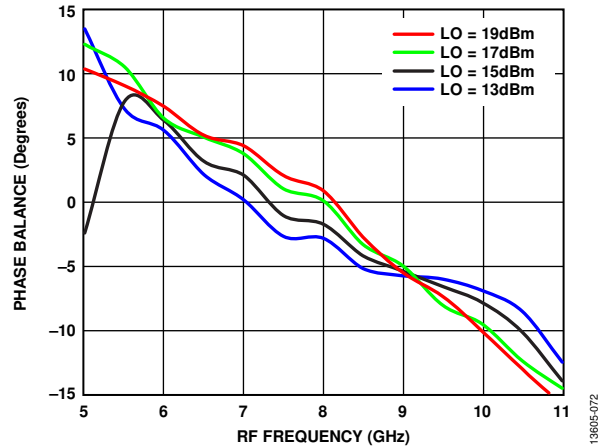

Figure 72. Phase Balance vs. RF Frequency at Various LO Powers, $T_A = 25^\circ\text{C}$

AMPLITUDE/PHASE BALANCE DOWNCONVERTER: IF = 3500 MHz, LOWER SIDEBAND (HIGH-SIDE LO)

Data taken at LO = 15 dBm, unless otherwise noted.

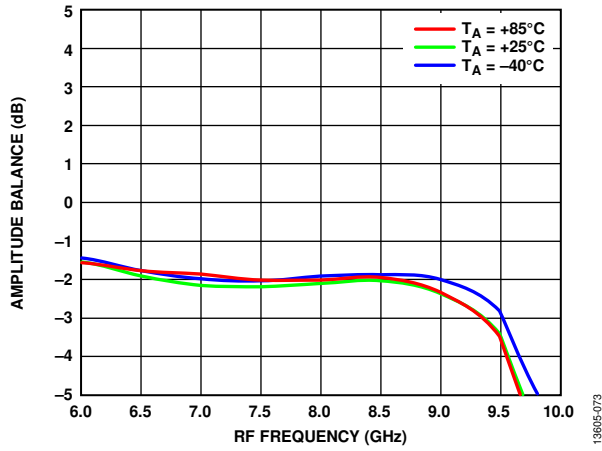

Figure 73. Amplitude Balance vs. RF Frequency at Various Temperatures

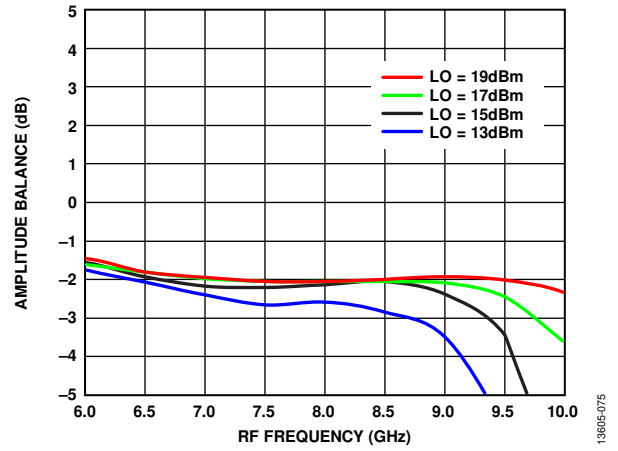

Figure 75. Amplitude Balance vs. RF Frequency at Various LO Powers, $T_A = 25^\circ\text{C}$

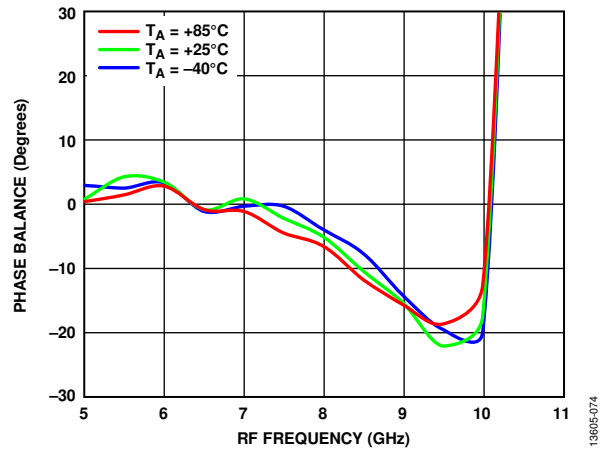

Figure 74. Phase Balance vs. RF Frequency at Various Temperatures

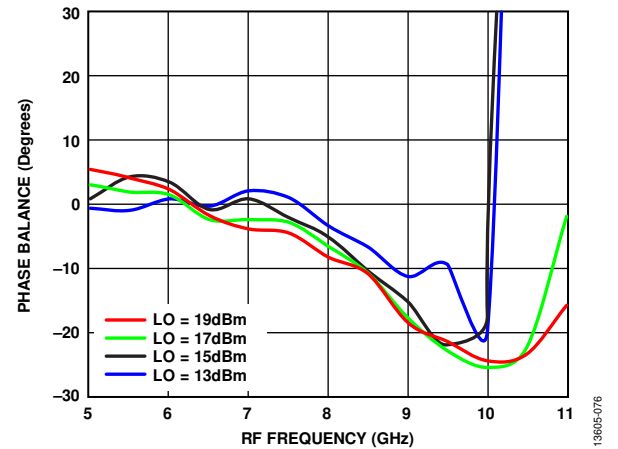

Figure 76. Phase Balance vs. RF Frequency at Various LO Powers, $T_A = 25^\circ\text{C}$

IF BANDWIDTH, DOWNCONVERTER PERFORMANCE

Data taken as an image reject mixer with an external 90° hybrid, and LO = 15 dBm, unless otherwise noted.

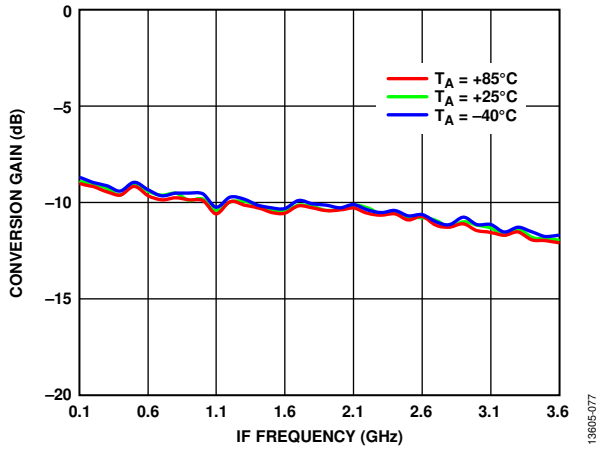

Figure 77. Conversion Gain vs. IF Frequency at Various Temperatures, Lower Sideband, LO = 10.5 GHz

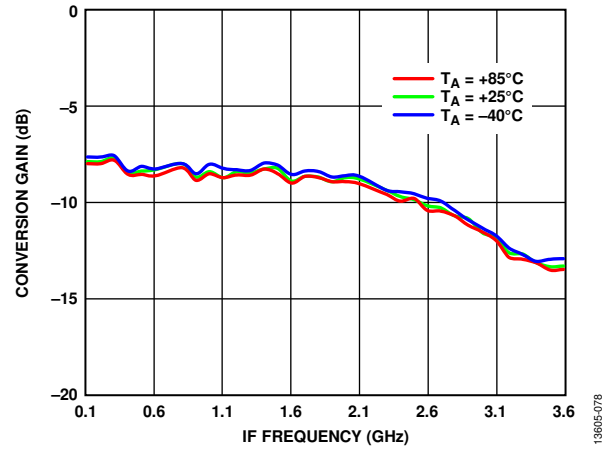

Figure 78. Conversion Gain vs. IF Frequency at Various Temperatures, Upper Sideband, LO = 8.5 GHz

ISOLATION AND RETURN LOSS

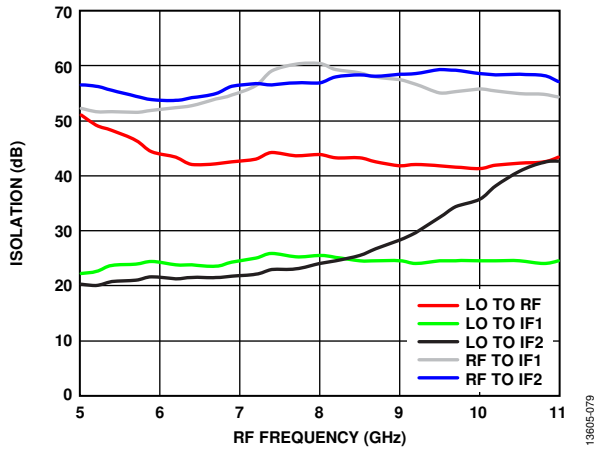

Figure 79. Isolation vs. RF Frequency at LO = 15 dBm, TA = 25°C

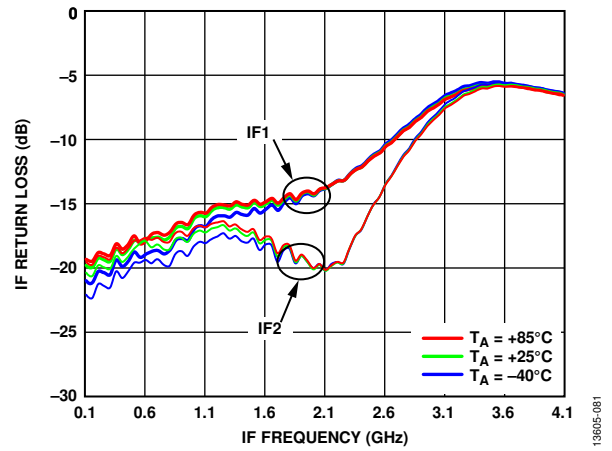

Figure 81. IF Return Loss vs. IF Frequency at Various Temperatures, LO = 8.5 GHz at 15 dBm

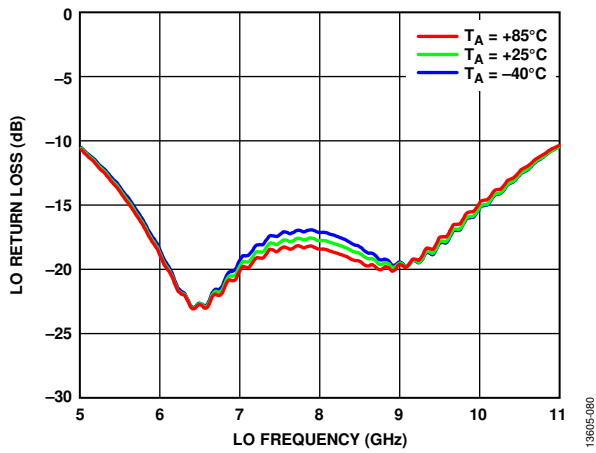

Figure 80. LO Return Loss vs. LO Frequency at Various Temperatures at LO = 15 dBm

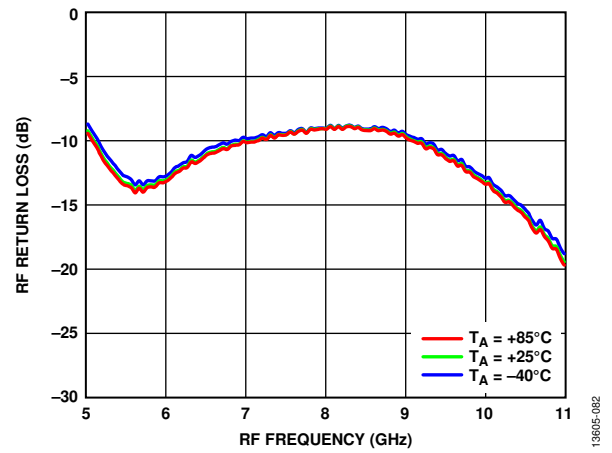

Figure 82. RF Return Loss vs. RF Frequency at Various Temperatures, LO = 8.5 GHz at 15 dBm

SPURIOUS AND HARMONICS PERFORMANCE

LO harmonic isolation, LO = 15 dBm, all values are in dBc below the input LO level at the RF port are positive, unless otherwise noted.

Table 5. N_{LO} Spur at RF Output (RF_{OUT})

LO Frequency (GHz)	N × LO			
	1	2	3	4
5.5	49	33	52	66
6.5	43	37	63	52
7	43	43	55	55
7.5	44	55	52	61
8.5	43	59	69	62
9.5	42	61	62	65
10.5	42	72	56	61

RF = 9400 MHz at -10 dBm, LO = 9500 MHz at 15 dBm, data taken without external hybrid, and all values are in dBc measured below the IF power level (M × RF) - (N × LO) are positive, unless otherwise noted.

Table 6. M × N Spurious Output Performance, Downconverter, Lower Sideband (High-Side LO), IF = 100 MHz, T_A = 25°C

		N × LO					
		0	1	2	3	4	5
M × RF	0	0	-13	+31	+12	+39	+56
	1	+31	0	+42	+60	+62	+50
	2	+71	+57	+66	+58	+70	+60
	3	+69	+70	+75	+67	+74	+71
	4	+62	+68	+71	+75	+85	+74
	5	+58	+61	+67	+71	+77	+85

RF = 7600 MHz at -10 dBm, LO = 7500 MHz at 15 dBm, data taken without external hybrid, and all values are in dBc measured below the IF power level (M × RF) - (N × LO) are positive, unless otherwise noted.

Table 7. M × N Spurious Output Performance, Downconverter, Upper Sideband (Low-Side LO), IF = 100 MHz, T_A = 25°C

		N × LO					
		0	1	2	3	4	5
M × RF	0	0	-10	+23	+29	+46	+35
	1	+31	0	+36	+49	+68	+53
	2	+73	+51	+76	+50	+75	+65
	3	+68	+74	+78	+72	+78	+73
	4	+68	+71	+71	+79	+87	+77
	5	+62	+68	+70	+73	+77	+86

RF_{OUT} = 7600 MHz, LO = 7500 MHz at 15 dBm, data taken without external hybrid, and all values are in dBc measured below the RF_{OUT} power level (M × IF_{IN}) - (N × LO) are positive, unless otherwise noted.

Table 8. M × N Spurious Output Performance, Upconverter, Upper Sideband (Low-Side LO), IF_{IN} = 100 MHz at -10 dBm, T_A = 25°C

		N × LO					
		0	1	2	3	4	5
M × IF	0	0	6	26	24	29	42
	1	78	0	24	30	56	42
	2	89	53	71	67	62	58
	3	88	65	73	67	64	60
	4	88	76	71	66	64	58
	5	86	77	72	68	63	59

RF_{OUT} = 9400 MHz, LO = 9500 MHz at 15 dBm, data taken without external hybrid, and all values are in dBc measured below the RF_{OUT} power level (M × IF_{IN}) - (N × LO) are positive, unless otherwise noted.

Table 9. M × N Spurious Output Performance, Upconverter, Lower Sideband (High-Side LO), IF_{IN} = 100 MHz at -10 dBm, T_A = 25°C

		N × LO					
		0	1	2	3	4	5
M × IF	0	0	8	21	17	26	35
	1	79	0	25	48	54	37
	2	87	55	47	57	56	59
	3	87	60	74	72	68	61
	4	86	77	73	72	66	61
	5	86	78	74	72	67	60