



Chipsmall Limited consists of a professional team with an average of over 10 year of expertise in the distribution of electronic components. Based in Hongkong, we have already established firm and mutual-benefit business relationships with customers from,Europe,America and south Asia,supplying obsolete and hard-to-find components to meet their specific needs.

With the principle of “Quality Parts,Customers Priority,Honest Operation,and Considerate Service”,our business mainly focus on the distribution of electronic components. Line cards we deal with include Microchip,ALPS,ROHM,Xilinx,Pulse,ON,Everlight and Freescale. Main products comprise IC,Modules,Potentiometer,IC Socket,Relay,Connector.Our parts cover such applications as commercial,industrial, and automotives areas.

We are looking forward to setting up business relationship with you and hope to provide you with the best service and solution. Let us make a better world for our industry!



## Contact us

Tel: +86-755-8981 8866 Fax: +86-755-8427 6832

Email & Skype: info@chipsmall.com Web: www.chipsmall.com

Address: A1208, Overseas Decoration Building, #122 Zhenhua RD., Futian, Shenzhen, China



## 1 dB LSB SILICON MMIC 4-BIT DIGITAL POSITIVE CONTROL ATTENUATOR, 0.1 - 8 GHz

### Typical Applications

The HMC540SLP3E is ideal for both RF and IF applications:

- Cellular Infrastructure
- Wireless Infrastructure
- Microwave Radio & VSAT
- Test Equipment and Sensors

### Functional Diagram

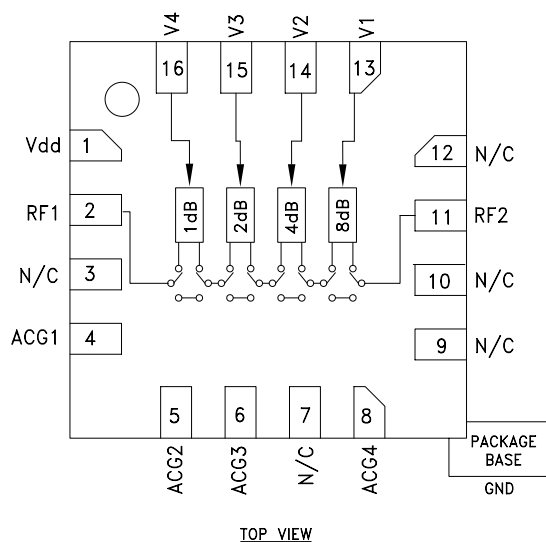

### Features

- 1 dB LSB Steps to 15 dB
- ± 0.2 dB Typical Step Error
- Low Insertion Loss: ≤ 1 dB
- High IP3: +56 dBm
- Single Control Line Per Bit
- TTL/CMOS Compatible Control
- Single +3.3/+5V Supply
- 3x3 mm SMT Package
- ESD rating: Class 2 (2kV HBM)
- Drop-in Replacement for HMC540LP3E

### General Description

The HMC540SLP3E is a broadband 4-bit Silicon IC digital attenuator in a low cost leadless surface mount package. This single positive control line per bit digital attenuator utilizes off chip AC ground capacitors for near DC operation, making it suitable for a wide variety of RF and IF applications. Covering 0.1 to 8 GHz, the insertion loss is less than 1 dB typical. The attenuator bit values are 1 (LSB), 2, 4 and 8 dB for a total attenuation of 15 dB. Attenuation accuracy is excellent at ± 0.2 dB typical step error. The attenuator also features a IIP3 of +56dBm. Four TTL/CMOS control inputs are used to select each attenuation state. It can operate with a single Vdd ranging from +3.3V to 5V.

### Electrical Specifications,

$T_A = +25^\circ\text{C}$ , With  $V_{dd} = +5\text{V}$  &  $V_{ctl} = 0/+5\text{V}$  (Unless Otherwise Noted)

| Parameter   | Frequency (GHz) | Min.            | Typ.                                | Max. | Units |
|---|-----------------|-----------------|-------------------------------------|------|-------|
| Insertion Loss  | 0.1 - 2.0 GHz   |                 | 0.7                                 | 1.1  | dB    |
|   | 2.0 - 3.0 GHz   |                 | 0.8                                 | 1.3  | dB    |
|   | 3.0 - 4.0 GHz   |                 | 0.8                                 | 1.6  | dB    |
|   | 4.0 - 5.5 GHz   |                 | 1.0                                 | 2.6  | dB    |
|   | 5.5 - 8.0 GHz   |                 | 1.7                                 | 3.0  | dB    |
| Attenuation Range                                       | 0.1 - 8 GHz     |                 | 15                                  |      | dB    |
| Return Loss (RF1 & RF2, All Atten. States)              | 0.1 - 3.5 GHz   |                 | 22                                  |      | dB    |
|   | 3.5 - 5.5 GHz   |                 | 17                                  |      | dB    |
|   | 5.5 - 8 GHz     |                 | 12                                  |      | dB    |
| Attenuation Accuracy:<br>(Referenced to Insertion Loss) | All States      | 0.1 - 1.0 GHz   | ± (0.2 + 2% of Atten. Setting) Max. |      | dB    |
|   |                 | 1.0 - 4.0 GHz   | ± (0.2 + 3% of Atten. Setting) Max. |      | dB    |
|   |                 | 4.0 - 5.0 GHz   | ± (0.3 + 5% of Atten. Setting) Max. |      | dB    |
|   |                 | 5.0 - 5.5 GHz   | ± (0.4 + 8% of Atten. Setting) Max. |      | dB    |
|   |                 | 5.5 GHz - 8 GHz | ± (0.5 + 9% of Atten. Setting) Max. |      | dB    |

Information furnished by Analog Devices is believed to be accurate and reliable. However, no responsibility is assumed by Analog Devices for its use, nor for any infringements of patents or other rights of third parties that may result from its use. Specifications subject to change without notice. No license is granted by implication or otherwise under any patent or patent rights of Analog Devices. Trademarks and registered trademarks are the property of their respective owners.

For price, delivery, and to place orders: Analog Devices, Inc., One Technology Way, P.O. Box 9106, Norwood, MA 02062-9106 Phone: 781-329-4700 • Order online at [www.analog.com](http://www.analog.com) Application Support: Phone: 1-800-ANALOG-D

# HMC540S\* PRODUCT PAGE QUICK LINKS

Last Content Update: 02/23/2017

---

## COMPARABLE PARTS

View a parametric search of comparable parts.

## EVALUATION KITS

- HMC540S Evaluation Board

## DOCUMENTATION

### Data Sheet

- HMC540SLP3E: 1 dB LSB Silicon MMIC 4-Bit Digital Positive Control Attenuator, 0.1 - 8 GHz Data Sheet

## TOOLS AND SIMULATIONS

- HMC540S S-Parameter

## DESIGN RESOURCES

- HMC540S Material Declaration
- PCN-PDN Information
- Quality And Reliability
- Symbols and Footprints

## DISCUSSIONS

View all HMC540S EngineerZone Discussions.

## SAMPLE AND BUY

Visit the product page to see pricing options.

## TECHNICAL SUPPORT

Submit a technical question or find your regional support number.

## DOCUMENT FEEDBACK

Submit feedback for this data sheet.

---

## 1 dB LSB SILICON MMIC 4-BIT DIGITAL POSITIVE CONTROL ATTENUATOR, 0.1 - 8 GHz

| Parameter   | Frequency (GHz) | Min. | Typ.     | Max. | Units |
|---|-----------------|------|----------|------|-------|
| Input Power for 0.1 dB Compression  | 0.1 - 8 GHz     |      | 31       |      | dBm   |
| Input Third Order Intercept Point<br>(Two-Tone Input Power= 12 dBm Each Tone) | 0.1 - 8 GHz     |      | 57<br>55 |      | dBm   |
| Switching Characteristics   | DC - 8 GHz      |      |          |      |       |
| tRISE, tFALL (10/90% RF)  |                 |      | 45       |      | ns    |
| tON, tOFF (50% CTL to 10/90% RF)  |                 |      | 129      |      | ns    |

### Frequency Response Plots up to 6 GHz

#### Insertion Loss

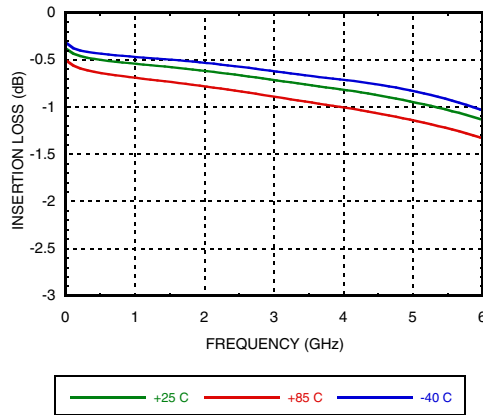

#### Return Loss RF1, RF2 (Only Major States are Shown)

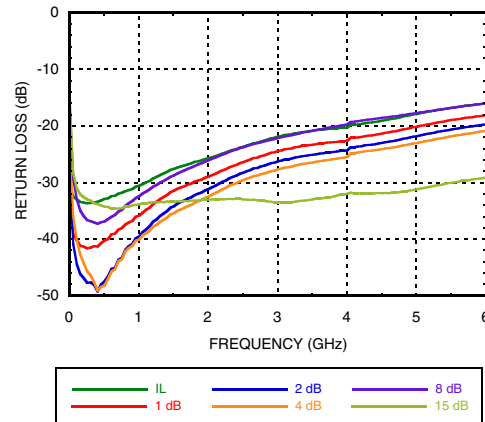

#### Normalized Attenuation (Only Major States are Shown)

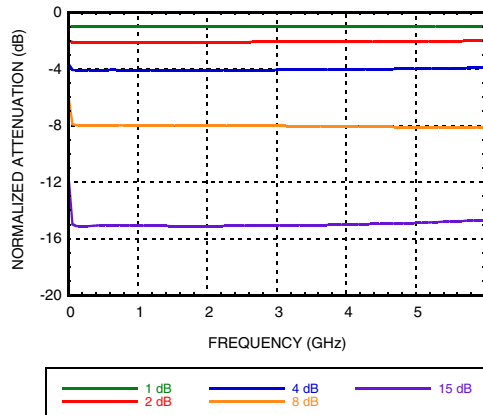

#### Bit Error vs. Attenuation State

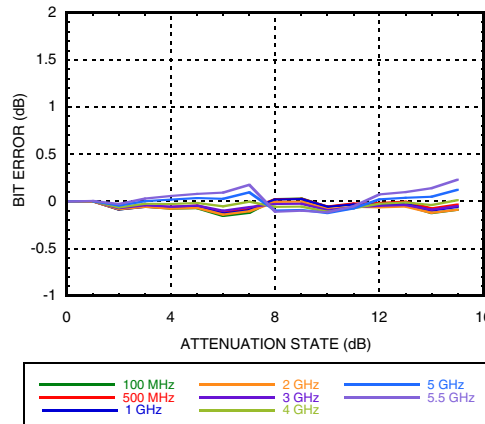

Information furnished by Analog Devices is believed to be accurate and reliable. However, no responsibility is assumed by Analog Devices for its use, nor for any infringements of patents or other rights of third parties that may result from its use. Specifications subject to change without notice. No license is granted by implication or otherwise under any patent or patent rights of Analog Devices. Trademarks and registered trademarks are the property of their respective owners.

For price, delivery, and to place orders: Analog Devices, Inc., One Technology Way, P.O. Box 9106, Norwood, MA 02062-9106 Phone: 781-329-4700 • Order online at [www.analog.com](http://www.analog.com) Application Support: Phone: 1-800-ANALOG-D

## 1 dB LSB SILICON MMIC 4-BIT DIGITAL POSITIVE CONTROL ATTENUATOR, 0.1 - 8 GHz

### Bit Error vs. Frequency

(Only Major States are Shown)

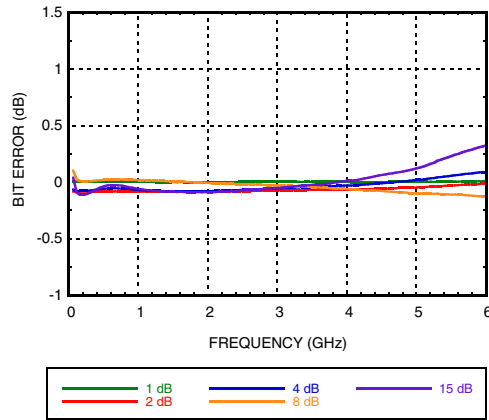

### Relative Phase vs. Frequency

(Only Major States are Shown)

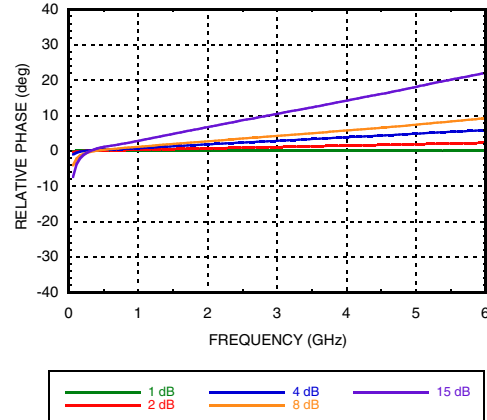

### Step Error vs Frequency (Major States)

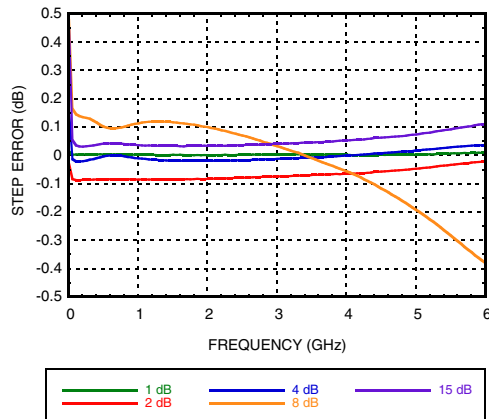

Information furnished by Analog Devices is believed to be accurate and reliable. However, no responsibility is assumed by Analog Devices for its use, nor for any infringements of patents or other rights of third parties that may result from its use. Specifications subject to change without notice. No license is granted by implication or otherwise under any patent or patent rights of Analog Devices. Trademarks and registered trademarks are the property of their respective owners.

For price, delivery, and to place orders: Analog Devices, Inc., One Technology Way, P.O. Box 9106, Norwood, MA 02062-9106 Phone: 781-329-4700 • Order online at [www.analog.com](http://www.analog.com) Application Support: Phone: 1-800-ANALOG-D

## 1 dB LSB SILICON MMIC 4-BIT DIGITAL POSITIVE CONTROL ATTENUATOR, 0.1 - 8 GHz

**Frequency Response Plots up to 10 GHz**  
**Insertion Loss**

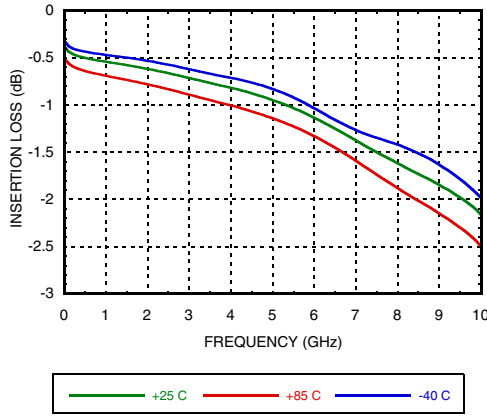

**Return Loss RF1, RF2**  
(Only Major States are Shown)

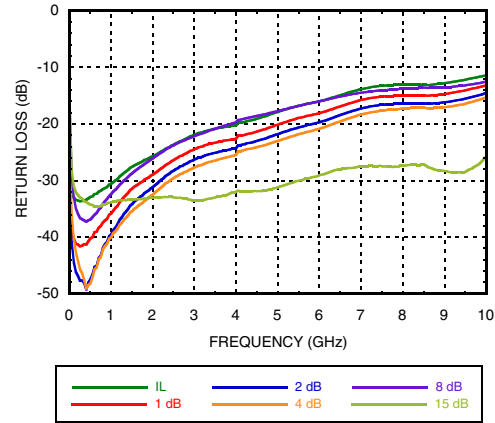

**Normalized Attenuation**  
(Only Major States are Shown)

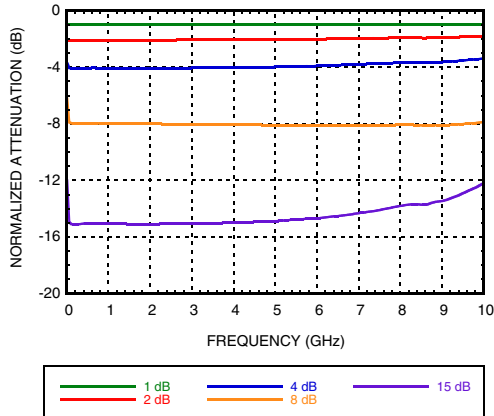

**Bit Error vs. Attenuation State**

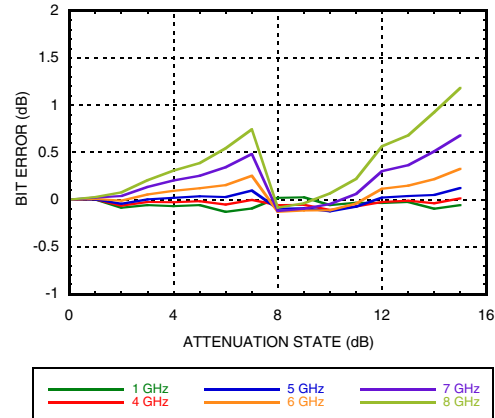

**Bit Error vs. Frequency**  
(Only Major States are Shown)

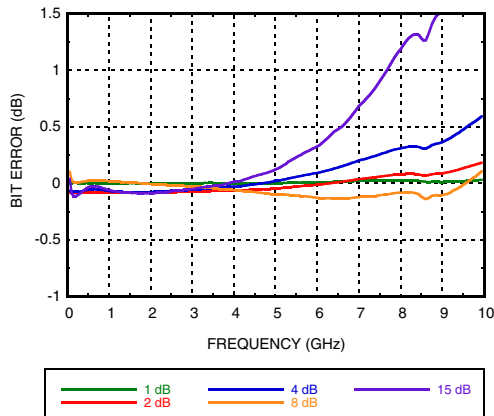

**Relative Phase vs. Frequency**  
(Only Major States are Shown)

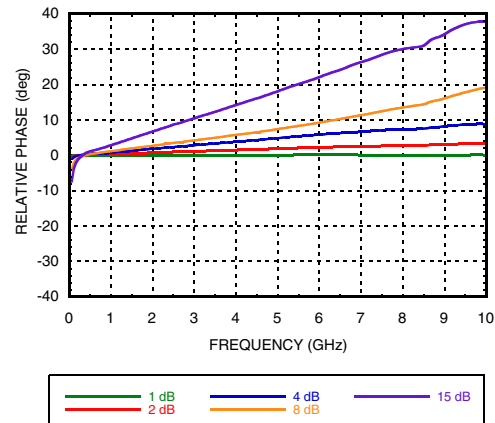

Information furnished by Analog Devices is believed to be accurate and reliable. However, no responsibility is assumed by Analog Devices for its use, nor for any infringements of patents or other rights of third parties that may result from its use. Specifications subject to change without notice. No license is granted by implication or otherwise under any patent or patent rights of Analog Devices. Trademarks and registered trademarks are the property of their respective owners.

For price, delivery, and to place orders: Analog Devices, Inc., One Technology Way, P.O. Box 9106, Norwood, MA 02062-9106 Phone: 781-329-4700 • Order online at [www.analog.com](http://www.analog.com) Application Support: Phone: 1-800-ANALOG-D

**1 dB LSB SILICON MMIC 4-BIT DIGITAL  
POSITIVE CONTROL ATTENUATOR, 0.1 - 8 GHz**

**Step Error vs Frequency (Major States)**

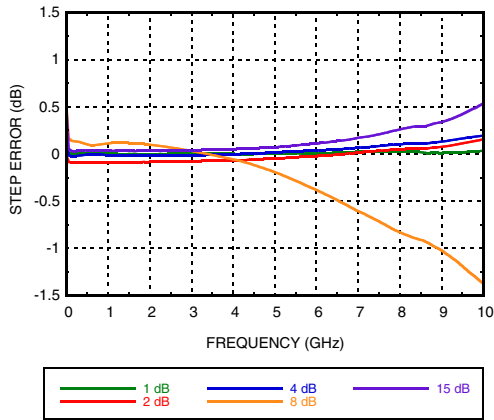

## 1 dB LSB SILICON MMIC 4-BIT DIGITAL POSITIVE CONTROL ATTENUATOR, 0.1 - 8 GHz

**Power Handling up to 8 GHz  
Input Third Order Intercept Point over  
Temp., 5V (100 MHz - 8 GHz)**

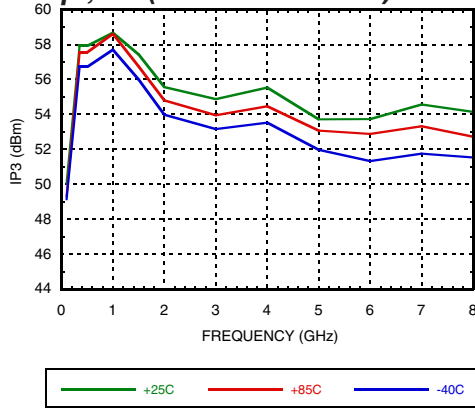

**Input Third Order Intercept Point over  
Temp., 3.3V (100 MHz - 8 GHz)**

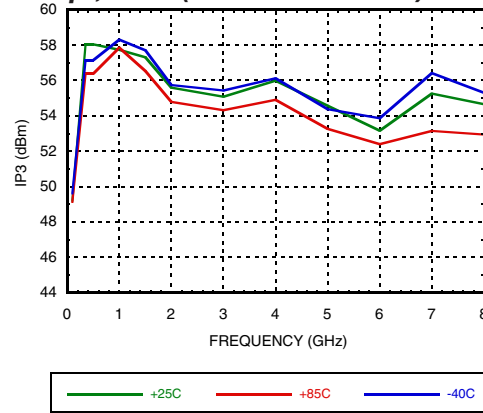

**0.1 and 1 dB Input Compression Point, 5V  
(100 MHz - 8 GHz)**

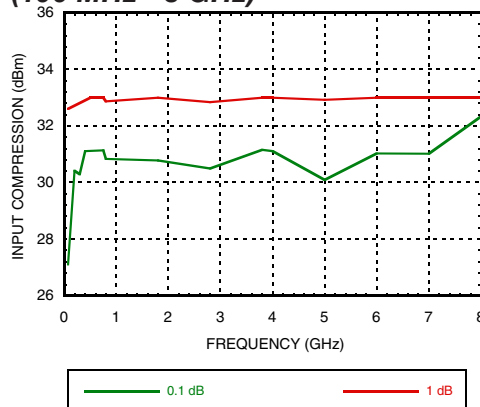

**1 dB Input Compression Point, Over  
Temp., 5V (100 MHz - 8 GHz)**

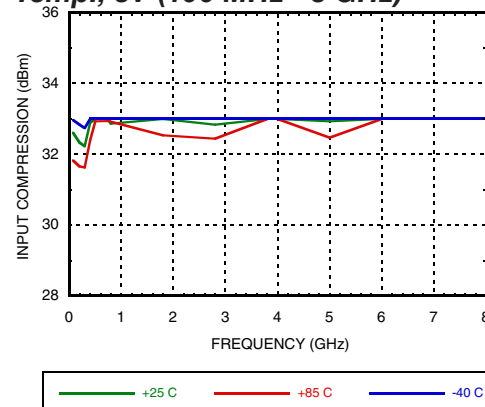

**0.1 and 1 dB Input Compression Point,  
3.3V (100 MHz - 8 GHz)**

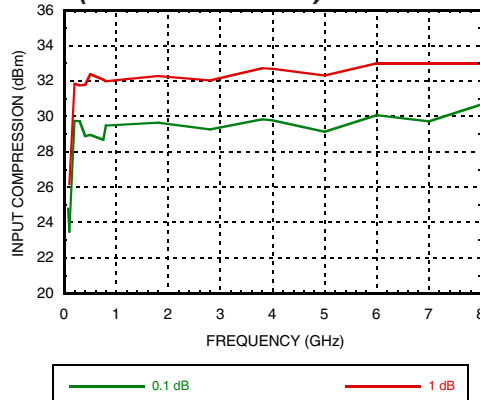

**1 dB Input Compression Point, Over  
Temp., 3.3V (100 MHz - 8 GHz)**

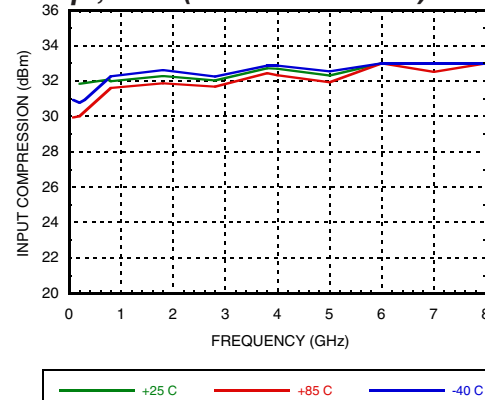

Information furnished by Analog Devices is believed to be accurate and reliable. However, no responsibility is assumed by Analog Devices for its use, nor for any infringements of patents or other rights of third parties that may result from its use. Specifications subject to change without notice. No license is granted by implication or otherwise under any patent or patent rights of Analog Devices. Trademarks and registered trademarks are the property of their respective owners.

For price, delivery, and to place orders: Analog Devices, Inc., One Technology Way, P.O. Box 9106, Norwood, MA 02062-9106 Phone: 781-329-4700 • Order online at [www.analog.com](http://www.analog.com) Application Support: Phone: 1-800-ANALOG-D



## 1 dB LSB SILICON MMIC 4-BIT DIGITAL POSITIVE CONTROL ATTENUATOR, 0.1 - 8 GHz

### Absolute Maximum Ratings

|   |                   |
|---|-------------------|
| RF Input Power at 85 °C                           | +27 dBm           |
| RF Input Power at 105 °C                          | +25 dBm           |
| Bias Voltage (Vdd)                                | -0.3V to 5.4V     |
| Control Voltage Range (V1 to V4)                  | -0.3V to Vdd +.5V |
| Channel Temperature                               | 140 °C            |
| Thermal Resistance (at maximum power dissipation) | 110 °C/W          |
| ESD Sensitivity (HBM)                             | Class 2           |
| Storage Temperature                               | -65 to +150 °C    |

### Recommended Operation Ratings

|                                  |                |
|----------------------------------|----------------|
| RF Input Power at 85 °C          | +24 dBm        |
| RF Input Power at 105 °C         | +23 dBm        |
| Bias Voltage (Vdd)               | 3V to 5.4V     |
| Control Voltage Range (V1 to V4) | 0 to Vdd       |
| Operating Temperature            | -40 to +105 °C |



ELECTROSTATIC SENSITIVE DEVICE  
OBSERVE HANDLING PRECAUTIONS

### Bias Voltage & Current

| Vdd (V) | Idd (Typ.) (mA) |
|---------|-----------------|
| +3.3    | 0.14            |
| +5.0    | 0.17            |

### Control Voltage

| State | Vdd = +3.3V        | Vdd = +5V           |
|-------|--------------------|---------------------|
| Low   | 0 to 0.5V @ < 1 uA | 0 to +0.8V @ < 1 uA |
| High  | 2 to 3.3V @ 25 uA  | 2 to 5V @ 35 uA     |

### Truth Table

| Control Voltage Input |            |            |            | Attenuation State<br>RF1 - RF2 |
|-----------------------|------------|------------|------------|--------------------------------|
| V1<br>8 dB            | V2<br>4 dB | V3<br>2 dB | V4<br>1 dB |                                |
| High                  | High       | High       | High       | Reference I.L.                 |
| High                  | High       | High       | Low        | 1 dB                           |
| High                  | High       | Low        | High       | 2 dB                           |
| High                  | Low        | High       | High       | 4 dB                           |
| Low                   | High       | High       | High       | 8 dB                           |
| Low                   | Low        | Low        | Low        | 15 dB                          |

Any combination of the above states will provide an attenuation approximately equal to the sum of the bits selected.

## 1 dB LSB SILICON MMIC 4-BIT DIGITAL POSITIVE CONTROL ATTENUATOR, 0.1 - 8 GHz

### Outline Drawing

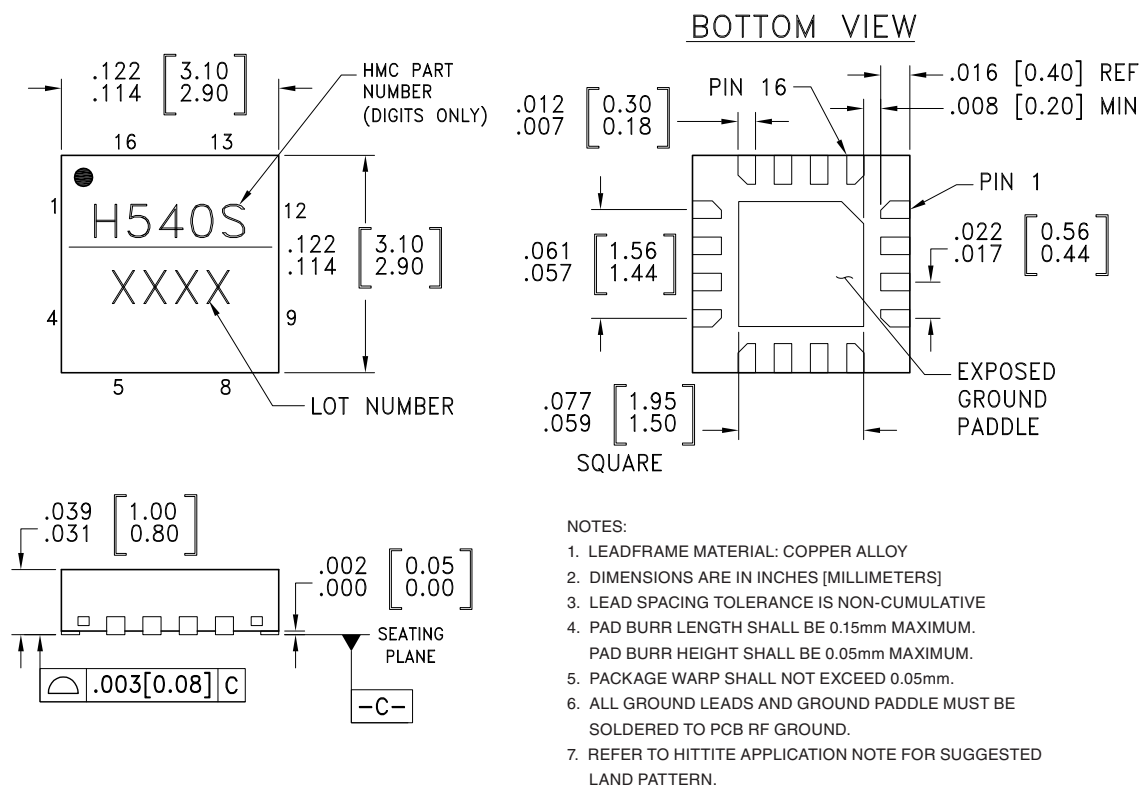

### Package Information

| Part Number | Package Body Material                              | Lead Finish   | MSL Rating          | Package Marking <sup>[3]</sup> |
|-------------|--|---------------|---------------------|--------------------------------|
| HMC540SLP3E | RoHS-compliant Low Stress Injection Molded Plastic | 100% matte Sn | MSL3 <sup>[2]</sup> | H540S<br>XXXX                  |

[1] Max peak reflow temperature of 235 °C

[2] Max peak reflow temperature of 260 °C

[3] 4-Digit lot number XXXX

## 1 dB LSB SILICON MMIC 4-BIT DIGITAL POSITIVE CONTROL ATTENUATOR, 0.1 - 8 GHz

### Pin Descriptions

| Pin Number      | Function    | Description   | Interface Schematic |
|-----------------|-------------|---|---------------------|
| 1               | Vdd         | Supply Voltage.   |                     |
| 2, 11           | RF1, RF2    | This pin is DC coupled and matched to 50 Ohm. Blocking capacitors are required. Select value based on lowest frequency of operation.    |                     |
| 3, 7, 9, 10, 12 | N/C         | These pins should be connected to PCB RF ground to maximize performance.  |                     |
| 4 - 6, 8        | ACG1 - ACG4 | External capacitor to ground is required. Select value for lowest frequency of operation. Place capacitor as close to pins as possible. |                     |
| 13 - 16         | V1 - V4     | See truth table and control voltage table.  |                     |
|                 | GND         | Package bottom has an exposed metal paddle that must be connected to RF/DC Ground.  |                     |

### Application Circuit

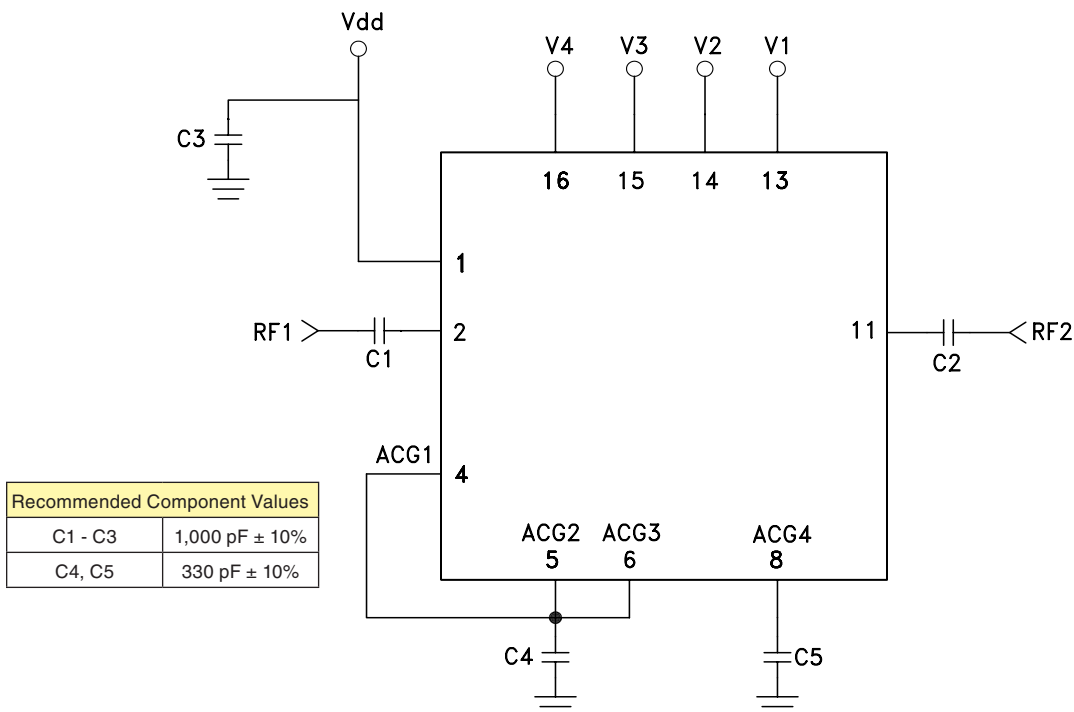

Information furnished by Analog Devices is believed to be accurate and reliable. However, no responsibility is assumed by Analog Devices for its use, nor for any infringements of patents or other rights of third parties that may result from its use. Specifications subject to change without notice. No license is granted by implication or otherwise under any patent or patent rights of Analog Devices. Trademarks and registered trademarks are the property of their respective owners.

For price, delivery, and to place orders: Analog Devices, Inc., One Technology Way, P.O. Box 9106, Norwood, MA 02062-9106 Phone: 781-329-4700 • Order online at [www.analog.com](http://www.analog.com) Application Support: Phone: 1-800-ANALOG-D

## 1 dB LSB SILICON MMIC 4-BIT DIGITAL POSITIVE CONTROL ATTENUATOR, 0.1 - 8 GHz

### Evaluation PCB

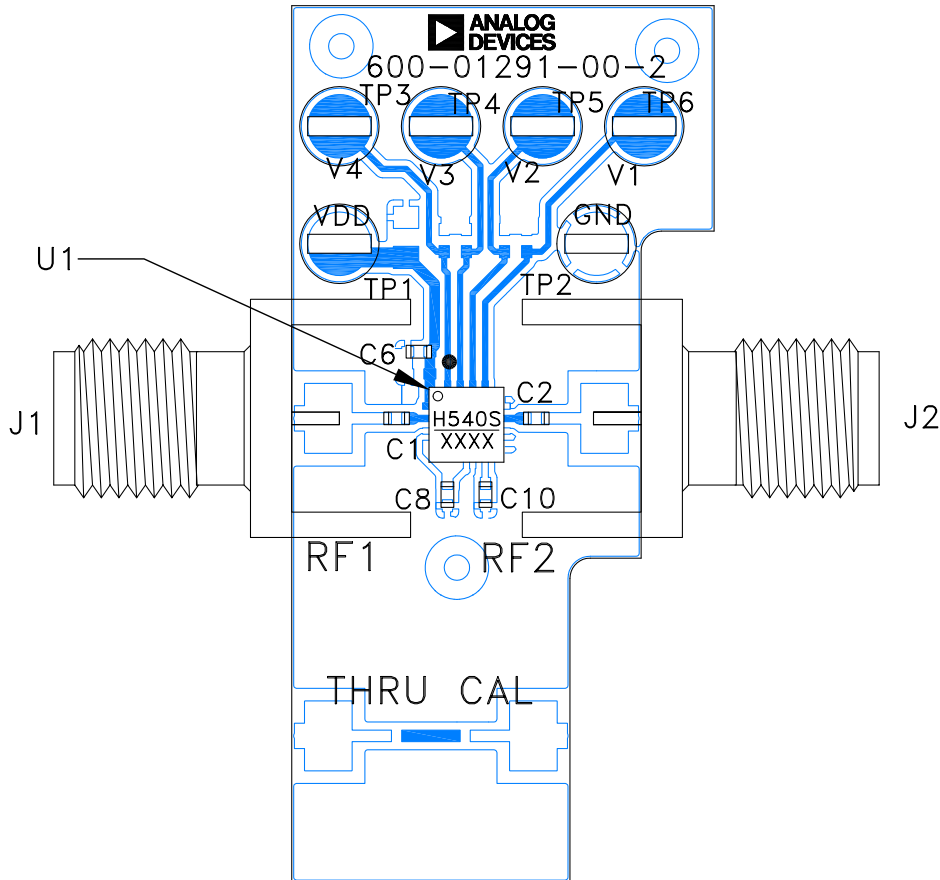

### List of Materials for Evaluation PCB EV1HMC540SLP3<sup>[1]</sup>

| Item       | Description                    |
|------------|--------------------------------|
| J1, J2     | PCB Mount SMA Connector        |
| TP1 - TP6  | Thru Hole Mount Test Point     |
| C1, C2, C6 | 1000 pF Capacitor, 0402 Pkg.   |
| C8, C10    | 330 pF Capacitor, 0402 Pkg.    |
| U1         | HMC540SLP3E Digital Attenuator |
| PCB [2]    | 600-01291-00 Evaluation PCB    |

[1] Reference this number when ordering complete evaluation PCB

[2] Circuit Board Material: Rogers 4350

The circuit board used in the application should use RF circuit design techniques. Signal lines should have 50 Ohm impedance while the package ground leads and exposed paddle should be connected directly to the ground plane similar to that shown. A sufficient number of via holes should be used to connect the top and bottom ground planes. The evaluation circuit board shown is available from Analog Devices upon request.