



Chipsmall Limited consists of a professional team with an average of over 10 year of expertise in the distribution of electronic components. Based in Hongkong, we have already established firm and mutual-benefit business relationships with customers from,Europe,America and south Asia,supplying obsolete and hard-to-find components to meet their specific needs.

With the principle of “Quality Parts,Customers Priority,Honest Operation,and Considerate Service”,our business mainly focus on the distribution of electronic components. Line cards we deal with include Microchip,ALPS,ROHM,Xilinx,Pulse,ON,Everlight and Freescale. Main products comprise IC,Modules,Potentiometer,IC Socket,Relay,Connector.Our parts cover such applications as commercial,industrial, and automotives areas.

We are looking forward to setting up business relationship with you and hope to provide you with the best service and solution. Let us make a better world for our industry!



Contact us

Tel: +86-755-8981 8866 Fax: +86-755-8427 6832

Email & Skype: info@chipsmall.com Web: www.chipsmall.com

Address: A1208, Overseas Decoration Building, #122 Zhenhua RD., Futian, Shenzhen, China





GaAs MMIC T/R SWITCH, DC - 4 GHz

Typical Applications

The HMC544A / 544AE is ideal for:

- Cellular/PCS/3G Infrastructure
- Basestations & Repeaters
- WLAN, WiMAX and WiBro
- Microwave and Fixed Wireless Radios

Features

- Very Low Insertion Loss: 0.2 dB @ 1.0 GHz
- High Input P1dB: +39 dBm
- High Input IP3: +60 dBm
- Positive Control: 0/+3V to 0/+5V
- Compact SOT26 SMT Package

Functional Diagram

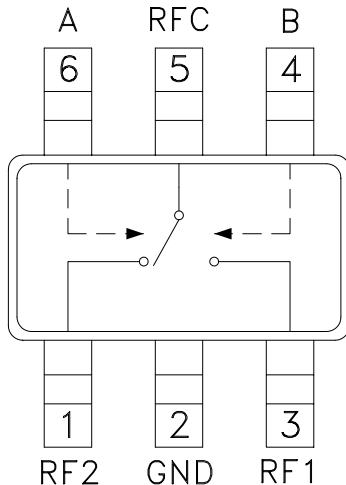

General Description

The HMC544A & HMC544AE are low cost SPDT switches in 6-lead SOT26 packages for use in transmit-receive applications which require very low insertion loss at medium power levels. These devices can control signals from DC to 4.0 GHz and are especially suited for 450, 900, 1900, 2300, and 2700 MHz applications with <0.5 dB insertion loss. This GaAs PHEMT design provides exceptional linearity performance of +36 dBm 1dB compression point and +60 dBm third order intercept at +3 volt bias. RF1 and RF2 are reflective opens when "Off". On-chip circuitry allows positive control operation at very low DC current.

Electrical Specifications, $T_A = +25^\circ C$, $V_{ctl} = 0/+3 Vdc$, 50 Ohm System

Parameter	Frequency	Min.	Typ.	Max.	Units
Insertion Loss	DC - 1.0 GHz		0.25	0.5	dB
	DC - 2.5 GHz		0.4	0.7	dB
	DC - 3.0 GHz		0.5	0.8	dB
	DC - 4 GHz		0.7	1.0	dB
Isolation	DC - 1.0 GHz	18	23		dB
	DC - 2.5 GHz	11	16		dB
	DC - 3.0 GHz	9	14		dB
	DC - 4 GHz	8	12		dB
Return Loss	DC - 4 GHz		28		dB
Input Power for 1 dB Compression	0.3 - 4.0 GHz	0/+5V Control	36	39	dBm
		0/+3V Control	33	35	dBm
Input Third Order Intercept (Two-Tone Input Power = +13 dBm Each Tone)	0.3 - 4.0 GHz		60		dBm
Switching Characteristics	DC - 4 GHz				
		tRISE, tFALL (10/90% RF)		30	ns
		tON, tOFF (50% CTL to 10/90% RF)		50	ns

Information furnished by Analog Devices is believed to be accurate and reliable. However, no responsibility is assumed by Analog Devices for its use, nor for any infringements of patents or other rights of third parties that may result from its use. Specifications subject to change without notice. No license is granted by implication or otherwise under any patent or patent rights of Analog Devices. Trademarks and registered trademarks are the property of their respective owners.

For price, delivery, and to place orders: Analog Devices, Inc., One Technology Way, P.O. Box 9106, Norwood, MA 02062-9106
Phone: 781-329-4700 • Order online at www.analog.com
Application Support: Phone: 1-800-ANALOG-D



Insertion Loss

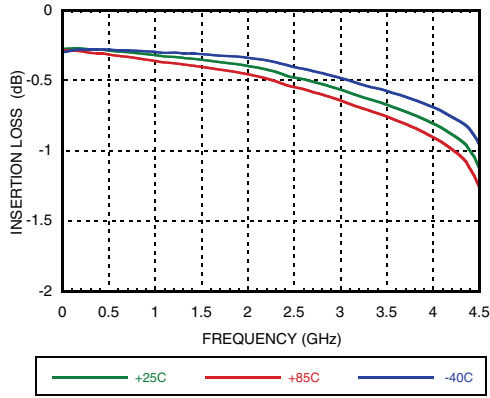

Return Loss

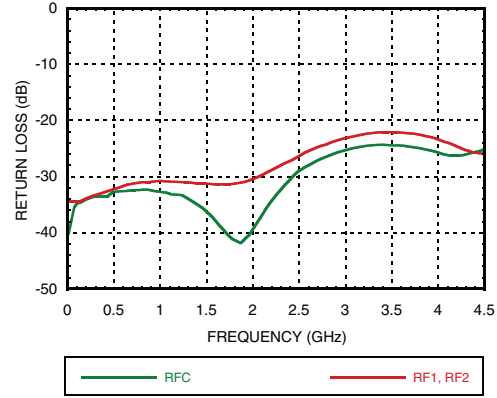

Isolation Between Ports RFC & RF1 / RF2

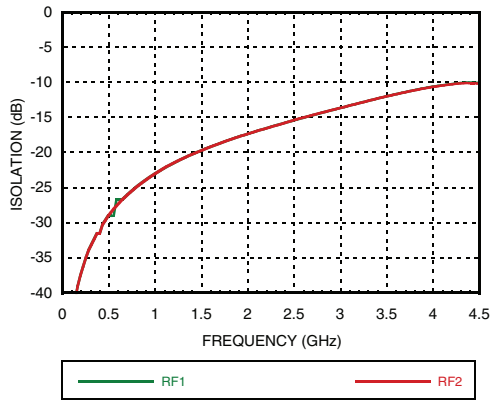

Isolation Between Ports RF1 & RF2

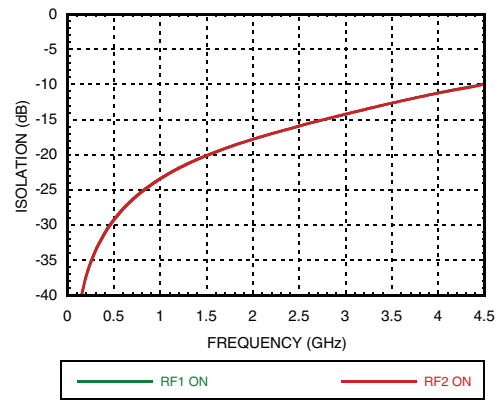

Input IP3 vs. Temperature, Vctl = 0/+3V

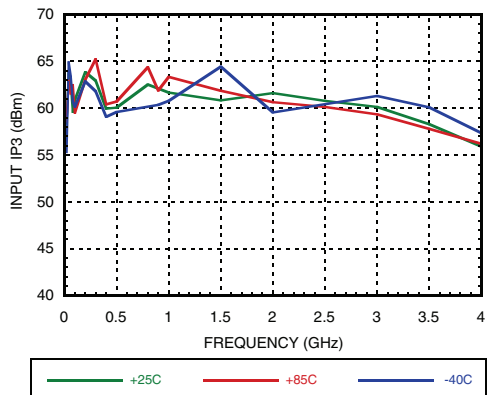

Input IP3 vs. Vctl

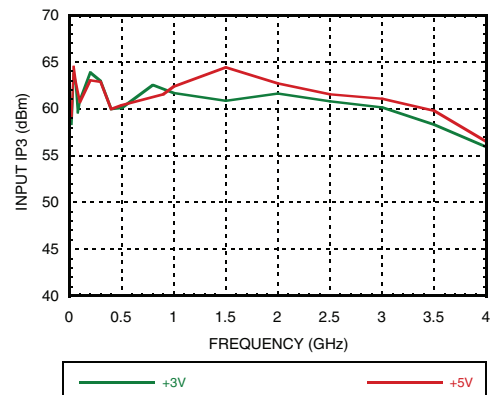



**GaAs MMIC T/R SWITCH,
DC - 4 GHz**

Input P1dB vs. Temperature, Vctl = 0/+3V

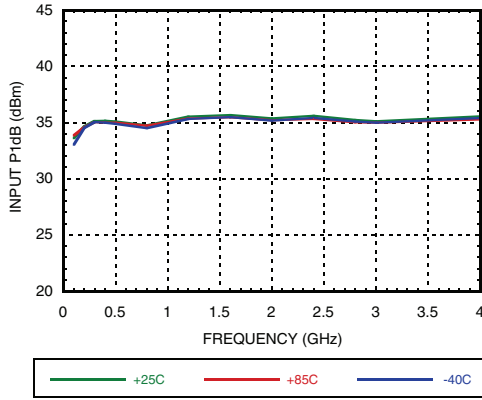

Compression vs. Vctl

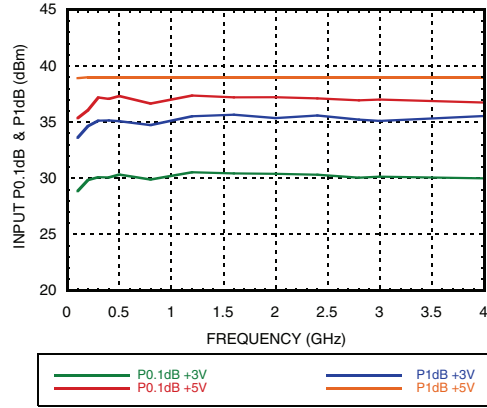

Truth Table

Control Input		Signal Path	
A	B	RFC to RF1	RFC to RF2
Low	High	On	Off
High	Low	Off	On

Control Voltages

State	Bias Condition
Low	0 to 0.2 Vdc @ 1 μ A Typical
High	+3 Vdc @ 0.5 μ A Typical to +5 Vdc @ 1 μ A Typical (\pm 0.2 Vdc)

Information furnished by Analog Devices is believed to be accurate and reliable. However, no responsibility is assumed by Analog Devices for its use, nor for any infringements of patents or other rights of third parties that may result from its use. Specifications subject to change without notice. No license is granted by implication or otherwise under any patent or patent rights of Analog Devices. Trademarks and registered trademarks are the property of their respective owners.

For price, delivery, and to place orders: Analog Devices, Inc., One Technology Way, P.O. Box 9106, Norwood, MA 02062-9106 Phone: 781-329-4700 • Order online at www.analog.com Application Support: Phone: 1-800-ANALOG-D

Absolute Maximum Ratings

RF Input Power (Vctl = 0/+5V)	+39 dBm
Control Voltage Range (A & B)	-0.2 to +12 Vdc
Hot Switch Power Level (Vctl = 0/+5V)	+39 dBm
Channel Temperature	150 °C
Continuous Pdiss (T= 85 °C) (derate 8.85 mW/ °C above 85°C)	0.574 W
Thermal Resistance	113.3 °C/W
Storage Temperature	-65 to +150 °C
Operating Temperature	-40 to +85 °C
ESD Sensitivity (HBM)	Class 1B

DC blocks are required at ports RFC, RF1 and RF2.

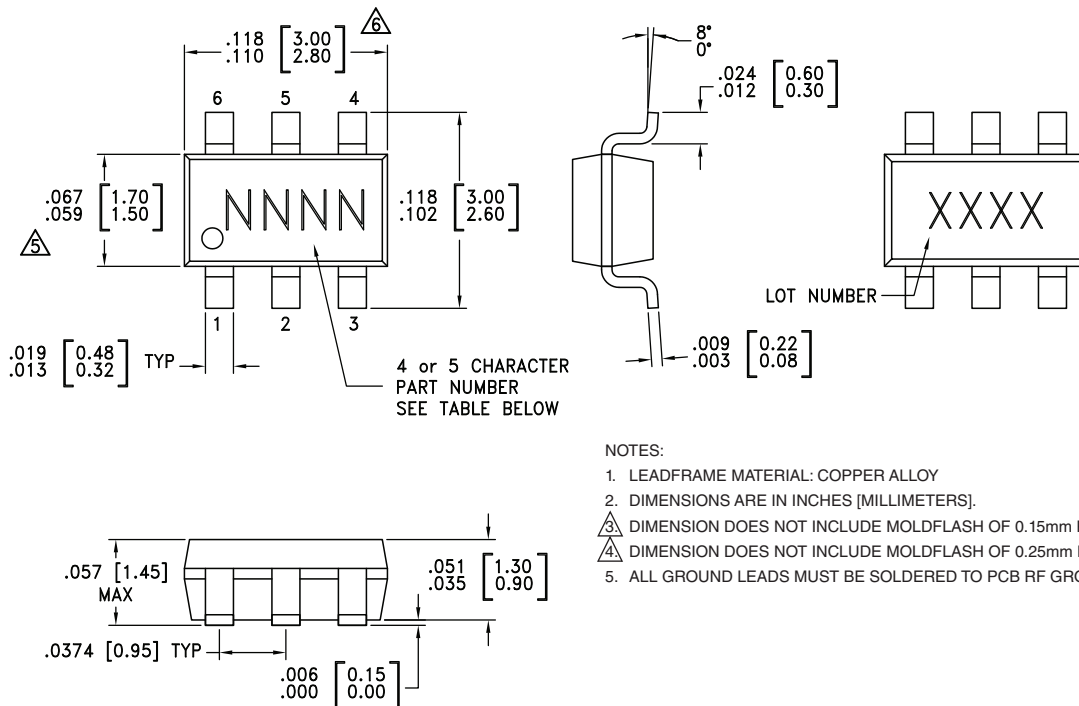
**ELECTROSTATIC SENSITIVE DEVICE
OBSERVE HANDLING PRECAUTIONS**
Outline Drawing

Package Information

Part Number	Package Body Material	Lead Finish	MSL Rating	Package Marking ^[3]
HMC544A	Low Stress Injection Molded Plastic	Sn/Pb Solder	MSL1 ^[1]	544A XXXX
HMC544AE	RoHS-compliant Low Stress Injection Molded Plastic	100% matte Sn	MSL1 ^[2]	544AE XXXX

^[1] Max peak reflow temperature of 235 °C

^[2] Max peak reflow temperature of 260 °C

^[3] 4-Digit lot number XXXX



**GaAs MMIC T/R SWITCH,
DC - 4 GHz**

Typical Application Circuit

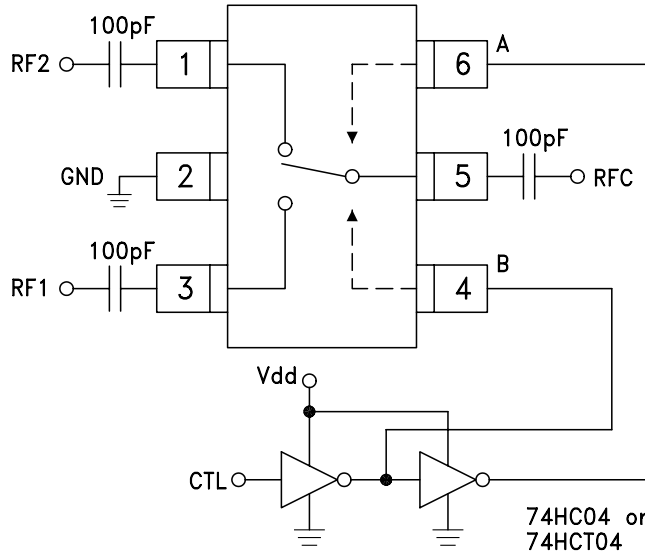

Notes:

1. Set logic gate Vdd = +3V to +5V and use HCT series logic to provide a TTL driver interface.
2. Control inputs A/B can be driven directly with CMOS logic (HC) with Vdd of +3V to +5V applied to the CMOS logic gates.
3. DC Blocking capacitors are required for each RF port as shown. Capacitor value determines lowest frequency of operation.

Pin Descriptions

Pin Number	Function	Description	Interface Schematic
1, 3, 5	RF2, RF1, RFC	These pins are DC coupled and matched to 50 Ohms. Blocking capacitors are required.	
2	GND	This pin must be connected to RF/DC ground.	
4	B	See truth and control voltage tables.	
6	A	See truth and control voltage tables.	



Evaluation Circuit Board

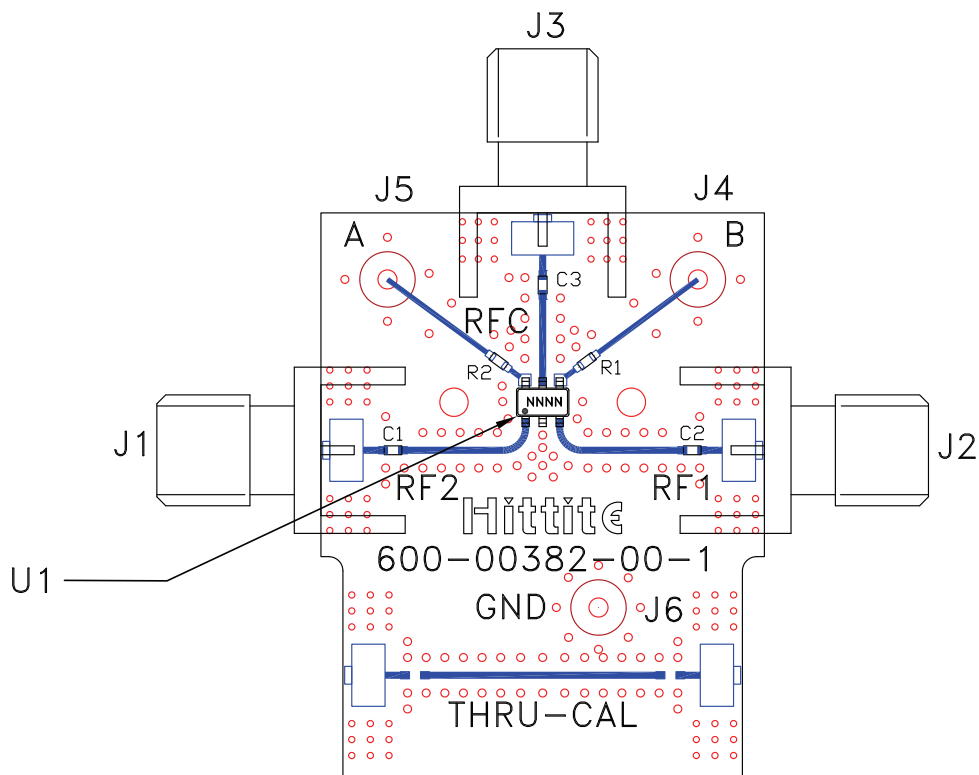

List of Materials for Evaluation PCB EVAL01-HMC544A [1]

Item	Description
J1 - J3	PCB Mount SMA RF Connector
J4 - J6	DC Pin
C1 - C2	330 pF capacitor, 0402 Pkg.
R1 - R2	1 KOhm resistor, 0402 Pkg.
U1	HMC544A / 544AE SPDT Switch
PCB [2]	600-00382-00-1 Evaluation PCB

[1] Reference this number when ordering complete evaluation PCB

[2] Circuit Board Material: Rogers 4350

The circuit board used in the application should be generated with proper RF circuit design techniques. Signal lines at the RF port should have 50 Ohm impedance and the package ground leads should be connected directly to the ground plane similar to that shown above. The evaluation circuit board shown above is available from Hittite Microwave Corporation upon request.