



Chipsmall Limited consists of a professional team with an average of over 10 year of expertise in the distribution of electronic components. Based in Hongkong, we have already established firm and mutual-benefit business relationships with customers from,Europe,America and south Asia,supplying obsolete and hard-to-find components to meet their specific needs.

With the principle of “Quality Parts,Customers Priority,Honest Operation,and Considerate Service”,our business mainly focus on the distribution of electronic components. Line cards we deal with include Microchip,ALPS,ROHM,Xilinx,Pulse,ON,Everlight and Freescale. Main products comprise IC,Modules,Potentiometer,IC Socket,Relay,Connector.Our parts cover such applications as commercial,industrial, and automotives areas.

We are looking forward to setting up business relationship with you and hope to provide you with the best service and solution. Let us make a better world for our industry!



Contact us

Tel: +86-755-8981 8866 Fax: +86-755-8427 6832

Email & Skype: info@chipsmall.com Web: www.chipsmall.com

Address: A1208, Overseas Decoration Building, #122 Zhenhua RD., Futian, Shenzhen, China



FEATURES

High input P0.1dB: 40 dBm Tx
Low insertion loss: 0.4 dB
High input IP3: 67 dBm
Positive control: 0 V low control; 3 V to 8 V high control
Failsafe operation: Tx is on when no dc power is applied

APPLICATIONS

LNA protection, WiMAX, and WiBro
Cellular, PCS, 3G, and TD-SCDMA infrastructure
Private mobile radio and public safety handsets
Automotive telematics

GENERAL DESCRIPTION

The [HMC546LP2E](#) is a failsafe SPDT switch in a leadless DFN surface-mount plastic package for use in transmit/receive and LNA protection applications that require very low distortion and high power handling of up to 10 watts.

The [HMC546LP2E](#) requires external matching and is suitable for narrow-band applications within 200 MHz to 2700 MHz.

FUNCTIONAL BLOCK DIAGRAM

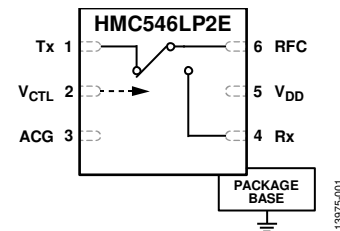

Figure 1.

This narrow-band switch is well suited for WiMAX and WiBro repeaters, private mobile radio (PMR), and automotive telematic applications. The design provides exceptional P0.1dB of 40 dBm and IIP3 of 65 dBm on the transmit (Tx) port. The failsafe topology allows the switch to provide a low loss path from RFC to Tx, when no dc power is available.

HMC546LP2E* PRODUCT PAGE QUICK LINKS

Last Content Update: 02/23/2017

COMPARABLE PARTS

View a parametric search of comparable parts.

EVALUATION KITS

- HMC546LP2 Evaluation Board.
- Two Channels, 2400MHz TDD Application

DOCUMENTATION

Data Sheet

- HMC546LP2E:10 W, Failsafe, GaAs, SPDT Switch 0.2 GHz to 2.7 GHz Data Sheet

REFERENCE MATERIALS

Quality Documentation

- HMC Legacy PCN: LP2E and LP2 QFN - Alternative Assembly Source
- Package/Assembly Qualification Test Report: LP2, LP2C, LP3, LP3B, LP3C, LP3D, LP3F, LP3G (QTR: 2014-0364)
- Semiconductor Qualification Test Report: PHEMT-B (QTR: 2013-00233)

DESIGN RESOURCES

- HMC546LP2E Material Declaration
- PCN-PDN Information
- Quality And Reliability
- Symbols and Footprints

DISCUSSIONS

View all HMC546LP2E EngineerZone Discussions.

SAMPLE AND BUY

Visit the product page to see pricing options.

TECHNICAL SUPPORT

Submit a technical question or find your regional support number.

DOCUMENT FEEDBACK

Submit feedback for this data sheet.

TABLE OF CONTENTS

Features	1	1843 MHz Tuning	7
Applications.....	1	2015 MHz Tuning	8
Functional Block Diagram	1	2350 MHz Tuning	9
General Description	1	2600 MHz Tuning	10
Revision History	2	Applications Information	11
Specifications.....	3	Components for Selected Frequencies	11
Absolute Maximum Ratings.....	5	Evaluation PCB.....	12
ESD Caution.....	5	Outline Dimensions	13
Pin Configuration and Function Descriptions.....	6	Ordering Guide	13
Interface Schematics	6		
Typical Performance Characteristics	7		

REVISION HISTORY

This Hittite Microwave Products data sheet has been reformatted to meet the styles and standards of Analog Devices, Inc.

5/2016—v.04.1115 to Rev. E

Updated Format	Universal
Deleted HMC546LP2.....	Throughout
Deleted Table 2, Renumbered Sequentially.....	4
Added Pin Function Descriptions, Table 5, Renumbered Sequentially	7
Changes to Table 7.....	13
Updated Outline Dimensions	14
Changes to Ordering Guide	14

SPECIFICATIONS

$T_A = 25^\circ\text{C}$, $V_{DD} = 0\text{ V}/3\text{ V dc}$, $V_{CTL} = 0\text{ V}/3\text{ V dc}$, $50\ \Omega$ system. Specifications and data reflect measurements using the respective application circuit components for each frequency band as listed in Table 1.

Table 1.

Parameter	Symbol	Test Conditions/Comments	Min	Typ	Max	Unit
FREQUENCY RANGE			200		2700	MHz
INSERTION LOSS						
Tx to RFC		f = 1805 MHz to 1910 MHz		0.3	0.6	dB
		f = 2010 MHz to 2025 MHz		0.4	0.7	dB
		f = 2300 MHz to 2480 MHz		0.6	0.8	dB
		f = 2500 MHz to 2700 MHz		0.5	0.8	dB
RFC to Rx		f = 1805 MHz to 1910 MHz		0.4	0.7	dB
		f = 2010 MHz to 2025 MHz		0.3	0.6	dB
		f = 2300 MHz to 2480 MHz		1.1	1.5	dB
		f = 2500 MHz to 2700 MHz		0.7	1.1	dB
ISOLATION						
Tx to RFC		f = 1805 MHz to 1910 MHz	15	23		dB
		f = 2010 MHz to 2025 MHz	14	22		dB
		f = 2300 MHz to 2480 MHz	15	20		dB
		f = 2500 MHz to 2700 MHz	10	15		dB
RFC to Rx		f = 1805 MHz to 1910 MHz	22	30		dB
		f = 2010 MHz to 2025 MHz	20	27		dB
		f = 2300 MHz to 2480 MHz	25	30		dB
		f = 2500 MHz to 2700 MHz	30	40		dB
RETURN LOSS						
Tx to RFC		f = 1805 MHz to 1910 MHz		25		dB
		f = 2010 MHz to 2025 MHz		20		dB
		f = 2300 MHz to 2480 MHz		22		dB
		f = 2500 MHz to 2700 MHz		20		dB
RFC to Rx		f = 1805 MHz to 1910 MHz		25		dB
		f = 2010 MHz to 2025 MHz		25		dB
		f = 2300 MHz to 2480 MHz		10		dB
		f = 2500 MHz to 2700 MHz		12		dB
INPUT LINEARITY						
0.1 dB Power Compression						
Tx to RFC	P0.1dB	f = 1805 MHz to 1910 MHz	38	40		dBm
		f = 2010 MHz to 2025 MHz	39	41		dBm
		f = 2300 MHz to 2480 MHz	36.5	38.5		dBm
		f = 2500 MHz to 2700 MHz	38.5	40.5		dBm
RFC to Rx		f = 1805 MHz to 1910 MHz	19	21		dBm
		f = 2010 MHz to 2025 MHz	19	21		dBm
		f = 2300 MHz to 2480 MHz	17	19		dBm
		f = 2500 MHz to 2700 MHz	18	20		dBm
Input Third-Order Intercept						
Tx to RFC	IP3	Two-tone input power = 19 dBm/tone, $\Delta f = 1\text{ MHz}$				
		f = 1805 MHz to 1910 MHz		65		dBm
		f = 2010 MHz to 2025 MHz		64		dBm
		f = 2300 MHz to 2480 MHz		67		dBm
		f = 2500 MHz to 2700 MHz		62		dBm

Parameter	Symbol	Test Conditions/Comments	Min	Typ	Max	Unit		
RFC to Rx		f = 1805 MHz to 1910 MHz		33		dBm		
		f = 2010 MHz to 2025 MHz		32		dBm		
		f = 2300 MHz to 2480 MHz		33		dBm		
		f = 2500 MHz to 2700 MHz		32		dBm		
Input Third-Order Intercept, $V_{CTL} = 0\text{ V}/5\text{ V}$ Tx to RFC	IP3	Two-tone input power = 19 dBm/tone, $\Delta f = 1\text{ MHz}$						
		f = 1805 MHz to 1910 MHz		66		dBm		
		f = 2010 MHz to 2025 MHz		64		dBm		
		f = 2300 MHz to 2480 MHz		67		dBm		
RFC to Rx		f = 2500 MHz to 2700 MHz		62		dBm		
		f = 1805 MHz to 1910 MHz		44		dBm		
		f = 2010 MHz to 2025 MHz		45		dBm		
		f = 2300 MHz to 2480 MHz		45		dBm		
RFC to Rx		f = 2500 MHz to 2700 MHz		43		dBm		
		SWITCHING CHARACTERISTICS						
		Rise and Fall Time t_{RISE}, t_{FALL}	t_{RISE}, t_{FALL}	10% to 90% of RF output		21		ns
		On Time	t_{ON}	50% V_{CTL} to 90% of RF output		102		ns
Off Time	t_{OFF}	50% V_{CTL} to 10% of RF output		36		ns		

ABSOLUTE MAXIMUM RATINGS

Table 2.

Parameter	Rating
Supply Voltage (V_{DD})	10 V
Control Voltage Range (V_{CTL})	-0.2 V to V_{DD} to +1 V
RF Input Power, CW peak ¹	
Tx Port, $V_{DD} = 3$ V and $V_{DD} = 5$ V	40 dBm
Rx Port, $V_{DD} = 3$ V	24 dBm
Rx Port, $V_{DD} = 5$ V	29 dBm
Hot Switch	24 dBm
Continuous Power Dissipation (P_{DISS})	
Tx Port, $V_{DD} = 3$ V and $V_{DD} = 5$ V	1.12 W
Rx Port, $V_{DD} = 3$ V	73 mW
Rx Port, $V_{DD} = 5$ V	232 mW
Junction to Case Thermal Resistance, θ_{JC}	
Tx Port, $V_{DD} = 3$ V and $V_{DD} = 5$ V	54°C/W
Rx Port, $V_{DD} = 3$ V	68°C/W
Rx Port, $V_{DD} = 5$ V	86°C/W
Temperature	
Junction, T_J	150°C
Storage	-65°C to +150°C
Reflow (MSL1 Rating)	260°C
ESD Sensitivity	
Human Body Model (HBM)	250 V (Class 1A)

¹ Maximum input power can be higher when the radio frequency (RF) input is pulsed with a duty cycle <100%.

Stresses at or above those listed under Absolute Maximum Ratings may cause permanent damage to the product. This is a stress rating only; functional operation of the product at these or any other conditions above those indicated in the operational section of this specification is not implied. Operation beyond the maximum operating conditions for extended periods may affect product reliability.

ESD CAUTION



ESD (electrostatic discharge) sensitive device. Charged devices and circuit boards can discharge without detection. Although this product features patented or proprietary protection circuitry, damage may occur on devices subjected to high energy ESD. Therefore, proper ESD precautions should be taken to avoid performance degradation or loss of functionality.

PIN CONFIGURATION AND FUNCTION DESCRIPTIONS

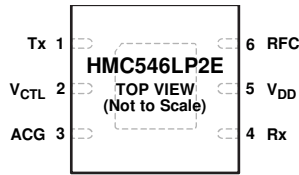

NOTES
 1. EXPOSED PAD. THE PACKAGE BOTTOM HAS AN EXPOSED METAL PADDLE THAT MUST BE CONNECTED TO THE PRINTED CIRCUIT BOARD (PCB) RF GROUND.

13975-002

Figure 2. Pin Configuration

Table 3. Pin Function Descriptions

Pin No.	Mnemonic	Description
1	Tx	Radio Frequency (RF) Transmit. This pin is dc-coupled and not well matched to 50 Ω. External matching components and a dc blocking capacitor are required.
2	V _{CTL}	Control Voltage Input. For more information about the V _{CTL} pin, see Table 4 and Figure 3.
3	ACG	AC Ground. An external capacitor from ACG to ground is required.
4	Rx	RF Receive. This pin is dc-coupled and not well matched to 50 Ω. External matching components and a dc blocking capacitor are required.
5	V _{DD}	Supply Voltage. See Figure 4 for the interface schematic.
6	RFC	RF Common. This pin is dc-coupled and not well matched to 50 Ω. External matching components and a dc blocking capacitor are required.
	EPAD	Exposed Pad. The package bottom has an exposed metal paddle that must be connected to the printed circuit board (PCB) RF ground.

Table 4. Truth Table

Control Input ¹		Signal Path State	
V _{CTL}	V _{DD}	RFC to Tx	RFC to Rx
0V	V _{DD}	Off	On
V _{DD}	V _{DD}	On	Off
0V	0V	On	Off
High-Z	High-Z	On	Off

¹ V_{DD} = 3 V to 8 V, and control input voltage tolerances are ±0.2 V dc.

INTERFACE SCHEMATICS

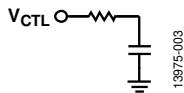

Figure 3. V_{CTL} Interface

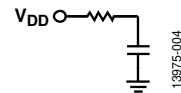

Figure 4. V_{DD} Interface

TYPICAL PERFORMANCE CHARACTERISTICS

1843 MHz TUNING

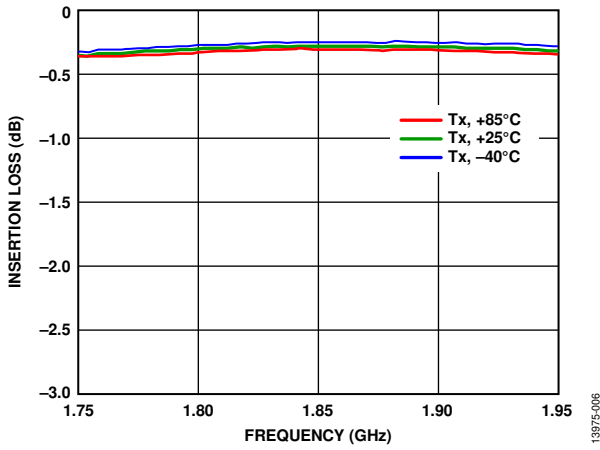

Figure 5. Tx to RFC Insertion Loss vs. Frequency over Temperature

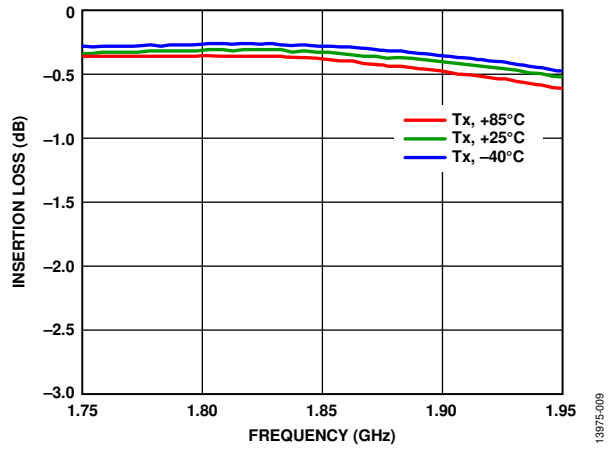

Figure 8. RFC to Rx Insertion Loss vs. Frequency over Temperature

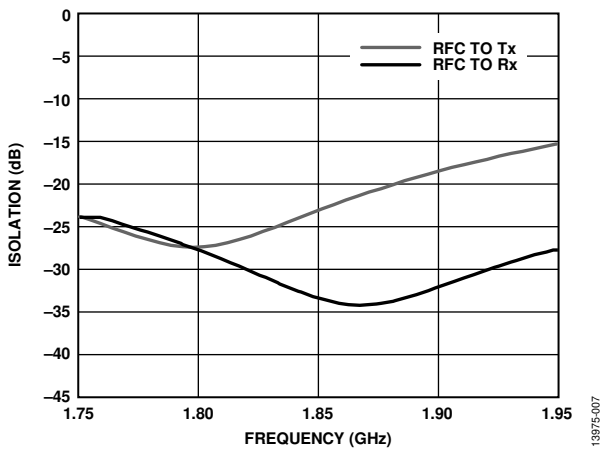

Figure 6. Isolation vs. Frequency

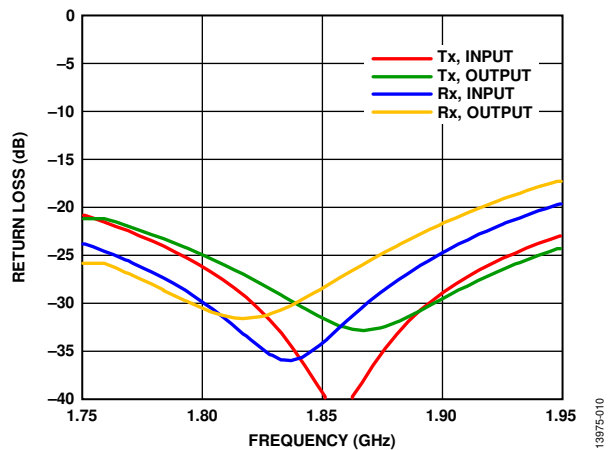

Figure 9. Return Loss vs. Frequency

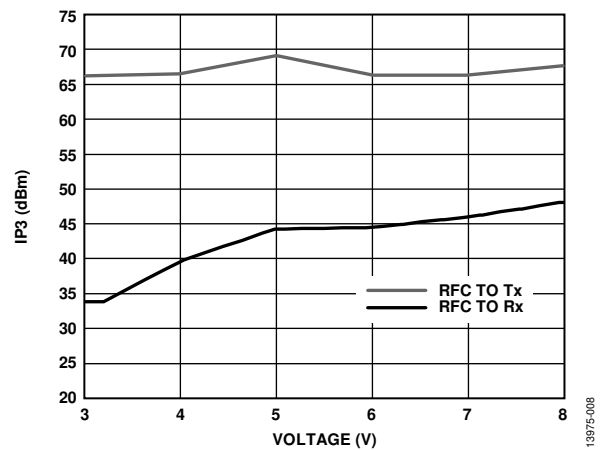

Figure 7. Input IP3 vs. Voltage

2015 MHZ TUNING

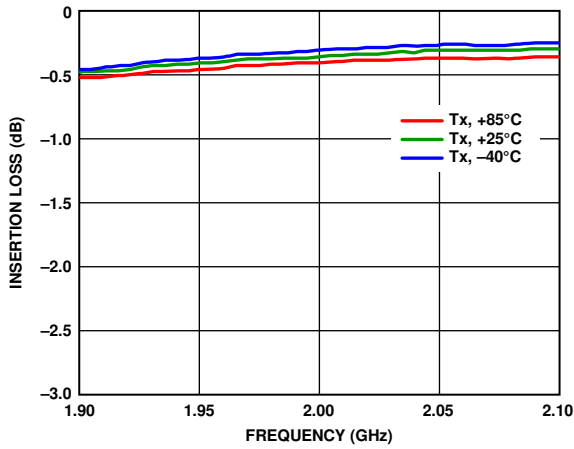

Figure 10. Tx to RFC Insertion Loss vs. Frequency over Temperature

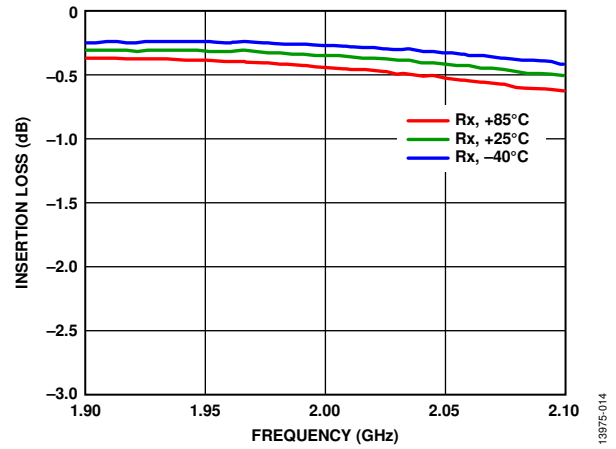

Figure 13. RFC to Rx Insertion Loss vs. Frequency over Temperature

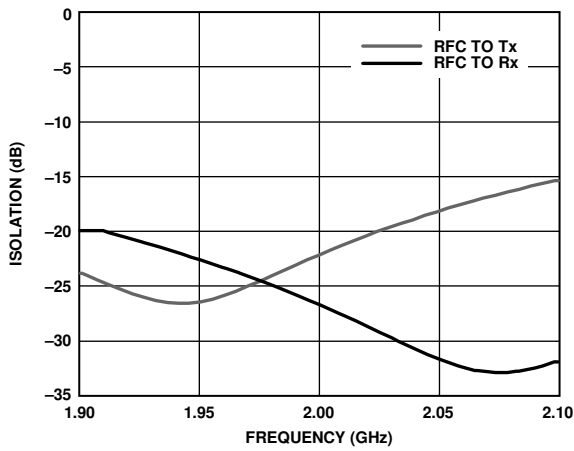

Figure 11. Isolation vs. Frequency

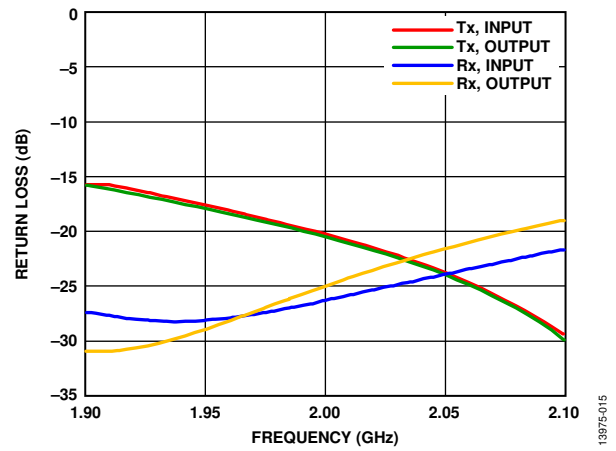

Figure 14. Return Loss vs. Frequency

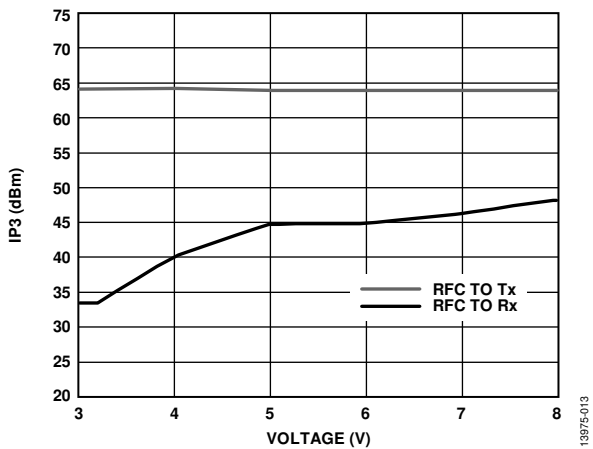

Figure 12. Input IP3 vs. Voltage

13975-011

13975-014

13975-012

13975-015

13975-013

2350 MHZ TUNING

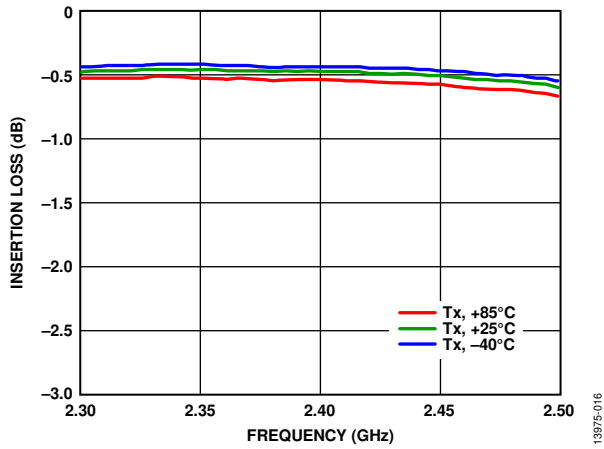

Figure 15. Tx to RFC Insertion Loss vs. Frequency over Temperature

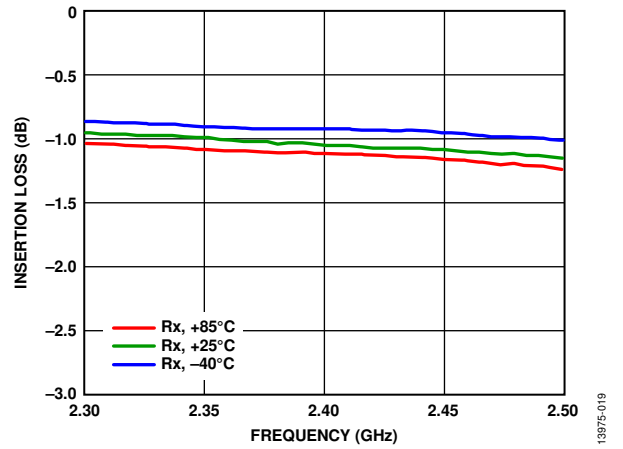

Figure 18. RFC to Rx Insertion Loss vs. Frequency over Temperature

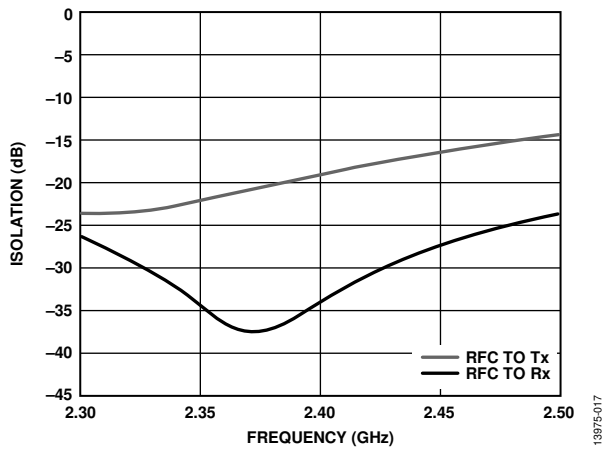

Figure 16. Isolation vs. Frequency

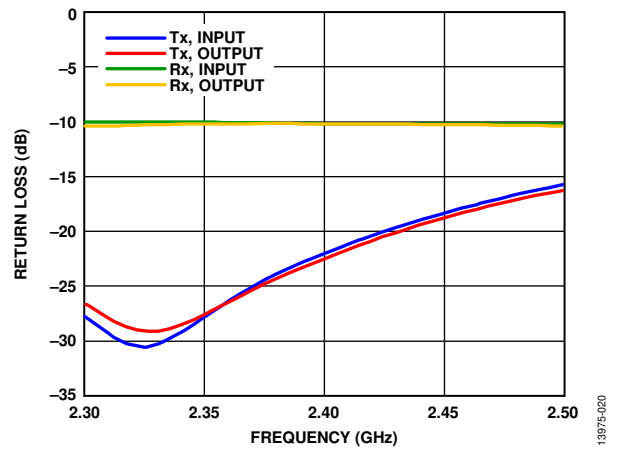

Figure 19. Return Loss vs. Frequency

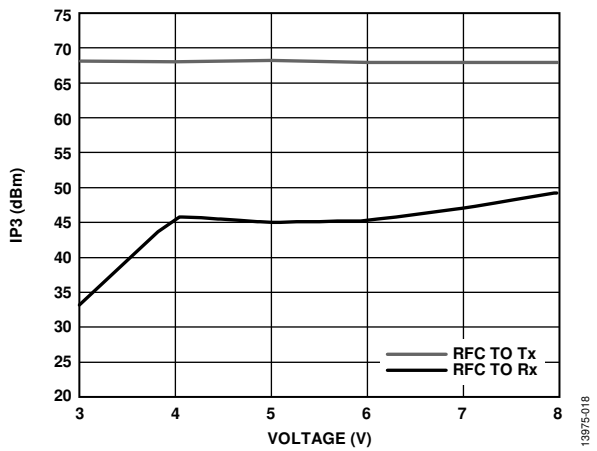

Figure 17. Input IP3 vs. Voltage

13975-016

13975-019

13975-017

13975-020

13975-018

2600 MHz TUNING

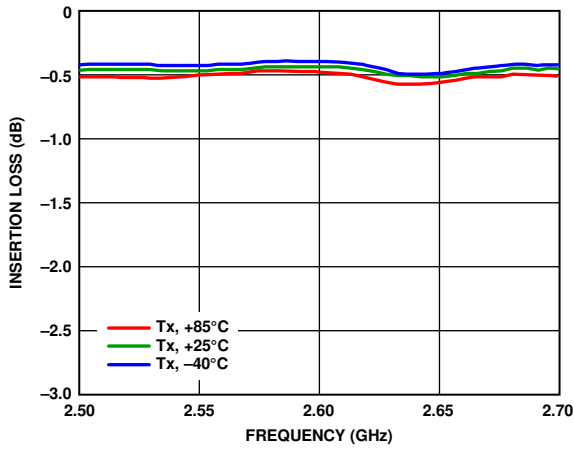

Figure 20. Tx to RFC Insertion Loss vs. Frequency over Temperature

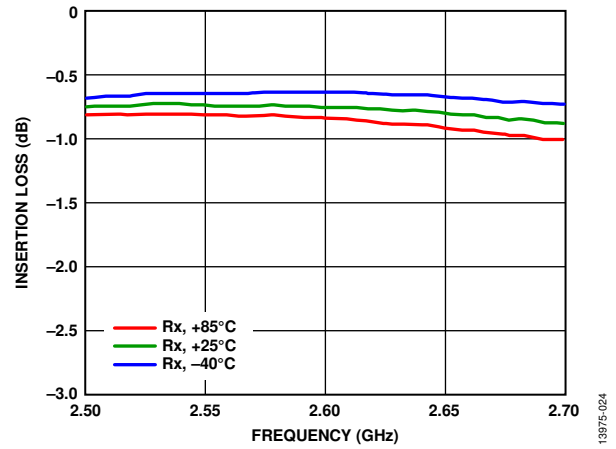

Figure 23. RFC to Rx Insertion Loss vs. Frequency over Temperature

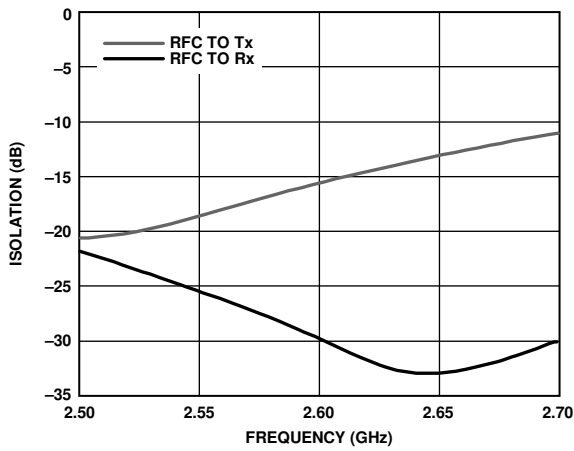

Figure 21. Isolation vs. Frequency

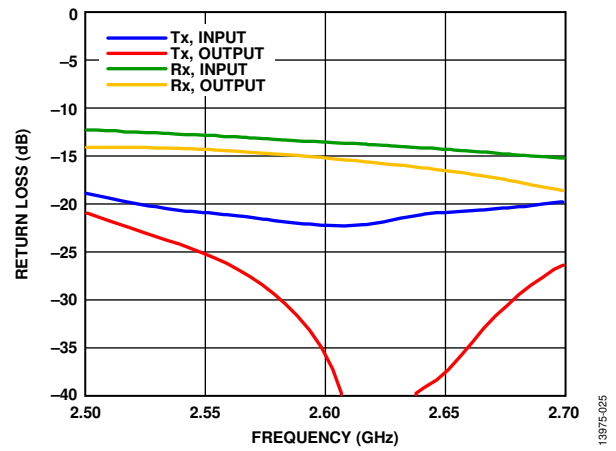

Figure 24. Return Loss vs. Frequency

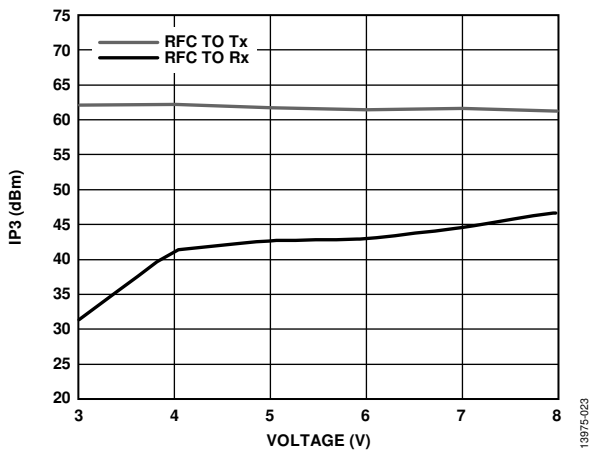

Figure 22. Input IP3 vs. Voltage

13975-021

13975-024

13975-022

13975-025

13975-023

APPLICATIONS INFORMATION

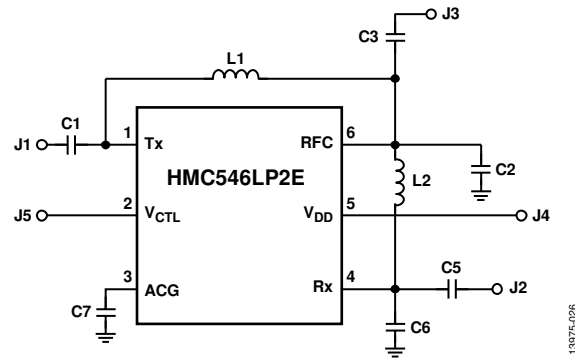

Figure 25. Applications Circuit

COMPONENTS FOR SELECTED FREQUENCIES

Table 5. Evaluation Board Components by Frequency

Component	Tuned Frequency ¹			
	1843 MHz	2015 MHz	2350 MHz	2600 MHz
C1, C3, C5 ²	330 pF	330 pF	330 pF	330 pF
C2	1.2 pF	0.8 pF	0.6 pF	0.7 pF
C6	0.5 pF	N/A	N/A	N/A
C7	3.0 pF	2.4 pF	2.0 pF	1.5 pF
L1 ^{3, 4}	5.1 nH	4.3 nH	2.0 nH	1.6 nH
L2 ⁵	4.3 nH	3.9 nH	3.3 nH	2.7 nH

¹ N/A means not applicable.² DC blocking capacitors.³ 0402 inductors, 5% tolerance; for tuned frequencies of 1843 MHz, 2015 MHz, and 2350 MHz.⁴ 0603 inductor, 5% tolerance; for tuned frequency of 2600 MHz only.⁵ 0402 inductor, 5% tolerance; for all tuned frequency levels.

EVALUATION PCB

When using the circuit board in an application, generate proper RF circuit design techniques. Ensure that signal lines have 50 Ω impedance and that the package ground leads and exposed paddle are connected directly to the ground plane, as shown in Figure 26. The evaluation circuit board shown in Figure 26 is available from Analog Devices, Inc., upon request.

Bill of Materials

Table 6. Bill of Materials¹

Item ²	Description
J1 to J3	PCB mount SMA RF connector
J4 to J6	DC pins
C1 to C3	Capacitors, 0402 package
L1, L2	Inductors
U1	HMC546LP2E transmit/receive switches
PCB ³	110780 evaluation PCB

¹ When requesting an evaluation board, reference the appropriate evaluation PCB number listed in the Ordering Guide section.

² Refer to Table 5 for component values.

³ Circuit board material: Rogers 4350.

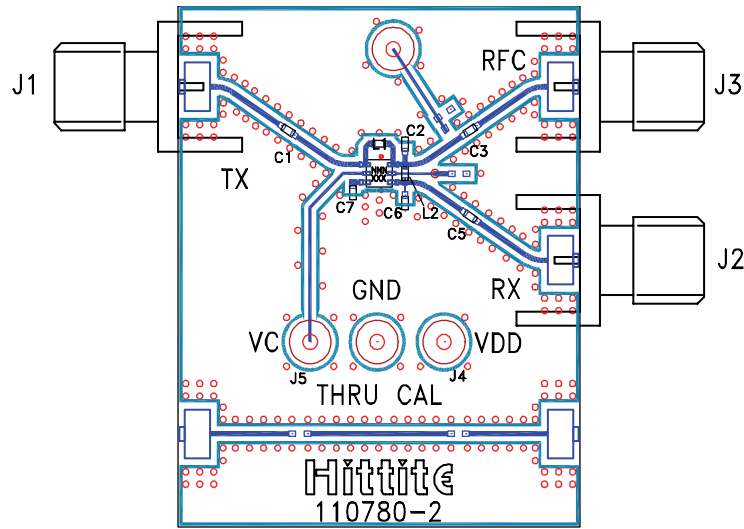

Figure 26. Evaluation Printed Circuit Board (PCB)

OUTLINE DIMENSIONS

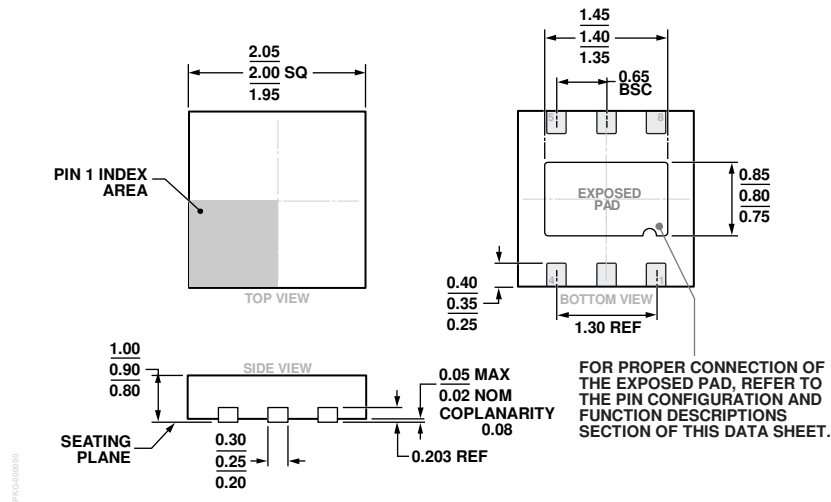

Figure 27. 6-Lead Lead Frame Chip Scale Package [LFCSP]
2 mm x 2mm Body and 0.90 mm Package Height
(CP-6-10)

Dimensions shown in millimeters

ORDERING GUIDE

Model ¹	Temperature Range	MSL Rating ²	Package Description	Package Option	Package Marking ³
HMC546LP2E	-40°C to +85°C	MSL1	6-Lead Lead Frame Chip Scale Package [LFCSP]	CP-6-10	546 XXXX
HMC546LP2ETR	-40°C to +85°C	MSL1	6-Lead Lead Frame Chip Scale Package [LFCSP]	CP-6-10	546 XXXX
110782-HMC546LP2			Evaluation Board, 1843 MHz Tune		
115201-HMC546LP2			Evaluation Board, 2015 MHz Tune		
115202-HMC546LP2			Evaluation Board, 2350 MHz Tune		
115203-HMC546LP2			Evaluation Board, 2600 MHz Tune		

¹ HMC546LP2E and HMC546LP2ETR are RoHS compliant parts.

² See the Absolute Maximum Ratings section.

³ XXXX is the 4-digit lot number.