



Chipsmall Limited consists of a professional team with an average of over 10 year of expertise in the distribution of electronic components. Based in Hongkong, we have already established firm and mutual-benefit business relationships with customers from,Europe,America and south Asia,supplying obsolete and hard-to-find components to meet their specific needs.

With the principle of “Quality Parts,Customers Priority,Honest Operation,and Considerate Service”,our business mainly focus on the distribution of electronic components. Line cards we deal with include Microchip,ALPS,ROHM,Xilinx,Pulse,ON,Everlight and Freescale. Main products comprise IC,Modules,Potentiometer,IC Socket,Relay,Connector.Our parts cover such applications as commercial,industrial, and automotives areas.

We are looking forward to setting up business relationship with you and hope to provide you with the best service and solution. Let us make a better world for our industry!



Contact us

Tel: +86-755-8981 8866 Fax: +86-755-8427 6832

Email & Skype: info@chipsmall.com Web: www.chipsmall.com

Address: A1208, Overseas Decoration Building, #122 Zhenhua RD., Futian, Shenzhen, China





GaAs pHEMT MMIC LNA, 75 Ohm 50 - 1000 MHz

Typical Applications

The HMC599ST89(E) is ideal for:

- VHF / UHF Antennas
- HDTV Receivers
- CMTS Equipment
- CATV, Cable Modem & DBS

Features

- High P1dB Output Power: +19 dBm
- High Output IP3: +39 dBm
- Low Noise Figure: 2.2 dB
- Cascadable 75 Ohm I/Os
- Single Bias Supply: +3V or +5V
- Industry Standard SOT89 Package

Functional Diagram

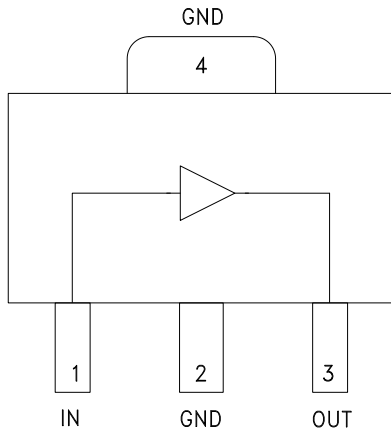

General Description

The HMC599ST89(E) is a GaAs PHEMT High Linearity, Low Noise Gain Block MMIC SMT amplifier covering 50 to 1000 MHz. Packaged in an industry standard SOT89, the amplifier can be used as a cascadable 75 Ohm RF or IF gain stage as well as a PA or LO driver with up to +19 dBm output power. The HMC599ST89(E) offers 14 dB of gain with a +39 dBm output IP3 at 250 MHz, and can operate directly from a +3V or +5V supply. The HMC599ST89(E) exhibits excellent gain and output power stability over temperature, while requiring a minimal number of external bias components.

Electrical Specifications, $V_{dd} = 5V$, $T_A = +25^\circ C$

Parameter	Min.	Typ.	Max.	Units	
Gain	50 - 500 MHz	13	14.5	dB	
	500 - 1000 MHz	12	14	dB	
Gain Variation Over Temperature	50 - 1000 MHz		0.005	dB/ °C	
Input Return Loss	50 - 500 MHz		15	dB	
	500 - 1000 MHz		12	dB	
Output Return Loss	50 - 500 MHz		25	dB	
	500 - 1000 MHz		15	dB	
Reverse Isolation	50 - 1000 MHz		20	dB	
Output Power for 1 dB Compression (P1dB)	50 - 500 MHz	16	19	dBm	
Output Third Order Intercept (IP3) (Pout= -10 dBm per tone, 1 MHz spacing)	50 - 500 MHz		39	dBm	
	500 - 1000 MHz		36	dBm	
Noise Figure	50 - 1000 MHz		2.2	dB	
Supply Current (Idd)		100	120	140	mA

Information furnished by Analog Devices is believed to be accurate and reliable. However, no responsibility is assumed by Analog Devices for its use, nor for any infringements of patents or other rights of third parties that may result from its use. Specifications subject to change without notice. No license is granted by implication or otherwise under any patent or patent rights of Analog Devices. Trademarks and registered trademarks are the property of their respective owners.

For price, delivery, and to place orders: Analog Devices, Inc., One Technology Way, P.O. Box 9106, Norwood, MA 02062-9106
Phone: 781-329-4700 • Order online at www.analog.com
Application Support: Phone: 1-800-ANALOG-D

HMC599* PRODUCT PAGE QUICK LINKS

Last Content Update: 02/23/2017

COMPARABLE PARTS

View a parametric search of comparable parts.

EVALUATION KITS

- HMC599ST89 Evaluation Board

DOCUMENTATION

Application Notes

- AN-1363: Meeting Biasing Requirements of Externally Biased RF/Microwave Amplifiers with Active Bias Controllers
- Broadband Biasing of Amplifiers General Application Note
- MMIC Amplifier Biasing Procedure Application Note
- Thermal Management for Surface Mount Components General Application Note

Data Sheet

- HMC599 Data Sheet

REFERENCE MATERIALS

Quality Documentation

- Package/Assembly Qualification Test Report: 3 Lead Plastic SOT89 Package (QTR: 10002 REV: 02)
- Semiconductor Qualification Test Report: PHEMT-G (QTR: 2013-00273)

DESIGN RESOURCES

- HMC599 Material Declaration
- PCN-PDN Information
- Quality And Reliability
- Symbols and Footprints

DISCUSSIONS

View all HMC599 EngineerZone Discussions.

SAMPLE AND BUY

Visit the product page to see pricing options.

TECHNICAL SUPPORT

Submit a technical question or find your regional support number.

DOCUMENT FEEDBACK

Submit feedback for this data sheet.



Broadband Gain & Return Loss @ 3V

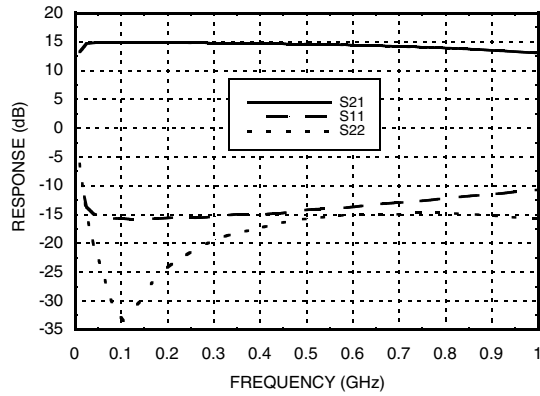

Broadband Gain & Return Loss @ 5V

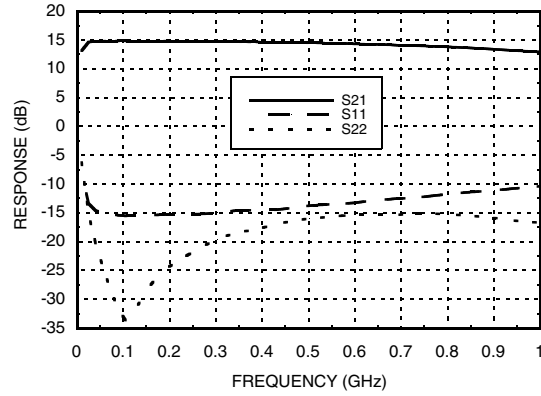

Gain vs. Temperature @ 3V

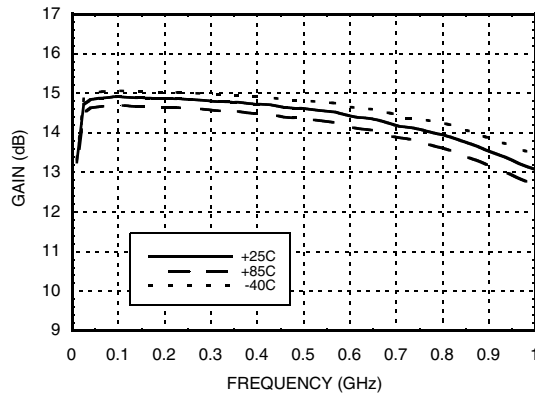

Gain vs. Temperature @ 5V

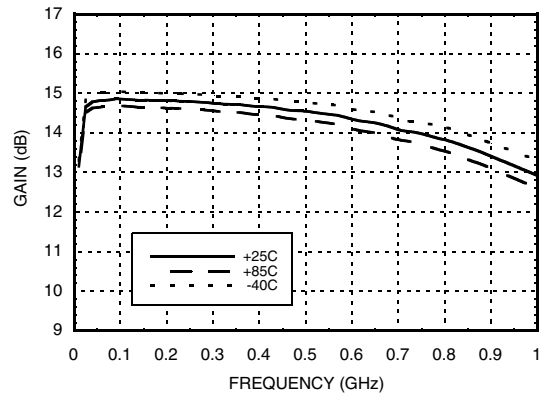

Input Return Loss vs. Temperature @ 3V

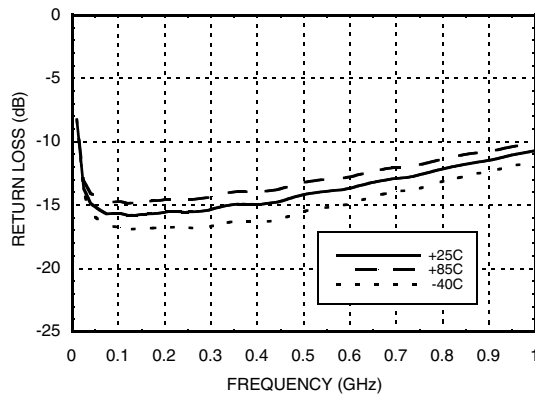

Input Return Loss vs. Temperature @ 5V

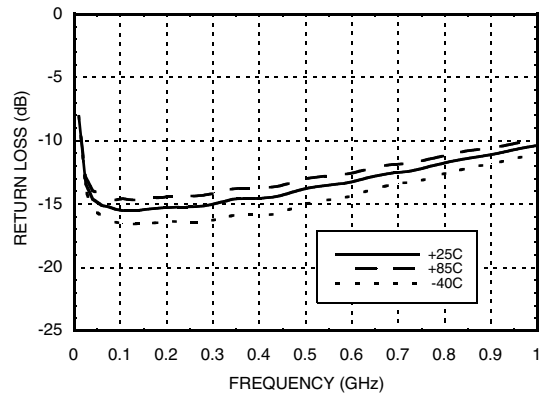

Information furnished by Analog Devices is believed to be accurate and reliable. However, no responsibility is assumed by Analog Devices for its use, nor for any infringements of patents or other rights of third parties that may result from its use. Specifications subject to change without notice. No license is granted by implication or otherwise under any patent or patent rights of Analog Devices. Trademarks and registered trademarks are the property of their respective owners.

For price, delivery, and to place orders: Analog Devices, Inc., One Technology Way, P.O. Box 9106, Norwood, MA 02062-9106 Phone: 781-329-4700 • Order online at www.analog.com Application Support: Phone: 1-800-ANALOG-D



Output Return Loss vs. Temperature @ 3V

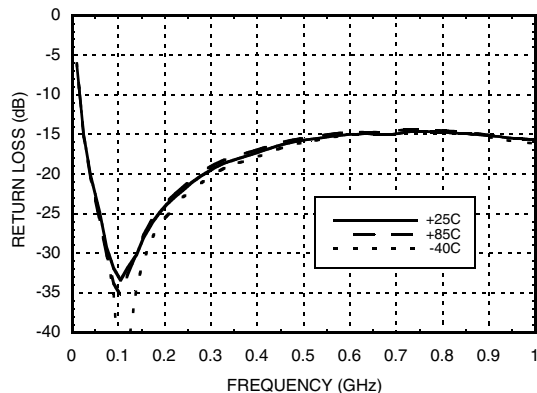

Output Return Loss vs. Temperature @ 5V

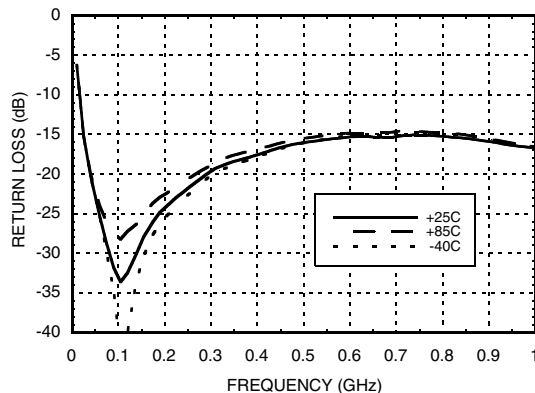

Reverse Isolation vs. Temperature @ 3V

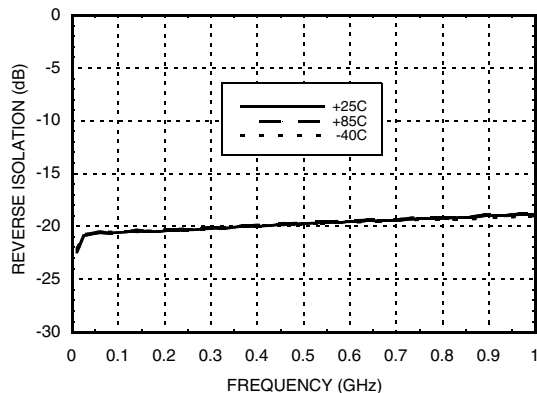

Reverse Isolation vs. Temperature @ 5V

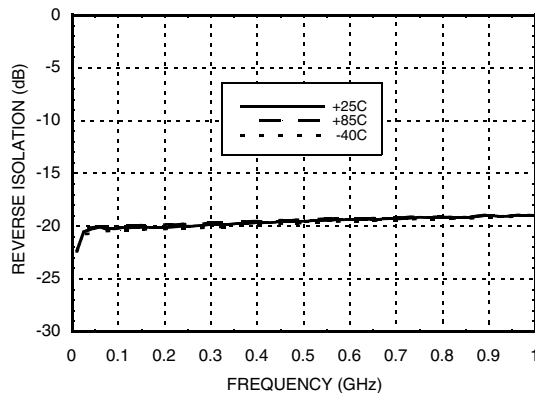

Noise Figure vs. Temperature @ 3V

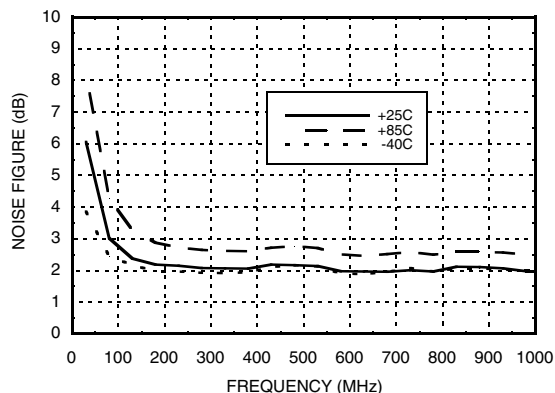

Noise Figure vs. Temperature @ 5V

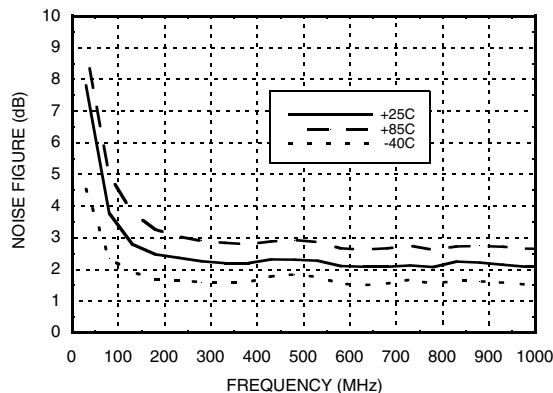

Information furnished by Analog Devices is believed to be accurate and reliable. However, no responsibility is assumed by Analog Devices for its use, nor for any infringements of patents or other rights of third parties that may result from its use. Specifications subject to change without notice. No license is granted by implication or otherwise under any patent or patent rights of Analog Devices. Trademarks and registered trademarks are the property of their respective owners.

For price, delivery, and to place orders: Analog Devices, Inc., One Technology Way, P.O. Box 9106, Norwood, MA 02062-9106 Phone: 781-329-4700 • Order online at www.analog.com Application Support: Phone: 1-800-ANALOG-D



IP3 vs. Temperature @ 3V

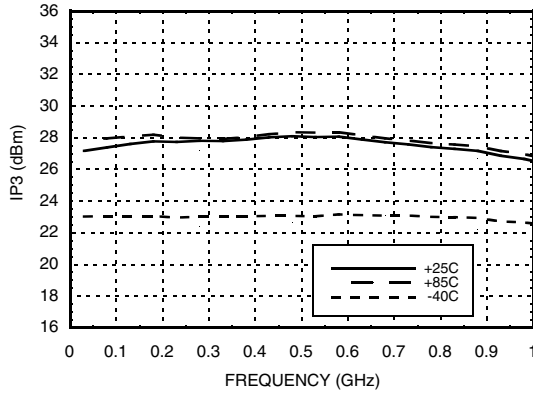

IP3 vs. Temperature @ 5V

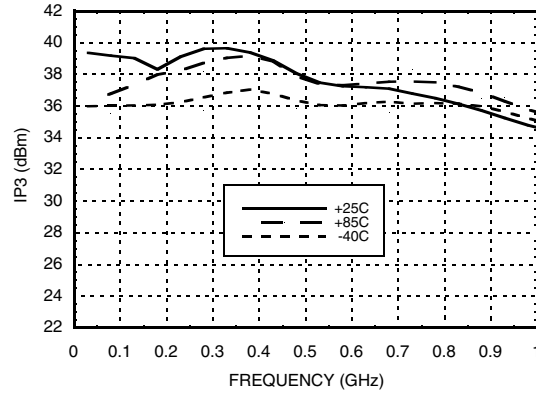

P1dB vs. Temperature @ 3V

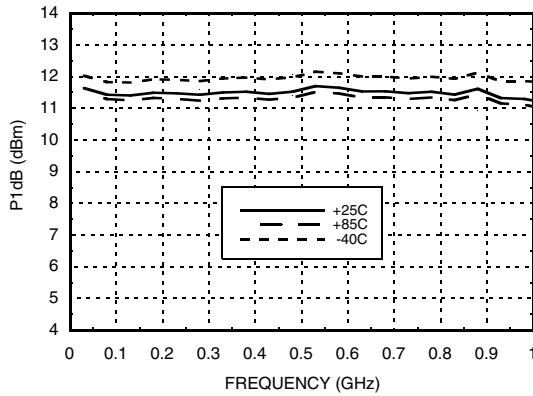

P1dB vs. Temperature @ 5V

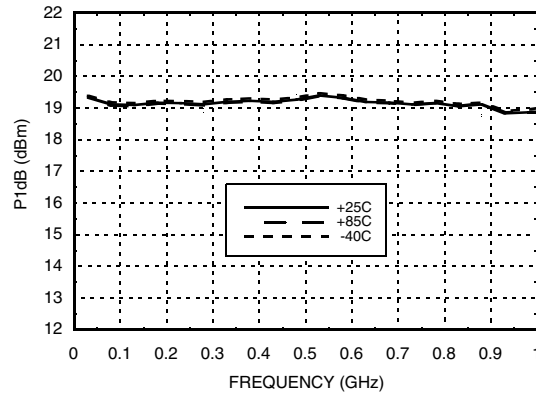

Psat vs. Temperature @ 3V

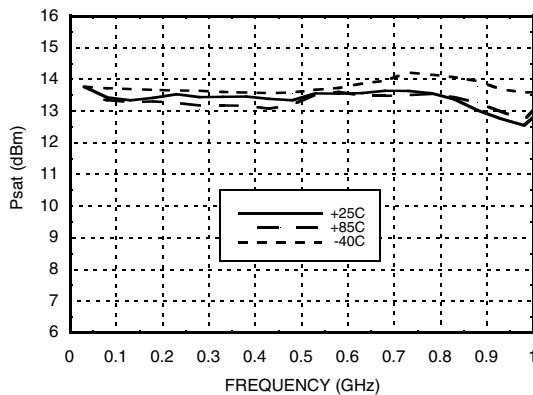

Psat vs. Temperature @ 5V

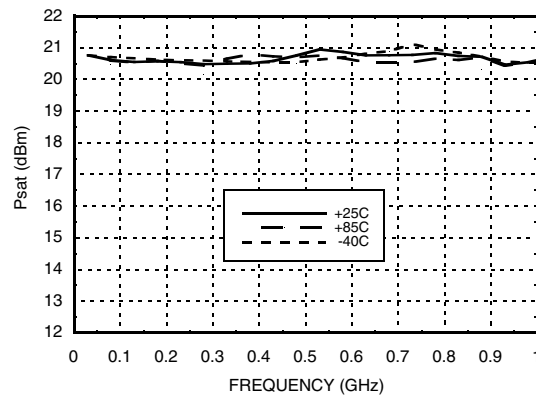

Information furnished by Analog Devices is believed to be accurate and reliable. However, no responsibility is assumed by Analog Devices for its use, nor for any infringements of patents or other rights of third parties that may result from its use. Specifications subject to change without notice. No license is granted by implication or otherwise under any patent or patent rights of Analog Devices. Trademarks and registered trademarks are the property of their respective owners.

For price, delivery, and to place orders: Analog Devices, Inc., One Technology Way, P.O. Box 9106, Norwood, MA 02062-9106 Phone: 781-329-4700 • Order online at www.analog.com Application Support: Phone: 1-800-ANALOG-D



Gain vs. Supply Voltage

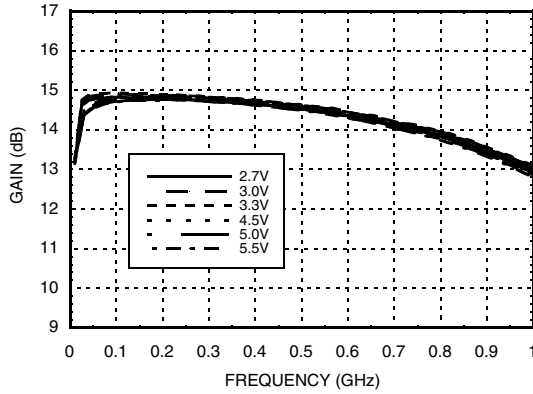

Noise Figure vs. Supply Voltage

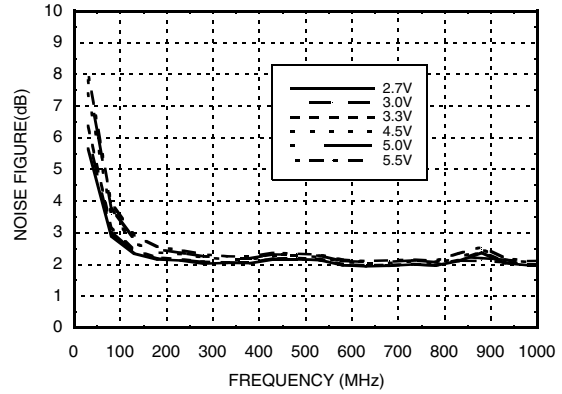

IP3 vs. Supply Voltage

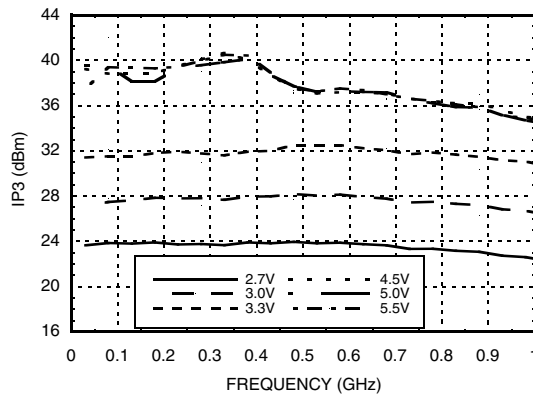

P1dB vs. Supply Voltage

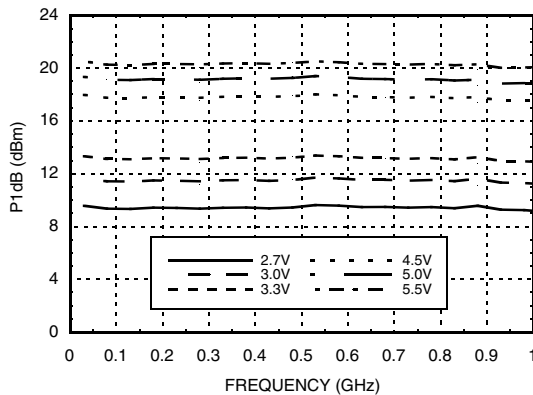

Psat vs. Supply Voltage

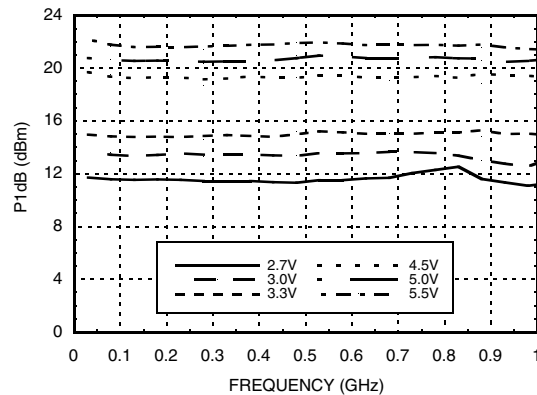

Information furnished by Analog Devices is believed to be accurate and reliable. However, no responsibility is assumed by Analog Devices for its use, nor for any infringements of patents or other rights of third parties that may result from its use. Specifications subject to change without notice. No license is granted by implication or otherwise under any patent or patent rights of Analog Devices. Trademarks and registered trademarks are the property of their respective owners.

For price, delivery, and to place orders: Analog Devices, Inc., One Technology Way, P.O. Box 9106, Norwood, MA 02062-9106 Phone: 781-329-4700 • Order online at www.analog.com Application Support: Phone: 1-800-ANALOG-D



Absolute Maximum Ratings

Drain Bias Voltage (Vdd)	+6 Vdc
RF Input Power (RFIN)	+10 dBm
Channel Temperature	175 °C
Continuous Pdiss (T = 85 °C) (derate 9.84 mW/°C above 85 °C)	0.89 W
Thermal Resistance (junction to ground paddle)	101.67 °C/W
Storage Temperature	-65 to +150 °C
Operating Temperature	-40 to +85 °C

Typical Supply Current vs. Vdd

Vdd (Vdc)	Idd (mA)
+5	120
+3	120



ELECTROSTATIC SENSITIVE DEVICE
OBSERVE HANDLING PRECAUTIONS

Outline Drawing

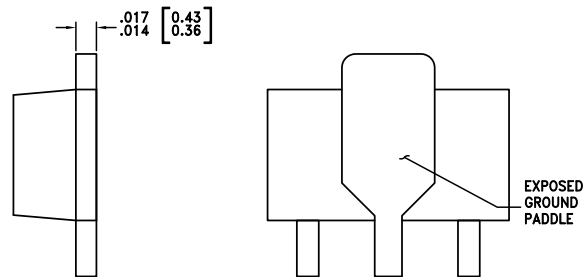
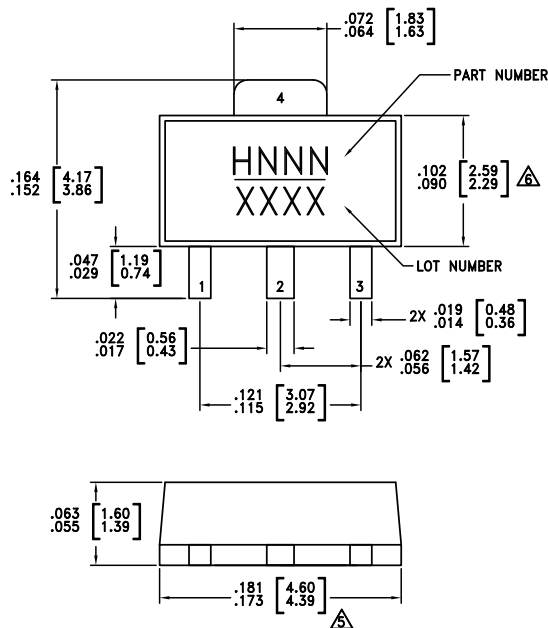

NOTES:

- PACKAGE BODY MATERIAL:
MOLDING COMPOUND MP-180S OR EQUIVALENT.
- LEAD MATERIAL: Cu w/ Ag SPOT PLATING.
- LEAD PLATING: 100% MATTE TIN.
- DIMENSIONS ARE IN INCHES [MILLIMETERS]
- Δ DIMENSION DOES NOT INCLUDE MOLDFLASH OF 0.15 mm PER SIDE.
- ∇ DIMENSION DOES NOT INCLUDE MOLDFLASH OF 0.25 mm PER SIDE.
- ALL GROUND LEADS MUST BE SOLDERED TO PCB RF GROUND.

Package Information

Part Number	Package Body Material	Lead Finish	MSL Rating	Package Marking ^[3]
HMC599ST89	Low Stress Injection Molded Plastic	Sn/Pb Solder	MSL1 ^[1]	H599 XXXX
HMC599ST89E	RoHS-compliant Low Stress Injection Molded Plastic	100% matte Sn	MSL1 ^[2]	<u>H599</u> XXXX

[1] Max peak reflow temperature of 235 °C

[2] Max peak reflow temperature of 260 °C

[3] 4-Digit lot number XXXX



Pin Descriptions

Pin Number	Function	Description	Interface Schematic
1	IN	This pin is DC coupled. See the application circuit for off-chip components	
3	OUT	RF output and DC Bias (Vdd) for the output stage.	
2, 4	GND	These pins and package bottom must be connected to RF/DC ground.	

Application Circuit

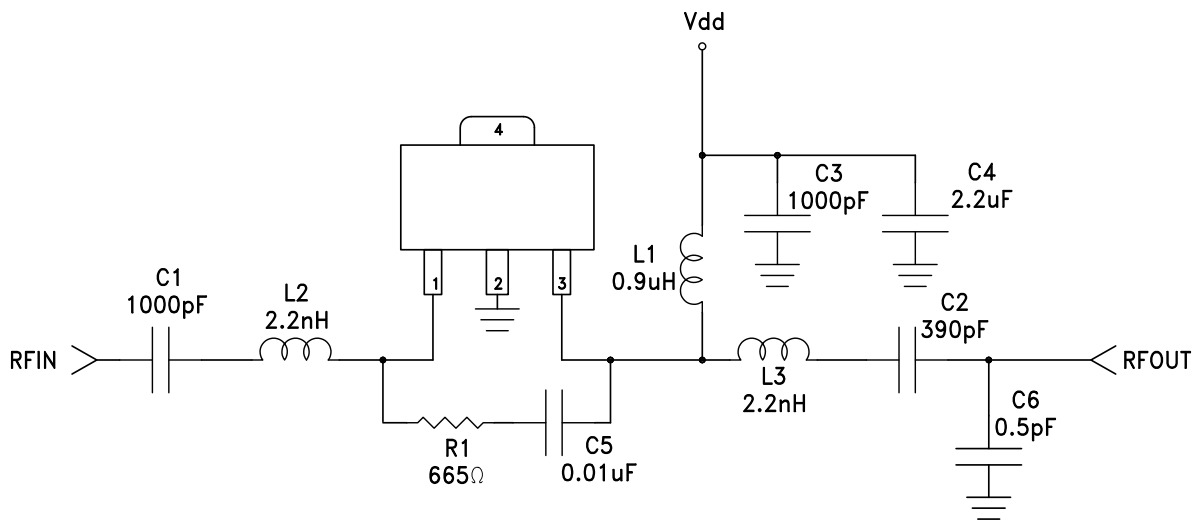

Information furnished by Analog Devices is believed to be accurate and reliable. However, no responsibility is assumed by Analog Devices for its use, nor for any infringements of patents or other rights of third parties that may result from its use. Specifications subject to change without notice. No license is granted by implication or otherwise under any patent or patent rights of Analog Devices. Trademarks and registered trademarks are the property of their respective owners.

For price, delivery, and to place orders: Analog Devices, Inc., One Technology Way, P.O. Box 9106, Norwood, MA 02062-9106 Phone: 781-329-4700 • Order online at www.analog.com Application Support: Phone: 1-800-ANALOG-D

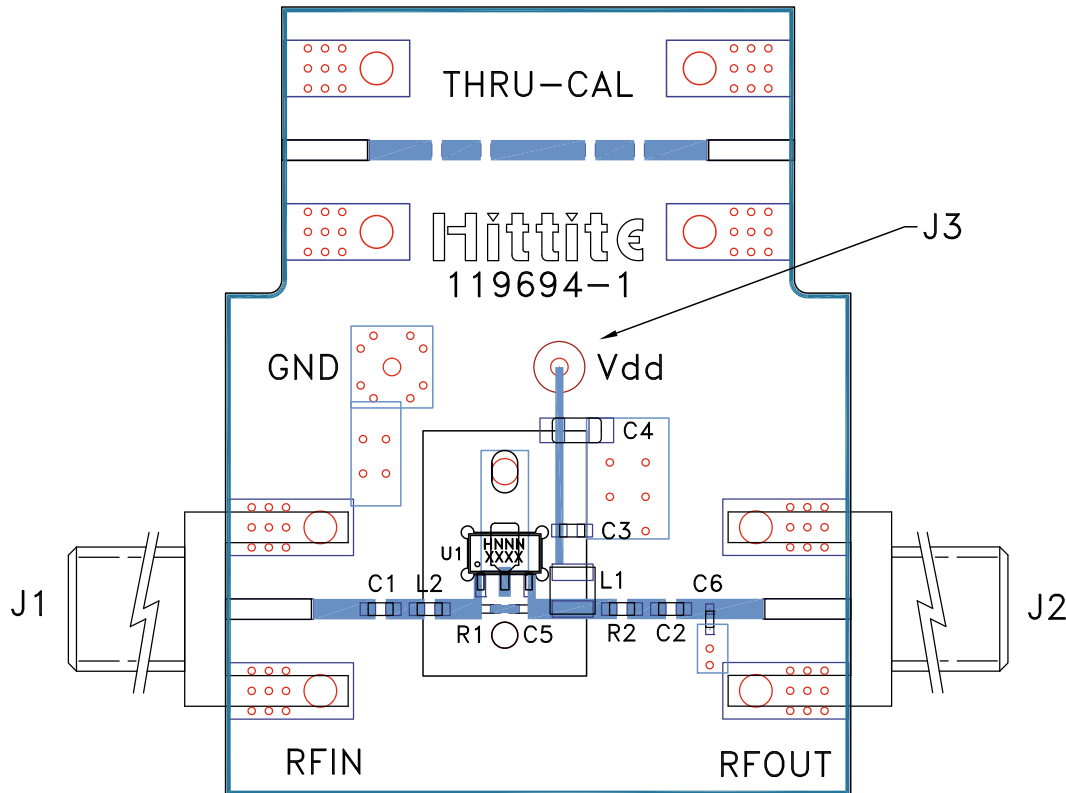
Evaluation PCB

List of Materials for Evaluation PCB 119696 [1]

Item	Description
J1 - J2	PCB Mount 75 Ohm Connector
J3	DC Pin
C1, C3	1000 pF Capacitor, 0603 Pkg.
C2	390 pF Capacitor, 0603 Pkg.
C4	2.2 μ F Capacitor, Tantalum
C5	10 KpF Capacitor, 0402 Pkg.
C6	0.5 pF Capacitor, 0402 Pkg.
L1	0.9 μ H Inductor, 1008 Pkg.
L2, L3	2.2 nH Inductor, 0603 Pkg.
R1	665 Ohm Resistor, 0402 Pkg.
U1	HMC599ST89 / HMC599ST89E
PCB [2]	119694 Evaluation PCB

[1] Reference this number when ordering complete evaluation PCB

[2] Circuit Board Material: Rogers 4350

[3] Evaluation board tuned for 900 MHz operation

The circuit board used in the application should use RF circuit design techniques. Signal lines should have 50 Ohm impedance while the package ground leads and package bottom should be connected directly to the ground plane similar to that shown. A sufficient number of via holes should be used to connect the top and bottom ground planes. The evaluation board should be mounted to an appropriate heat sink. The evaluation circuit board shown is available from Hittite upon request.