



Chipsmall Limited consists of a professional team with an average of over 10 year of expertise in the distribution of electronic components. Based in Hongkong, we have already established firm and mutual-benefit business relationships with customers from,Europe,America and south Asia,supplying obsolete and hard-to-find components to meet their specific needs.

With the principle of "Quality Parts,Customers Priority,Honest Operation,and Considerate Service",our business mainly focus on the distribution of electronic components. Line cards we deal with include Microchip,ALPS,ROHM,Xilinx,Pulse,ON,Everlight and Freescale. Main products comprise IC,Modules,Potentiometer,IC Socket,Relay,Connector.Our parts cover such applications as commercial,industrial, and automotives areas.

We are looking forward to setting up business relationship with you and hope to provide you with the best service and solution. Let us make a better world for our industry!



## Contact us

Tel: +86-755-8981 8866 Fax: +86-755-8427 6832

Email & Skype: info@chipsmall.com Web: www.chipsmall.com

Address: A1208, Overseas Decoration Building, #122 Zhenhua RD., Futian, Shenzhen, China





## GaAs MMIC MIXER w/ INTEGRATED LO AMPLIFIER, 2.3 - 4.0 GHz

### Typical Applications

The HMC615LP4E is ideal for:

- PCS / 3G Infrastructure
- Base Stations & Repeaters
- WiMAX & WiBro
- ISM & Fixed Wireless

### Features

- High Input IP3: +35 dBm
- Low Input LO Drive: -2 to +6 dBm
- Low Conversion Loss: 10 dB
- Single Positive Supply: +5V @ 65 mA
- 24 Lead 4x4mm QFN Package: 9 mm<sup>2</sup>

### Functional Diagram

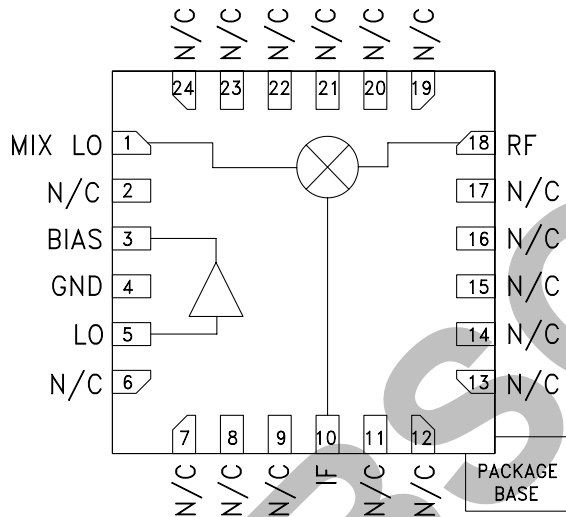

### General Description

The HMC615LP4(E) are high linearity, GaAs FET converter ICs that operate from 2.3 to 4.0 GHz and deliver a +35 dBm input third order intercept point. The LO amplifier output and high dynamic range mixer input are positioned so that an external LO filter can be placed in series between them. The IC operates from a single +5V supply consuming 65 mA of current and accepts a LO drive level of -2 to +6 dBm. The design requires no external baluns and supports IF frequencies between DC and 1 GHz. The HMC615LP4(E) is pin for pin compatible with the HMC551LP4(E), HMC552LP4(E) and HMC215LP4(E), which operate from 0.8 to 4.0 GHz. For availability on Non-RoHS HMC615LP4 products please contact Hittite Microwave sales directly.

### Electrical Specifications, $T_A = +25^\circ\text{C}$ , LO = 4 dBm, Vcc = +5V, R1 = 18 Ohms, IF = 200 MHz\*

Parameter	Min.	Typ.	Max.	Units
Frequency Range, RF, LO	2.3 - 4.0			GHz
Frequency Range, IF	DC - 1.0			GHz
Conversion Loss *		10	13	dB
Noise Figure (SSB)		10		dB
LO to RF Isolation	5	15		dB
LO to IF Isolation *	1	10		dB
IP3 (Input)		35		dBm
1 dB Compression (Input)		21		dBm
LO Drive Input Level (Typical)	-2 to +6			dBm
Supply Current (Icc)		65	75	mA

\*Unless otherwise noted, all measurements performed as a downconverter configured as shown in application circuit.



**GaAs MMIC MIXER w/ INTEGRATED LO AMPLIFIER, 2.3 - 4.0 GHz**

**Conversion Gain vs. Temperature @ LO = 4 dBm**

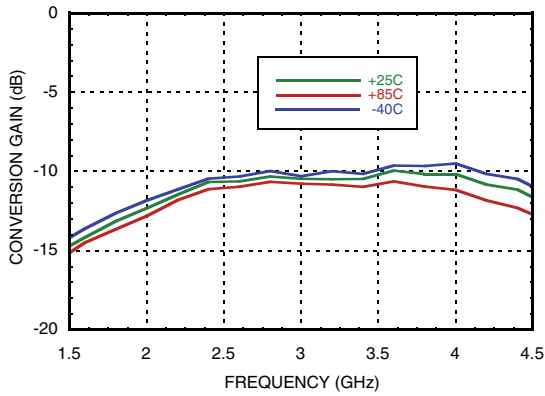

**Isolation @ LO = 4 dBm**

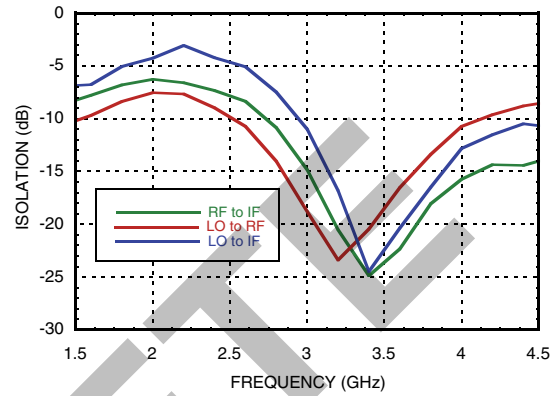

**Conversion Gain vs. LO Drive**

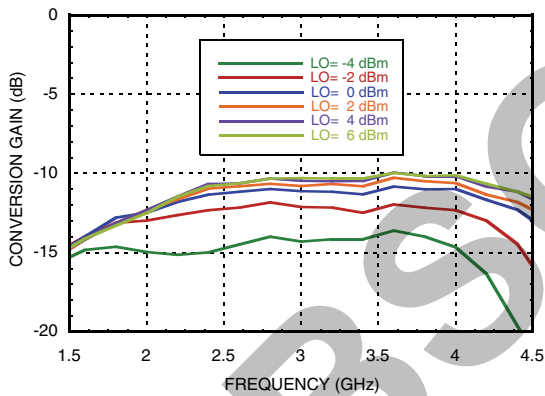

**Return Loss @ LO = 4 dBm**

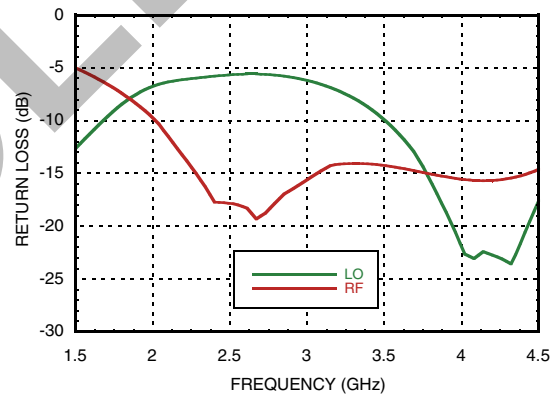

**Upconverter Performance (IF = 100 MHz) Conversion Gain vs. LO Drive**

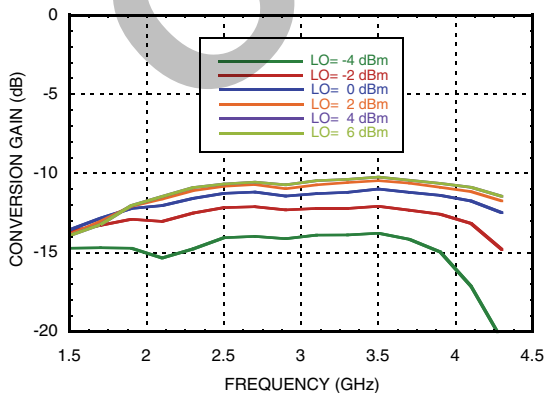

**IF Bandwidth @ LO = 4 dBm**

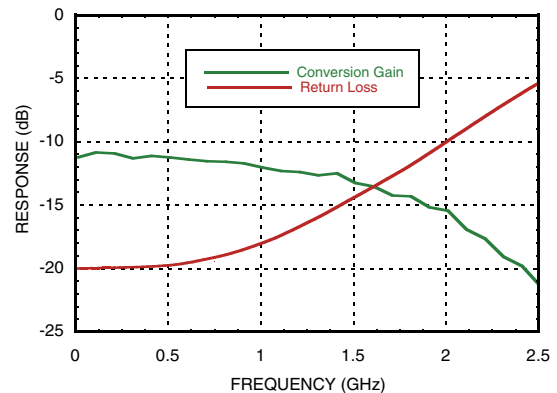

Information furnished by Analog Devices is believed to be accurate and reliable. However, no responsibility is assumed by Analog Devices for its use, nor for any infringements of patents or other rights of third parties that may result from its use. Specifications subject to change without notice. No license is granted by implication or otherwise under any patent or patent rights of Analog Devices. Trademarks and registered trademarks are the property of their respective owners.

For price, delivery, and to place orders: Analog Devices, Inc., One Technology Way, P.O. Box 9106, Norwood, MA 02062-9106 Phone: 781-329-4700 • Order online at [www.analog.com](http://www.analog.com) Application Support: Phone: 1-800-ANALOG-D



**GaAs MMIC MIXER w/ INTEGRATED LO AMPLIFIER, 2.3 - 4.0 GHz**

MIXERS - HIGH IP3 - SMT

**Input IP3 vs. Temperature @ LO = 4 dBm**

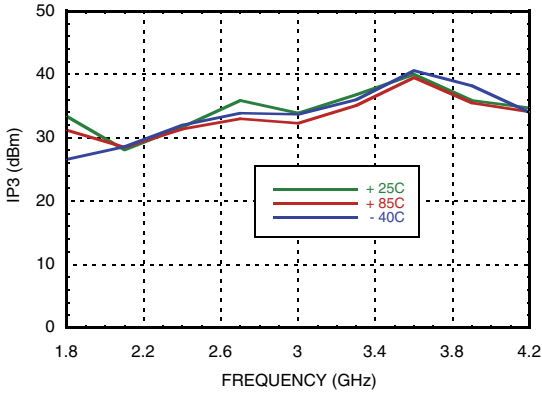

**Input IP3 vs. LO Drive**

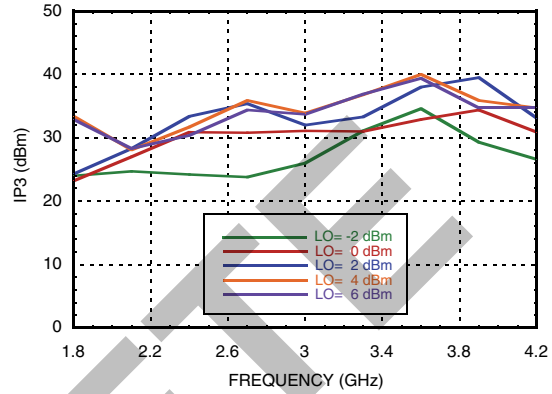

**Input IP2 vs. Temperature @ LO = 4 dBm**

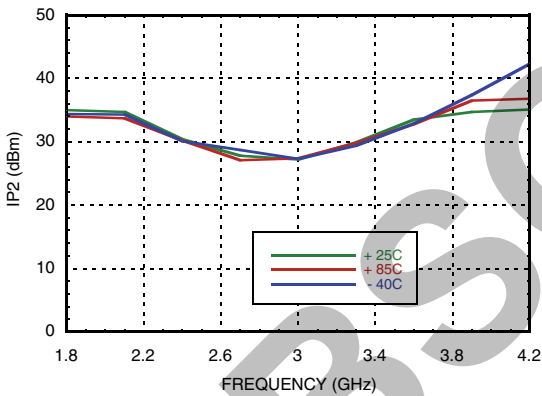

**Input IP2 vs. LO Drive**

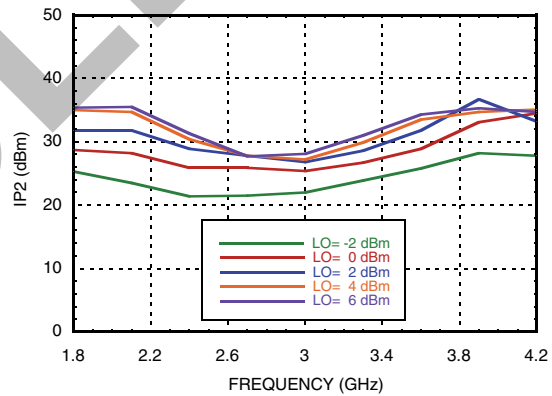

**Input P1dB vs. Temperature @ LO = 4 dBm**

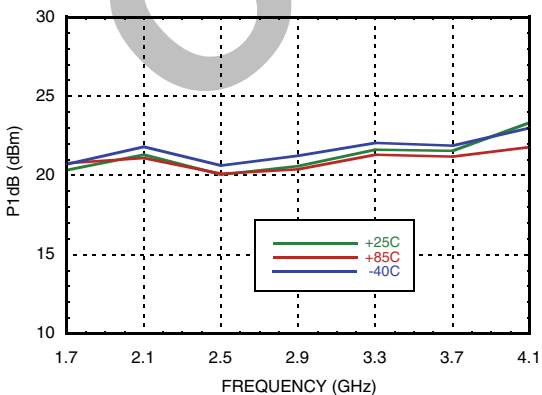

**MxN Spurious @ IF Port**

mRF	nLO				
	0	1	2	3	4
0	xx	-11	-1	6	10
1	5	0	16	37	36
2	58	67	55	51	60
3	98	102	103	82	91
4	99	99	104	106	107

RF Freq. = 3 GHz @ -10 dBm  
 LO Freq. = 2.8 GHz @ 0 dBm  
 All values in dBc relative to the IF power level.

Information furnished by Analog Devices is believed to be accurate and reliable. However, no responsibility is assumed by Analog Devices for its use, nor for any infringements of patents or other rights of third parties that may result from its use. Specifications subject to change without notice. No license is granted by implication or otherwise under any patent or patent rights of Analog Devices. Trademarks and registered trademarks are the property of their respective owners.

For price, delivery, and to place orders: Analog Devices, Inc., One Technology Way, P.O. Box 9106, Norwood, MA 02062-9106 Phone: 781-329-4700 • Order online at [www.analog.com](http://www.analog.com) Application Support: Phone: 1-800-ANALOG-D



## GaAs MMIC MIXER w/ INTEGRATED LO AMPLIFIER, 2.3 - 4.0 GHz

### Absolute Maximum Ratings

RF / IF Input (Vcc= +5V)	+27 dBm
LO Drive (Vcc= +5V)	+10 dBm
BIAS	+7 Vdc
Junction Temperature	150°C
Continuous Pdiss (T = 85°C) (derate 5.21 mW/°C above 85°C)	0.339 W
Thermal Resistance (junction to ground paddle)	192 °C/W
Storage Temperature	-65 to +150°C
Operating Temperature	-40 to +85°C

### Harmonics of LO

LO Freq. (GHz)	nLO Spur @ RF Port			
	1	2	3	4
1	8	13	29	31
1.8	5	23	18	34
2.6	11	12	27	30
3.4	15	16	48	27
4.2	7	18	27	27
5	16	27	38	43

LO = 0 dBm  
All values in dBc below input LO level measured at RF port.



ELECTROSTATIC SENSITIVE DEVICE  
OBSERVE HANDLING PRECAUTIONS

### Typical Supply Current

Vcc	Icc (mA)
+5.0	65 mA

### Outline Drawing

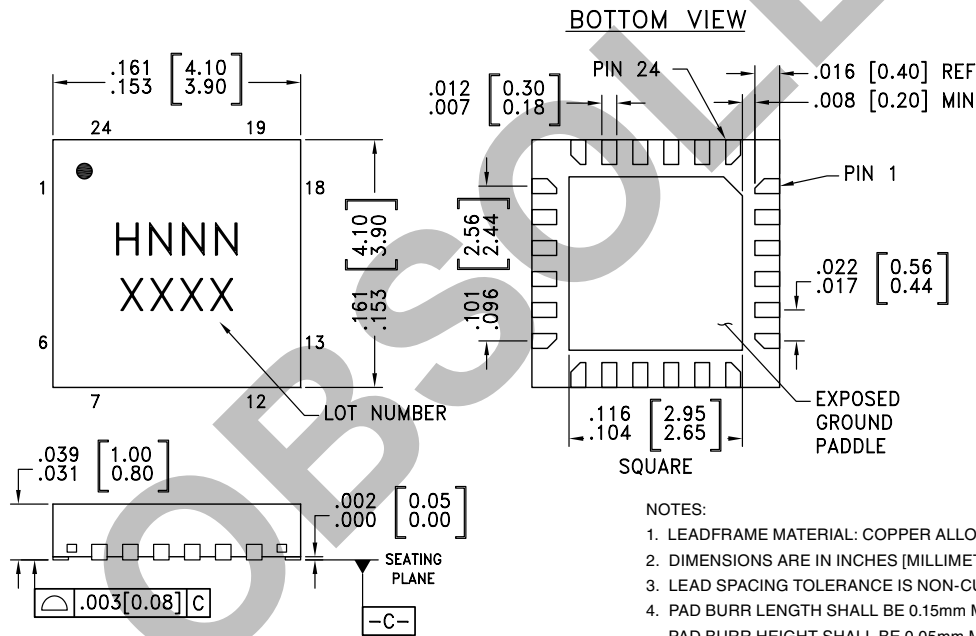

#### NOTES:

- LEADFRAME MATERIAL: COPPER ALLOY
- DIMENSIONS ARE IN INCHES [MILLIMETERS]
- LEAD SPACING TOLERANCE IS NON-CUMULATIVE.
- PAD BURR LENGTH SHALL BE 0.15mm MAXIMUM.  
PAD BURR HEIGHT SHALL BE 0.05mm MAXIMUM.
- PACKAGE WARP SHALL NOT EXCEED 0.05mm.
- ALL GROUND LEADS AND GROUND PADDLE MUST BE SOLDERED TO PCB RF GROUND.
- REFER TO HITTITE APPLICATION NOTE FOR SUGGESTED LAND PATTERN.

### Package Information

Part Number	Package Body Material	Lead Finish	MSL Rating	Package Marking <sup>[3]</sup>
HMC615LP4	Low Stress Injection Molded Plastic <sup>[4]</sup>	Sn/Pb Solder	MSL1 <sup>[1]</sup>	H615 XXXX
HMC615LP4E	RoHS-compliant Low Stress Injection Molded Plastic	100% matte Sn	MSL1 <sup>[2]</sup>	H615 XXXX

[1] Max peak reflow temperature of 235 °C

[2] Max peak reflow temperature of 260 °C

[3] 4-Digit lot number XXXX

[4] For availability of Non-RoHS HMC615LP4 products please contact Hittite Microwave sales directly.



## GaAs MMIC MIXER w/ INTEGRATED LO AMPLIFIER, 2.3 - 4.0 GHz

### Pin Descriptions

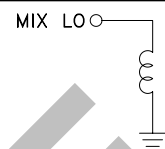
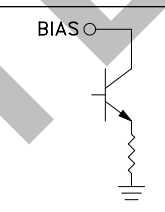
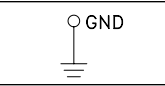
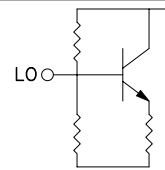
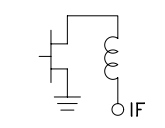
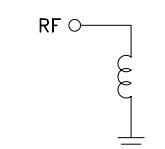
Pin Number	Function	Description	Interface Schematic
1	MIX LO	This pin is DC coupled and matched to 50 Ohms. An off chip DC blocking capacitor is required.	
2, 6 - 9, 11 - 17, 19 - 24	N/C	No connection. These pins may be connected to RF ground. Performance will not be affected.	
3	BIAS	Power supply for the LO amplifier, a Bias resistor is required. Three external bypass capacitors are recommended for optimum performance, as illustrated in the application circuit.	
4	GND	Backside of package has exposed metal ground paddle that must also be connected to ground.	
5	LO	This pin is DC coupled and matched to 50 Ohms. An off chip DC blocking capacitor is required.	
10	IF	This pin is DC coupled. For applications not requiring operation to DC, this port should be DC blocked externally using a series capacitor whose value has been chosen to pass the necessary IF frequency range. For operation to DC, this pin must not source/sink more than 18 mA of current or die non-function and possible die failure will result.	
18	RF	This pin is DC coupled and matched to 50 Ohms.	



**GaAs MMIC MIXER w/ INTEGRATED LO AMPLIFIER, 2.3 - 4.0 GHz**

**Application Circuit**

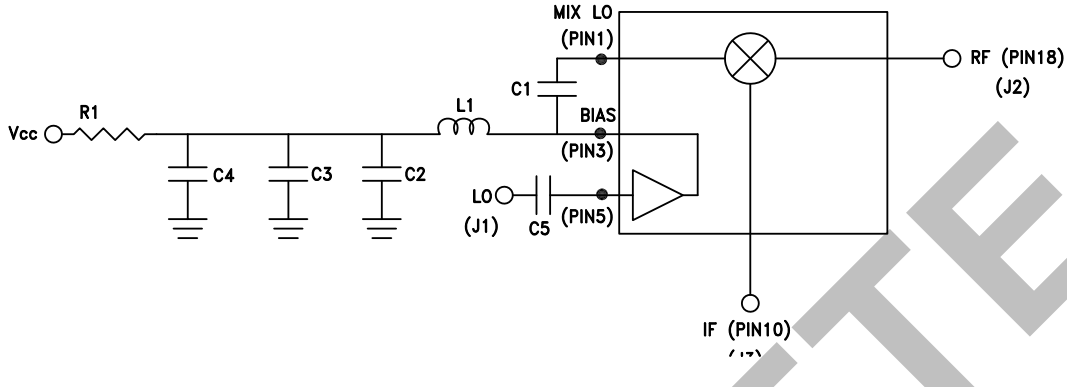

**Evaluation PCB**

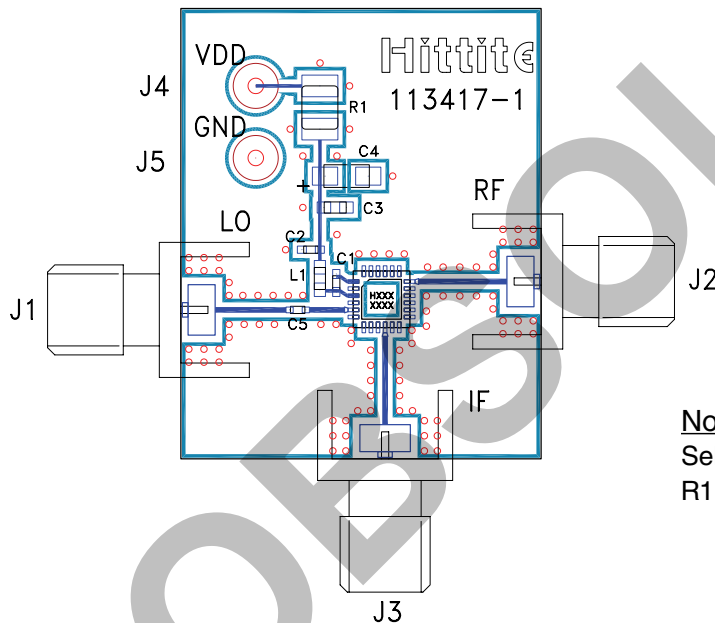

Recommended Components Values (IF = DC - 300 MHz)	
C3	1000 pF
C4	2.2 μF
C1, C2, C5	100 pF
L1	18 nH
R1	18 Ohm

**Note :**

Select R1 to achieve I<sub>cc</sub> by using equation below, R1 ≥ 18 Ohms.

$$I_{cc} = (V_s - 3.8) / R1$$

**List of Materials for Evaluation PCB 115906 [1]**

Item	Description
J1 - J3	PCB Mount SMA RF Connector
J4, J5	DC Pin
C1, C2, C5	100 pF Chip Capacitor, 0402 Pkg.
C3	1000 pF Chip Capacitor, 0603 Pkg.
C4	2.2 μF Capacitor, Tantalum
L1	18 nH Chip Inductor, 0603 Pkg.
R1	18 Ohm Resistor, 1210 1/8 watt Pkg.
U1	HMC615LP4E
PCB [2]	113417 Evaluation Board

[1] Reference this number when ordering complete evaluation PCB

[2] Circuit Board Material: Rogers 4350

The circuit board used in the application should use RF circuit design techniques. Signal lines should have 50 Ohm impedance while the package ground leads and exposed paddle should be connected directly to the ground plane similar to that shown. A sufficient number of via holes should be used to connect the top and bottom ground planes. The evaluation circuit board shown is available from Hittite upon request.