



Chipsmall Limited consists of a professional team with an average of over 10 year of expertise in the distribution of electronic components. Based in Hongkong, we have already established firm and mutual-benefit business relationships with customers from,Europe,America and south Asia,supplying obsolete and hard-to-find components to meet their specific needs.

With the principle of “Quality Parts,Customers Priority,Honest Operation,and Considerate Service”,our business mainly focus on the distribution of electronic components. Line cards we deal with include Microchip,ALPS,ROHM,Xilinx,Pulse,ON,Everlight and Freescale. Main products comprise IC,Modules,Potentiometer,IC Socket,Relay,Connector.Our parts cover such applications as commercial,industrial, and automotives areas.

We are looking forward to setting up business relationship with you and hope to provide you with the best service and solution. Let us make a better world for our industry!



## Contact us

Tel: +86-755-8981 8866 Fax: +86-755-8427 6832

Email & Skype: info@chipsmall.com Web: www.chipsmall.com

Address: A1208, Overseas Decoration Building, #122 Zhenhua RD., Futian, Shenzhen, China



## BiCMOS MMIC MIXER W/ INTEGRATED LO AMPLIFIER, 700 - 1000 MHz



### Typical Applications

The HMC684LP4(E) is Ideal for:

- Cellular/3G & LTE/WiMAX/4G
- Basestations & Repeaters
- GSM, CDMA & OFDM
- Transmitters and Receivers

### Features

- High Input IP3: +32 dBm
- Low Conversion Loss: 7 dB
- Low LO Drive: 0 dBm
- Upconversion & Downconversion Applications
- 24 Lead 4x4mm SMT Package: 16mm<sup>2</sup>

### Functional Diagram

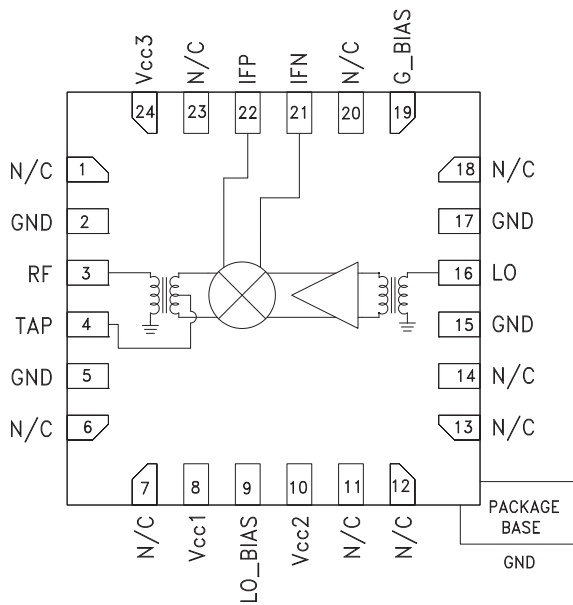

### General Description

The HMC684LP4(E) is a high dynamic range passive MMIC mixer with integrated LO amplifier in a 4x4 SMT QFN package covering 0.7 to 1.0 GHz. Excellent input IP3 performance of +32 dBm for down conversion is provided for 3G & 4G GSM/CDMA applications at an LO drive of 0 dBm. With an input 1 dB compression of +25 dBm, the RF port will accept a wide range of input signal levels. Conversion loss is 7 dB typical. The DC to 450 MHz IF frequency response will satisfy GSM/CDMA transmit or receive frequency plans. The HMC684LP4(E) is pin for pin compatible with the HMC685LP4(E) which is a 1.7 - 2.2 GHz mixer with LO amplifier.

### Electrical Specifications

$T_A = +25^\circ C$ ,  $IF = 100 MHz$ ,  $LO = 0 dBm$ ,  $V_{cc1, 2, 3} = +5V$ ,  $G_{Bias} = +3.5V^*$

| Parameter                            | Min. | Typ.      | Max. | Units |
|--------------------------------------|------|-----------|------|-------|
| Frequency Range, RF                  |      | 0.7 - 1.0 |      | GHz   |
| Frequency Range, LO                  |      | 0.6 - 1.0 |      | GHz   |
| Frequency Range, IF                  |      | DC to 450 |      | MHz   |
| Conversion Loss                      |      | 7         | 9    | dB    |
| Noise Figure (SSB)                   |      | 7         |      | dB    |
| LO to RF Isolation                   | 17   | 23        |      | dB    |
| LO to IF Isolation                   | 20   | 30        |      | dB    |
| RF to IF Isolation                   | 25   | 35        |      | dB    |
| IP3 (Input)                          |      | 32        |      | dBm   |
| 1 dB Compression (Input)             |      | 25        |      | dBm   |
| LO Drive Input Level (Typical)       |      | -6 to +3  |      | dBm   |
| Supply Current I <sub>cc</sub> Total |      | 85        | 100  | mA    |

\* Unless otherwise noted all measurements performed as downconverter with low side LO & IF = 100 MHz.

# HMC684\* PRODUCT PAGE QUICK LINKS

Last Content Update: 02/23/2017

---

## COMPARABLE PARTS

View a parametric search of comparable parts.

## EVALUATION KITS

- HMC684LP4 Evaluation Board

## DOCUMENTATION

### Data Sheet

- HMC684 Data Sheet

## REFERENCE MATERIALS

### Quality Documentation

- Package/Assembly Qualification Test Report: LP4, LP4B, LP4C, LP4K (QTR: 2013-00487 REV: 04)
- Semiconductor Qualification Test Report: BiCMOS-A (QTR: 2013-00235)

## DESIGN RESOURCES

- HMC684 Material Declaration
- PCN-PDN Information
- Quality And Reliability
- Symbols and Footprints

## DISCUSSIONS

View all HMC684 EngineerZone Discussions.

## SAMPLE AND BUY

Visit the product page to see pricing options.

## TECHNICAL SUPPORT

Submit a technical question or find your regional support number.

## DOCUMENT FEEDBACK

Submit feedback for this data sheet.

---



**BiCMOS MMIC MIXER W/ INTEGRATED  
LO AMPLIFIER, 700 - 1000 MHz**

**Conversion Gain vs. Temperature**

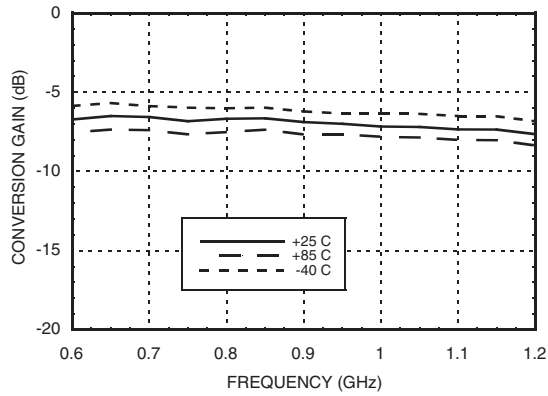

**Isolation**

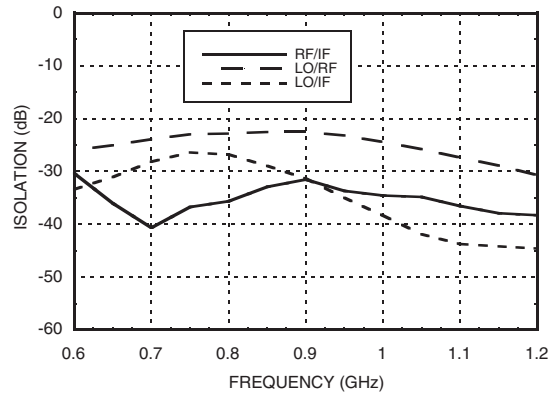

**Conversion Gain vs. LO Drive**

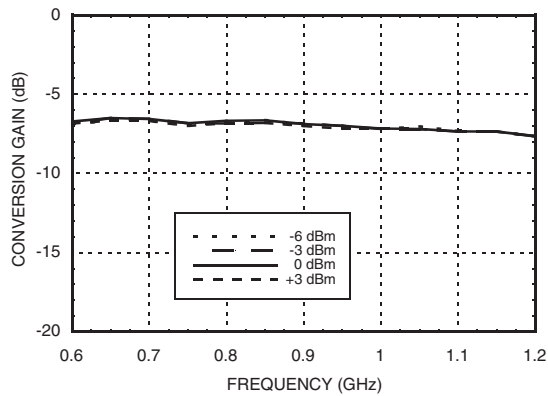

**Return Loss**

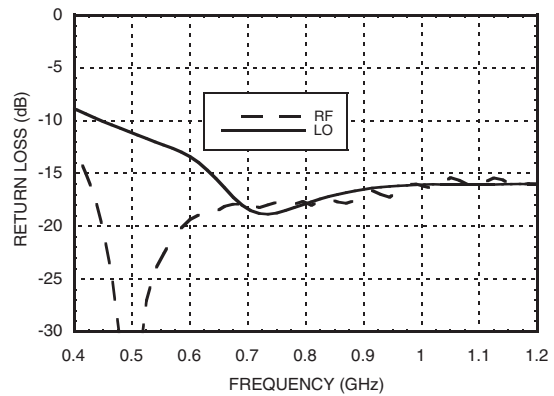

**IF Bandwidth (LO = 0.8 GHz)**

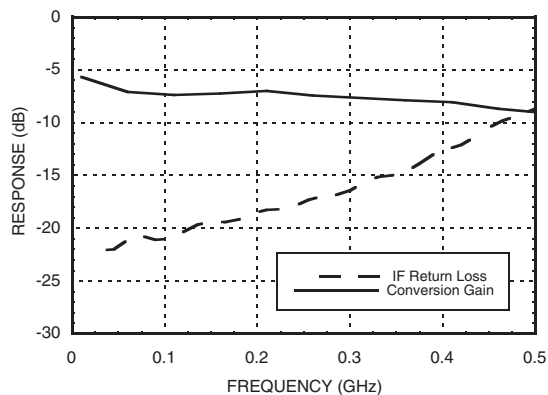

**Input P1dB vs. Temperature**

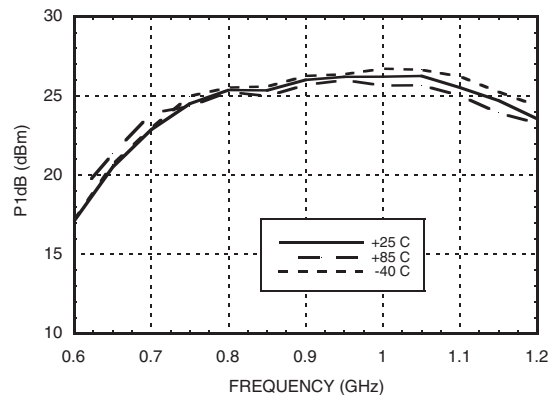

Information furnished by Analog Devices is believed to be accurate and reliable. However, no responsibility is assumed by Analog Devices for its use, nor for any infringements of patents or other rights of third parties that may result from its use. Specifications subject to change without notice. No license is granted by implication or otherwise under any patent or patent rights of Analog Devices. Trademarks and registered trademarks are the property of their respective owners.

For price, delivery, and to place orders: Analog Devices, Inc., One Technology Way, P.O. Box 9106, Norwood, MA 02062-9106 Phone: 781-329-4700 • Order online at [www.analog.com](http://www.analog.com) Application Support: Phone: 1-800-ANALOG-D

10

MIXERS - SINGLE & DOUBLE BALANCED - SMT

**BiCMOS MMIC MIXER W/ INTEGRATED LO AMPLIFIER, 700 - 1000 MHz**



**Input IP3 vs. LO Drive <sup>[1]</sup>**

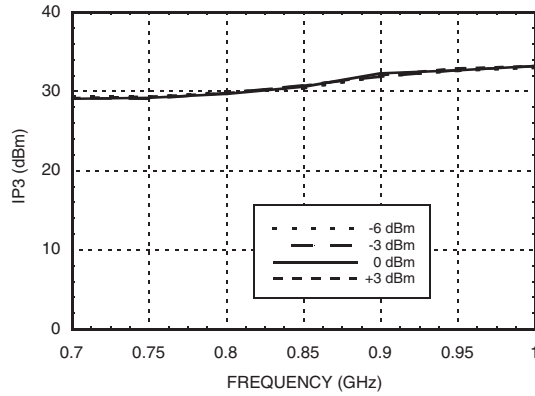

**Input IP3 vs. Temperature <sup>[1]</sup>**

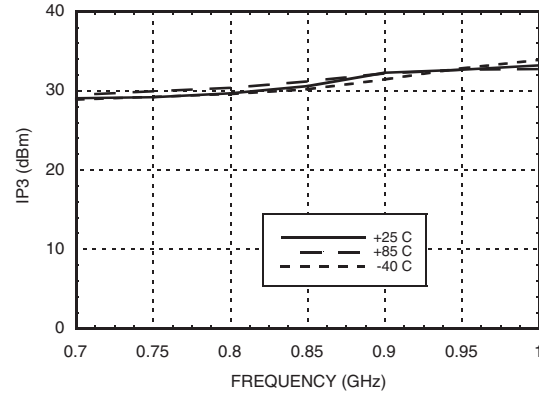

**+2RF -2LO Response vs. Temperature <sup>[2]</sup>**

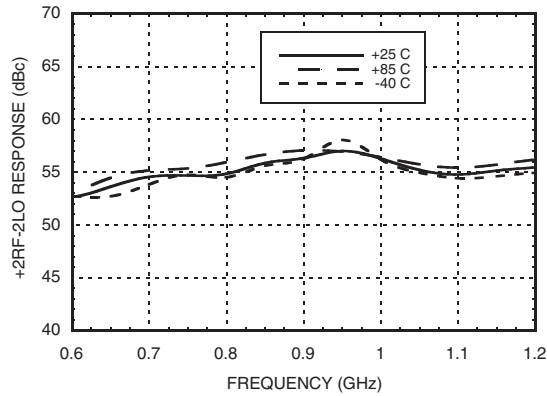

**+2RF -2LO Response vs. LO Drive <sup>[2]</sup>**

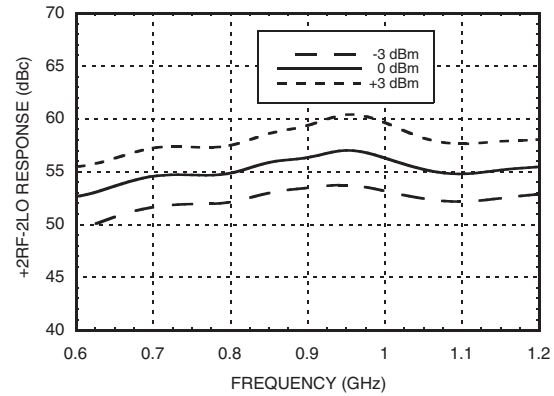

**+3RF -3LO Response vs. Temperature <sup>[2]</sup>**

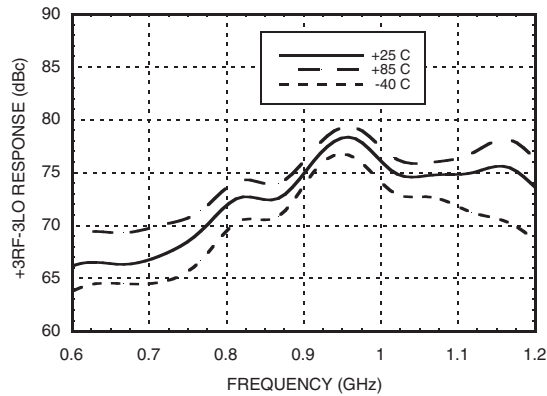

**+3RF -3LO Response vs. LO Drive <sup>[2]</sup>**

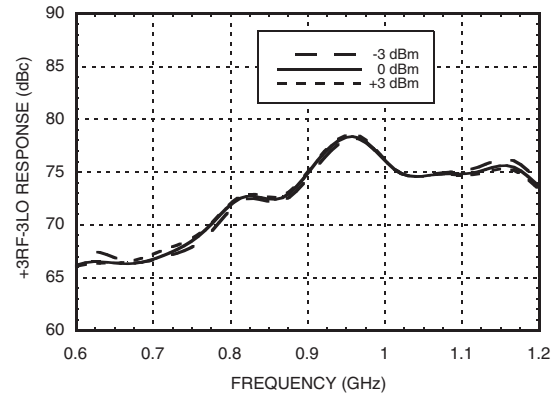

[1] Two-tone input power = +9 dBm each tone, 1 MHz spacing. [2] Reference to RF Power at 0 dBm

## BiCMOS MMIC MIXER W/ INTEGRATED LO AMPLIFIER, 700 - 1000 MHz



### Upconverter Performance Conversion Gain vs. LO Drive

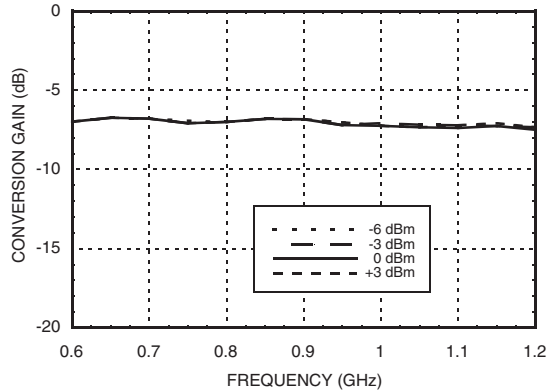

### Upconverter Performance Input IP3 vs. LO Drive

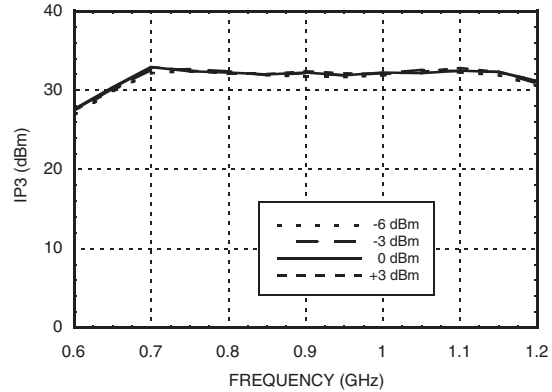

### Absolute Maximum Ratings

|  |               |
|--|---------------|
| RF / IF Input (Vcc1 - 3 = +5V)   | +26 dBm       |
| LO Drive (Vcc = +5V)   | +10 dBm       |
| Vcc1 - 3 (LO or IF)  | 5.5V          |
| Channel Temperature  | 125 °C        |
| Continuous P <sub>diss</sub> (T = 85°C)<br>(derate 17.24 mW/°C above 85°C) | 0.69W         |
| Thermal Resistance<br>(channel to ground paddle)                           | 58 °C/W       |
| Storage Temperature  | -65 to 150 °C |
| Operating Temperature  | -40 to +85 °C |
| ESD Sensitivity (HBM)  | Class 1A      |

### MxN Spurious @ IF Port

| mRF | nLO |     |     |     |    |
|-----|-----|-----|-----|-----|----|
|     | 0   | 1   | 2   | 3   | 4  |
| 0   | xx  | 25  | 16  | 25  | 31 |
| 1   | 25  | 0   | 25  | 17  | 35 |
| 2   | 52  | 47  | 50  | 55  | 58 |
| 3   | 82  | 73  | 92  | 70  | 77 |
| 4   | 112 | 100 | 112 | 110 | 98 |

RF Freq. = 0.9 GHz @ 0 dBm  
LO Freq. = 0.8 GHz @ 0 dBm  
All values in dBc below IF power level (1RF - 1LO).



**ELECTROSTATIC SENSITIVE DEVICE  
OBSERVE HANDLING PRECAUTIONS**

### Typical Vcc1 Current vs. Vcc

| Vcc1 - 3 (V) | I <sub>cc</sub> Total (mA) |
|--------------|----------------------------|
| 4.75         | 80                         |
| 5.00         | 85                         |
| 5.25         | 90                         |

Product will operate over full voltage range shown above.

### Harmonics of LO

| LO Freq. (GHz) | nLO Spur @ RF Port |    |    |    |
|----------------|--------------------|----|----|----|
|                | 1                  | 2  | 3  | 4  |
| 0.5            | 26                 | 45 | 36 | 43 |
| 0.6            | 24                 | 43 | 35 | 36 |
| 0.7            | 22                 | 30 | 41 | 30 |
| 0.8            | 22                 | 30 | 34 | 28 |
| 0.9            | 24                 | 31 | 37 | 31 |
| 1              | 27                 | 32 | 37 | 44 |
| 1.1            | 31                 | 28 | 45 | 30 |

LO = 0 dBm  
All values in dBc below input LO level measured at RF port

**BiCMOS MMIC MIXER W/ INTEGRATED LO AMPLIFIER, 700 - 1000 MHz**



**Outline Drawing**

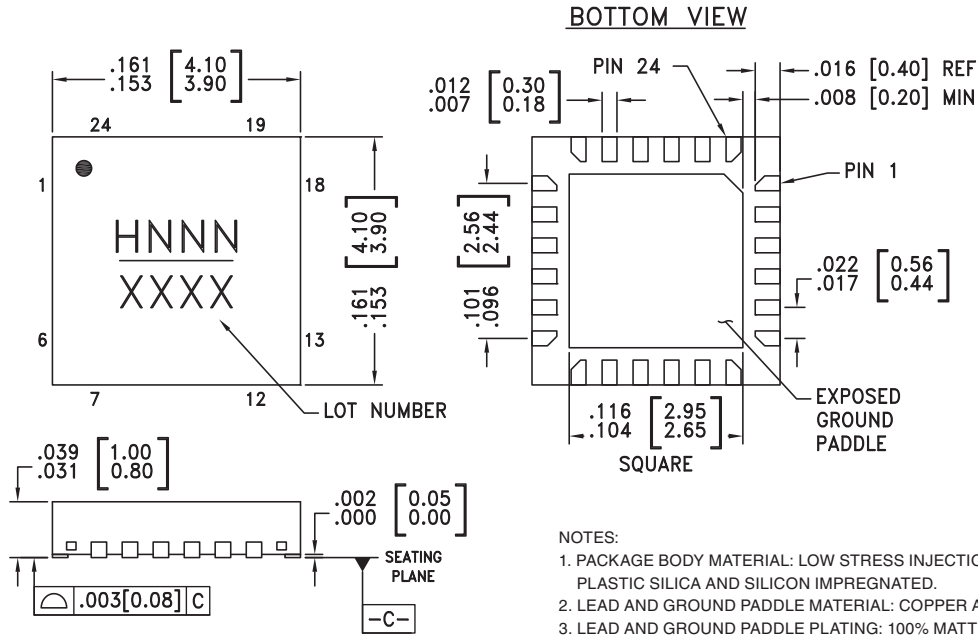

- NOTES:
1. PACKAGE BODY MATERIAL: LOW STRESS INJECTION MOLDED PLASTIC SILICA AND SILICON IMPREGNATED.
  2. LEAD AND GROUND PADDLE MATERIAL: COPPER ALLOY.
  3. LEAD AND GROUND PADDLE PLATING: 100% MATTE TIN.
  4. DIMENSIONS ARE IN INCHES [MILLIMETERS].
  5. LEAD SPACING TOLERANCE IS NON-CUMULATIVE.
  6. PAD BURR LENGTH SHALL BE 0.15mm MAX. PAD BURR HEIGHT SHALL BE 0.25mm MAX.
  7. PACKAGE WARP SHALL NOT EXCEED 0.05mm
  8. ALL GROUND LEADS AND GROUND PADDLE MUST BE SOLDERED TO PCB RF GROUND.
  9. REFER TO HITTITE APPLICATION NOTE FOR SUGGESTED PCB LAND PATTERN.

**Package Information**

| Part Number | Package Body Material                              | Lead Finish   | MSL Rating          | Package Marking <sup>[3]</sup> |
|-------------|--|---------------|---------------------|--------------------------------|
| HMC684LP4   | Low Stress Injection Molded Plastic                | Sn/Pb Solder  | MSL1 <sup>[1]</sup> | H684<br>XXXX                   |
| HMC684LP4E  | RoHS-compliant Low Stress Injection Molded Plastic | 100% matte Sn | MSL1 <sup>[2]</sup> | H684<br>XXXX                   |

[1] Max peak reflow temperature of 235 °C  
 [2] Max peak reflow temperature of 260 °C  
 [3] 4-Digit lot number XXXX

***BiCMOS MMIC MIXER W/ INTEGRATED  
LO AMPLIFIER, 700 - 1000 MHz***

**Pin Descriptions**

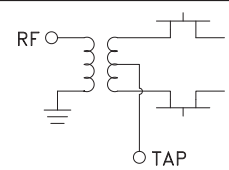
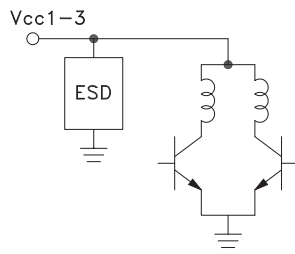
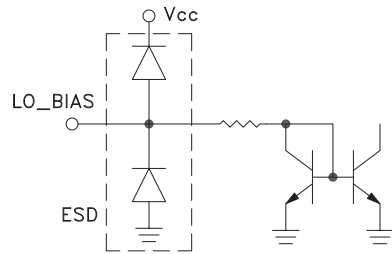
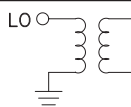
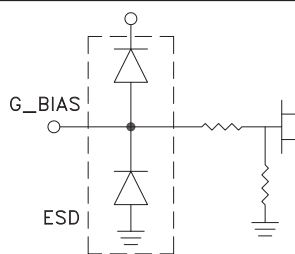
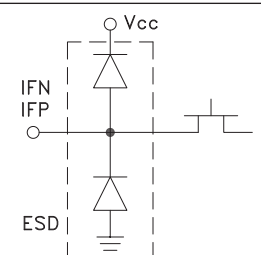
| Pin Number                   | Function         | Description   | Interface Schematic   |
|------------------------------|------------------|---|---|
| 1, 6, 7, 11 - 14, 18, 20, 23 | N/C              | No connection. These pins may be connected to RF ground. Performance will not be affected.  |   |
| 2, 5, 15, 17                 | GND              | Package bottom must be connected to RF/DC ground.   |    |
| 3                            | RF               | This pin is matched single-ended 50 Ohm and DC shorted to ground through a balun.   |    |
| 4                            | TAP              | Center tap of secondary side of the internal RF balun. Short to ground with a zero ohm close to the package.  |   |
| 8, 10, 24                    | Vcc1, Vcc2, Vcc3 | Power supply voltage. See application circuit for required external components.   |   |
| 9                            | LO_BIAS          | Adjust the LO buffer current through an external resistor. See application circuit for required external components.  |  |
| 16                           | LO               | This pin is matched single-ended 50 Ohm and DC shorted to ground through a balun.   |  |
| 19                           | G_BIAS           | External optional bias. See application circuit for required external components.   |  |
| 21, 22                       | IFN, IFP         | Differential IF input / output pins matched to differential 50 Ohms. For applications not requiring operation to DC an off chip DC blocking capacitor should be used. |  |



**BiCMOS MMIC MIXER W/ INTEGRATED LO AMPLIFIER, 700 - 1000 MHz**



**Evaluation PCB**

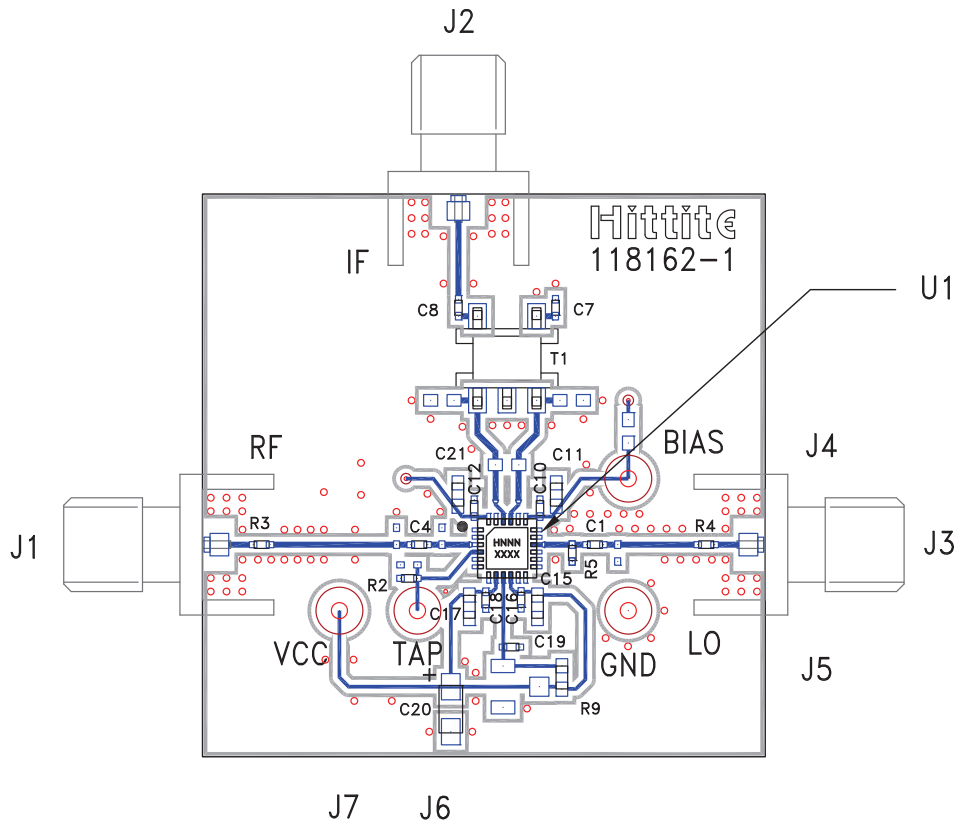

**List of Materials for Evaluation PCB 119920 [1]**

| Item               | Description                       |
|--------------------|-----------------------------------|
| J1 - J3            | SMA Connector                     |
| J4 - J7            | DC Pin                            |
| C1, C19            | 22 pF Capacitor, 0402 Pkg.        |
| C4                 | 6.8 pF Capacitor, 0402 Pkg.       |
| C7, C8             | 10 nF Capacitor, 0402 Pkg.        |
| C10, C12, C16, C18 | 1 nF Capacitor, 0402 Pkg.         |
| C11, C15, C17, C21 | 0.1 μF Capacitor, 0603 Pkg.       |
| C20                | 4.7 μF Case A, Tantalum           |
| R2 - R4            | 0 Ohm Resistor, 0402 Pkg.         |
| R5                 | 68 Ohm Resistor, 0402 Pkg.        |
| R9                 | 390 Ohm Resistor, 0603 Pkg.       |
| T1                 | 1:1 Transformer - Tyco MABACT0039 |
| U1                 | HMC684LP4(E) Downconverter        |
| PCB [2]            | 118162 Evaluation PCB             |

The circuit board used in the application should use RF circuit design techniques. Signal lines should have 50 Ohm impedance while the package ground leads and exposed paddle should be connected directly to the ground plane similar to that shown. A sufficient number of via holes should be used to connect the top and bottom ground planes. The evaluation circuit board shown is available from Hittite upon request.

[1] Reference this number when ordering complete evaluation PCB

[2] Circuit Board Material: Arlon 25R, FR4

**BiCMOS MMIC MIXER W/ INTEGRATED LO AMPLIFIER, 700 - 1000 MHz**



**Application Circuit**

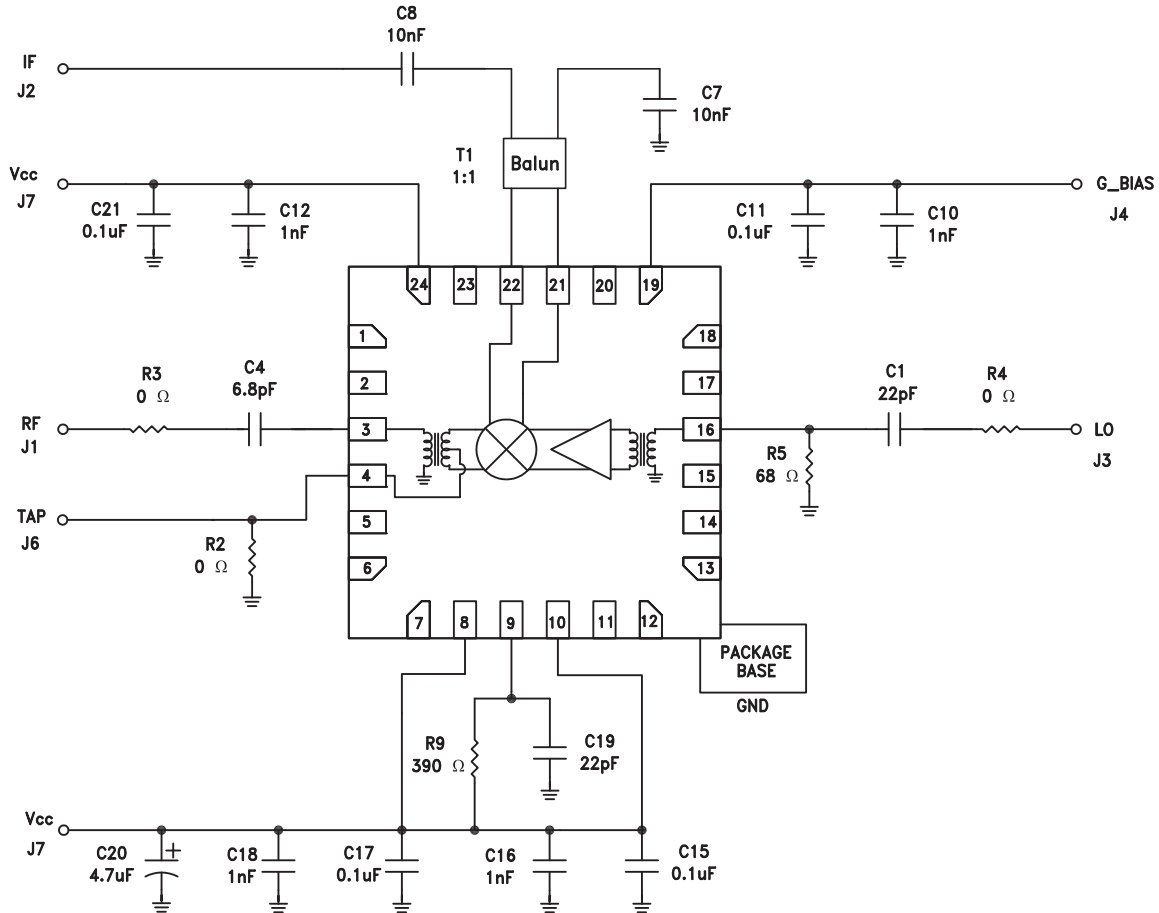

10

MIXERS - SINGLE & DOUBLE BALANCED - SMT

Information furnished by Analog Devices is believed to be accurate and reliable. However, no responsibility is assumed by Analog Devices for its use, nor for any infringements of patents or other rights of third parties that may result from its use. Specifications subject to change without notice. No license is granted by implication or otherwise under any patent or patent rights of Analog Devices. Trademarks and registered trademarks are the property of their respective owners.

For price, delivery, and to place orders: Analog Devices, Inc., One Technology Way, P.O. Box 9106, Norwood, MA 02062-9106 Phone: 781-329-4700 • Order online at [www.analog.com](http://www.analog.com) Application Support: Phone: 1-800-ANALOG-D