



Chipsmall Limited consists of a professional team with an average of over 10 year of expertise in the distribution of electronic components. Based in Hongkong, we have already established firm and mutual-benefit business relationships with customers from,Europe,America and south Asia,supplying obsolete and hard-to-find components to meet their specific needs.

With the principle of "Quality Parts,Customers Priority,Honest Operation,and Considerate Service",our business mainly focus on the distribution of electronic components. Line cards we deal with include Microchip,ALPS,ROHM,Xilinx,Pulse,ON,Everlight and Freescale. Main products comprise IC,Modules,Potentiometer,IC Socket,Relay,Connector.Our parts cover such applications as commercial,industrial, and automotives areas.

We are looking forward to setting up business relationship with you and hope to provide you with the best service and solution. Let us make a better world for our industry!



Contact us

Tel: +86-755-8981 8866 Fax: +86-755-8427 6832

Email & Skype: info@chipsmall.com Web: www.chipsmall.com

Address: A1208, Overseas Decoration Building, #122 Zhenhua RD., Futian, Shenzhen, China





GaAs MMIC ANALOG VARIABLE GAIN AMPLIFIER, 6 - 17 GHz

Typical Applications

The HMC694LP4(E) is ideal for:

- Point-to-Point Radio
- Point-to-Multi-Point Radio
- EW & ECM
- X-Band Radar
- Test Equipment

Features

- Wide Gain Control Range: 23 dB
- Single Control Voltage
- Output IP3 @ Max Gain: +30 dBm
- Output P1dB: +22 dBm
- No External Matching
- 24 Lead 4x4 mm SMT Package: 16 mm²

Functional Diagram

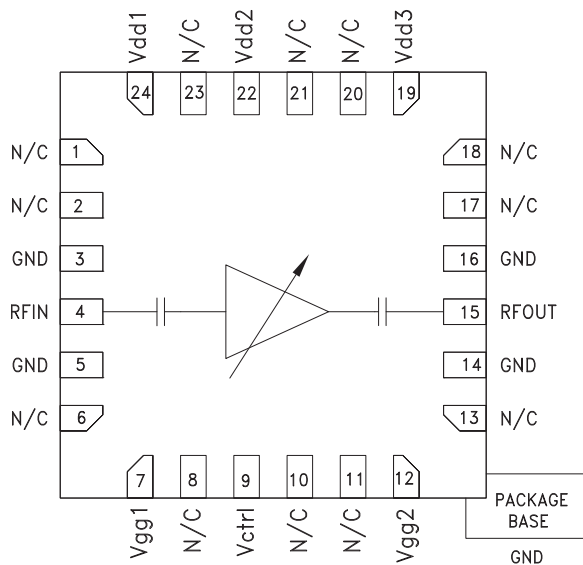

General Description

The HMC694LP4(E) is a GaAs MMIC PHEMT analog variable gain amplifier which operates between 6 and 17 GHz. Ideal for microwave radio applications, the amplifier provides up to 22 dB of gain, output P1 dB of up to +22 dBm, and up to +30 dBm of output IP3 at maximum gain, while requiring only 175 mA from a +5V supply. A gate bias pin (Vctrl) is provided to allow variable gain control up to 23 dB. Gain flatness is excellent making the HMC694LP4E ideal for EW, ECM and radar applications. The HMC694LP4E is housed in a RoHS compliant 4x4 mm QFN leadless package and is compatible with high volume surface mount manufacturing.

Electrical Specifications, $T_A = +25^\circ\text{C}$, $V_{dd1, 2, 3} = 5\text{V}$, $V_{ctrl} = -2\text{V}$, $I_{dd} = 170\text{mA}^*$

Parameter	Min.	Typ.	Max.	Min.	Typ.	Max.	Units
Frequency Range		6 - 10		10 - 17			GHz
Gain	19	22		14	18		dB
Gain Flatness		± 1			± 1.5		dB
Gain Variation Over Temperature		0.015			0.015		dB/ °C
Gain Control Range		23			20		dB
Noise Figure		6	7.5		6	6.5	dB
Input Return Loss		15			8		dB
Output Return Loss		10			8		dB
Output Power for 1 dB Compression (P1dB)	19	21		21	22		dBm
Saturated Output Power (Psat)		22			23		dBm
Output Third Order Intercept (IP3)		30			30		dBm
Total Supply Current (Idd)		175			175		mA

*Set Vctrl = -2V and then adjust Vgg1, 2 between -2V to 0V (typ. -0.8V) to achieve Idd = 170mA typical.



GaAs MMIC ANALOG VARIABLE GAIN AMPLIFIER, 6 - 17 GHz

Control Voltage Range vs. Gain

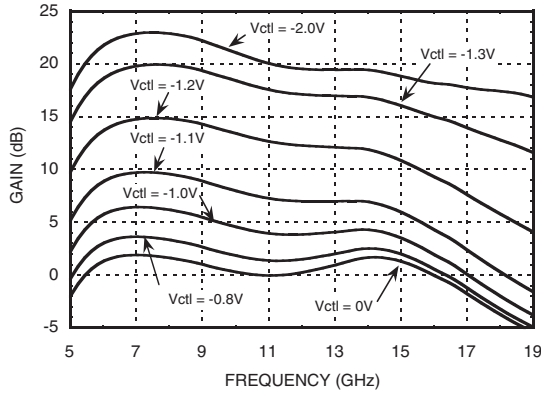

Gain vs. Control Voltage

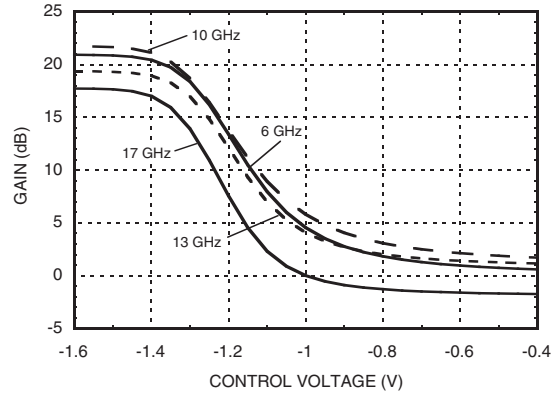

Broadband Gain & Return Loss

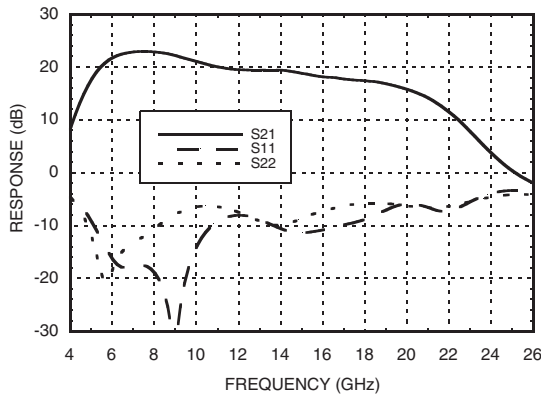

Gain vs. Temperature

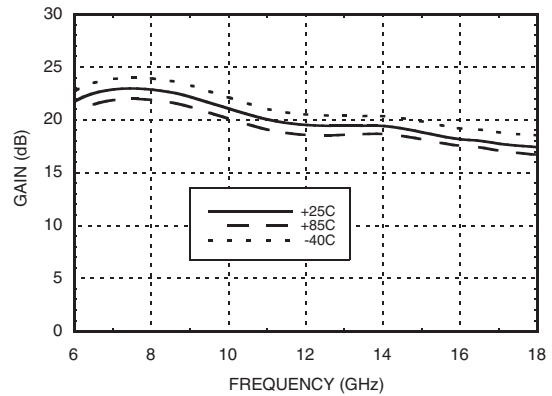

Input Return Loss vs. Temperature

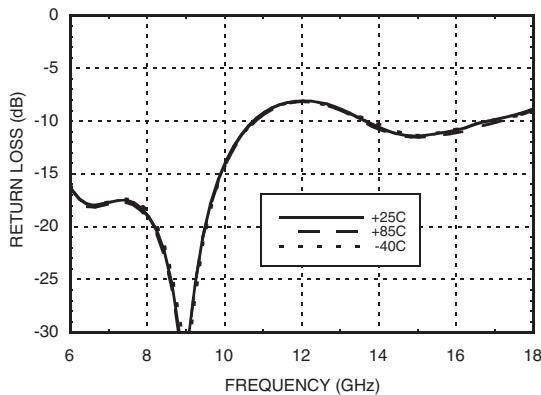

Output Return Loss vs. Temperature

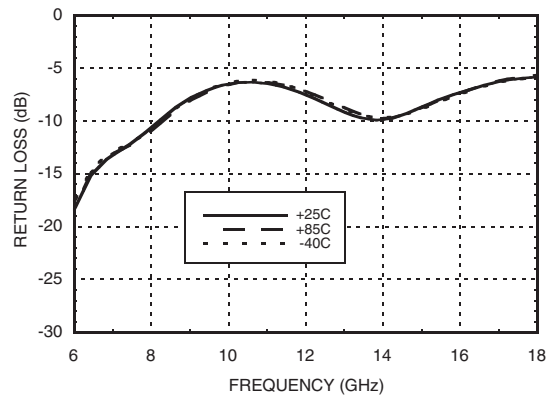

Information furnished by Analog Devices is believed to be accurate and reliable. However, no responsibility is assumed by Analog Devices for its use, nor for any infringements of patents or other rights of third parties that may result from its use. Specifications subject to change without notice. No license is granted by implication or otherwise under any patent or patent rights of Analog Devices. Trademarks and registered trademarks are the property of their respective owners.

For price, delivery, and to place orders: Analog Devices, Inc., One Technology Way, P.O. Box 9106, Norwood, MA 02062-9106 Phone: 781-329-4700 • Order online at www.analog.com Application Support: Phone: 1-800-ANALOG-D



GaAs MMIC ANALOG VARIABLE GAIN AMPLIFIER, 6 - 17 GHz

Return Loss @ Voltage Extreme

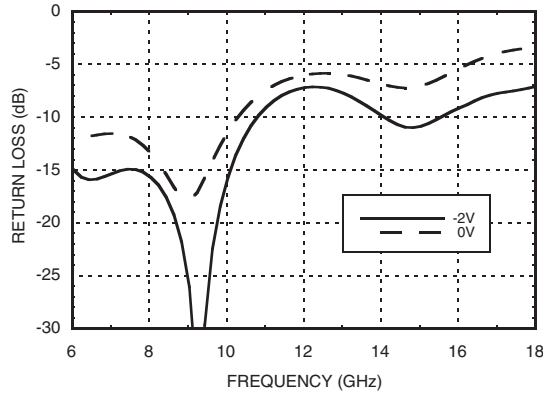

Output Return Loss @ Voltage Extreme

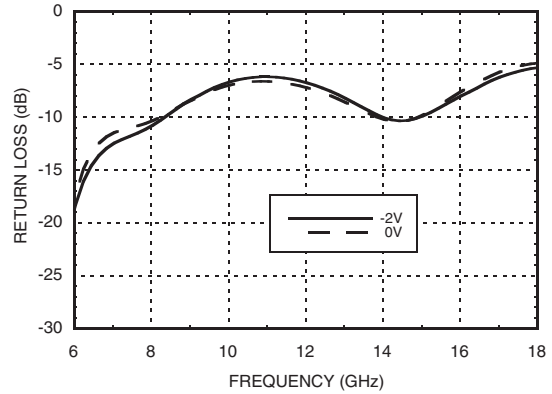

Noise Figure vs. Temperature

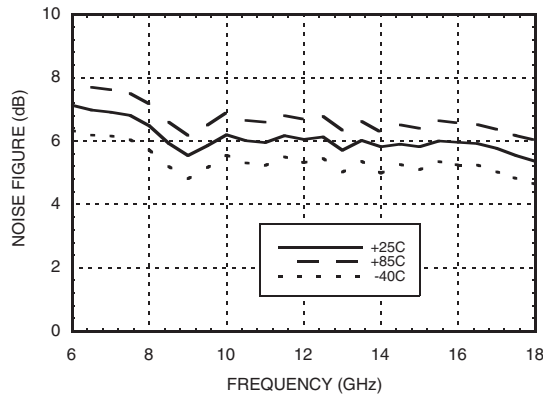

Noise Figure vs. CTRL

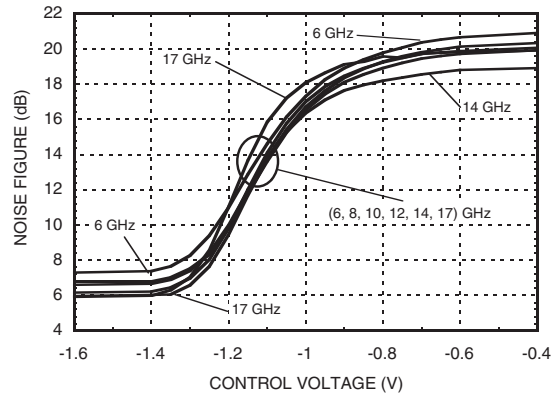

P1dB vs. Temperature

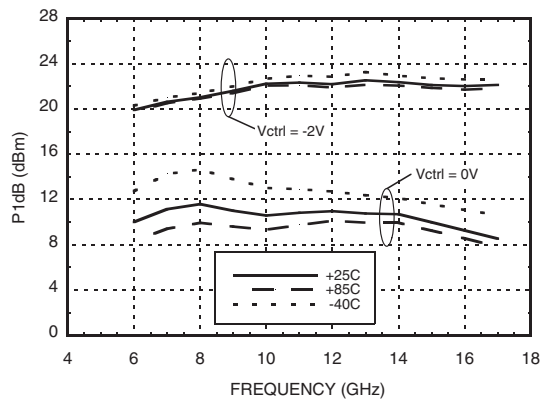

Psat vs. Temperature

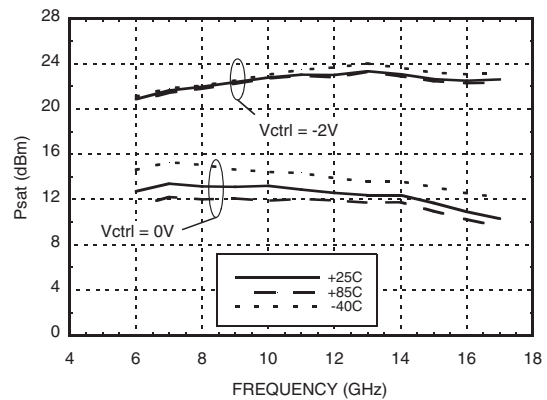

[1] Tested with broadband bias tee on RF ports and C1 = 10,000pF
 [2] C1, C6 and C8 = 100pF, L1 = 24nF



GaAs MMIC ANALOG VARIABLE GAIN AMPLIFIER, 6 - 17 GHz

Reverse Isolation vs. Temperature

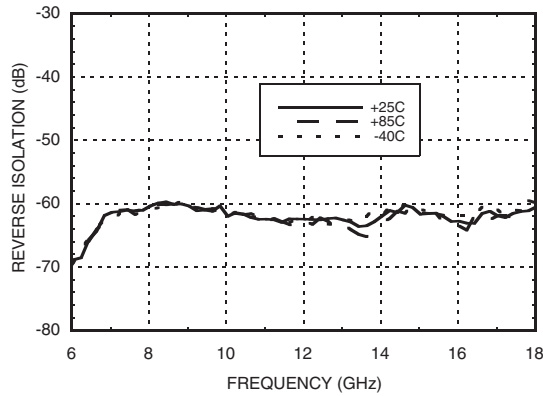

Output IP3 vs. Temperature

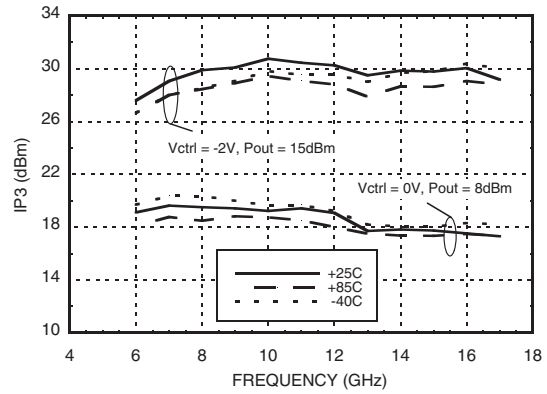

Output IP3 @ 0 dBm

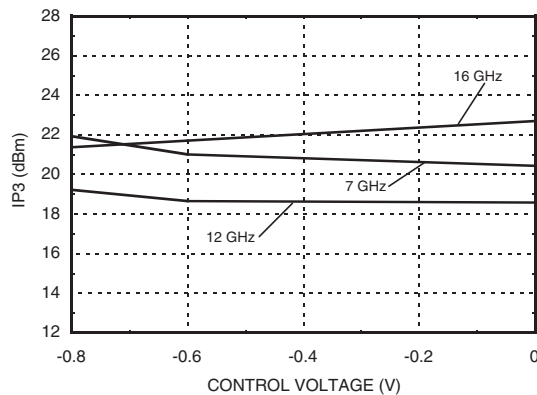

Output IP3 @ 5 dBm

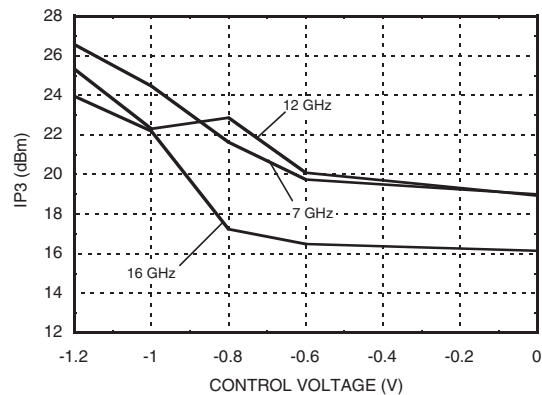

Output IP3 @ 10 dBm

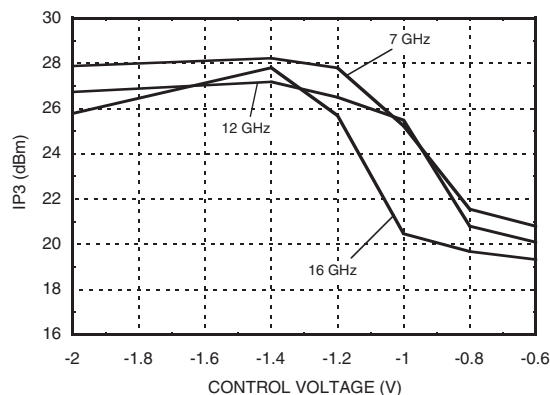

Information furnished by Analog Devices is believed to be accurate and reliable. However, no responsibility is assumed by Analog Devices for its use, nor for any infringements of patents or other rights of third parties that may result from its use. Specifications subject to change without notice. No license is granted by implication or otherwise under any patent or patent rights of Analog Devices. Trademarks and registered trademarks are the property of their respective owners.

For price, delivery, and to place orders: Analog Devices, Inc., One Technology Way, P.O. Box 9106, Norwood, MA 02062-9106 Phone: 781-329-4700 • Order online at www.analog.com Application Support: Phone: 1-800-ANALOG-D



GaAs MMIC ANALOG VARIABLE GAIN AMPLIFIER, 6 - 17 GHz

Absolute Maximum Ratings

Drain Bias Voltage (Vdd1, 2, 3)	+5.5V
Gate Bias Voltage (Vgg1, 2)	-3 to 0V
Gain Control Voltage (Vctrl)	-3 to 0V
RF Power Input	+5 dBm
Channel Temperature	175 °C
Continuous P _{diss} (T = 85 °C) (derate 10.2 mW/°C above 85 °C) [1]	0.92 W
Thermal Resistance (Channel to ground paddle)	97.6 °C/W
Storage Temperature	-65 to +150 °C
Operating Temperature	-40 to +85 °C

Bias Voltage

Vdd1,2,3 (V)	I _{dd} Total (mA)
+5.0	170
Vgg1,2 (V)	I _{gg} Total (mA)
0V to -2V	<3 μA



**ELECTROSTATIC SENSITIVE DEVICE
OBSERVE HANDLING PRECAUTIONS**

Outline Drawing

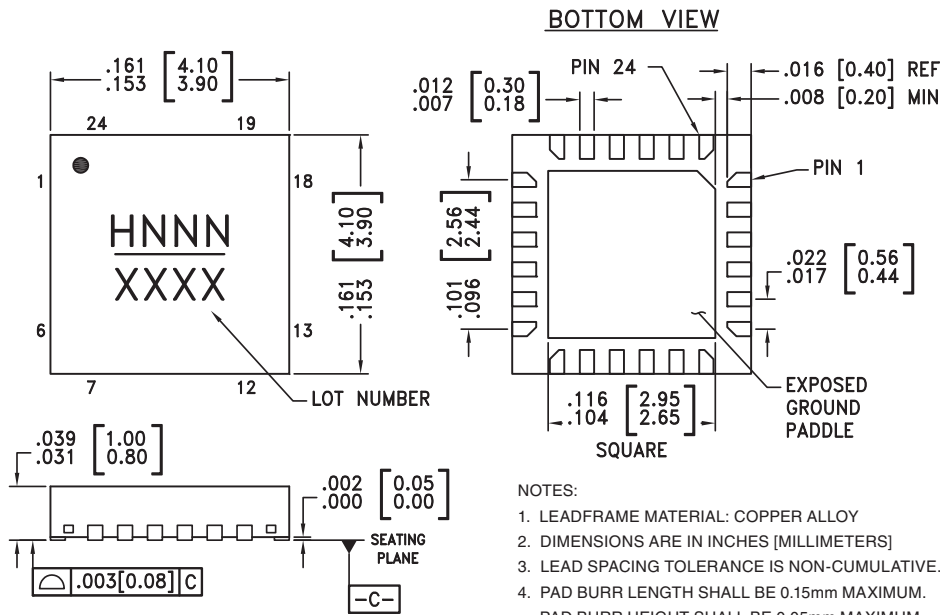

NOTES:

- LEADFRAME MATERIAL: COPPER ALLOY
- DIMENSIONS ARE IN INCHES [MILLIMETERS]
- LEAD SPACING TOLERANCE IS NON-CUMULATIVE.
- PAD BURR LENGTH SHALL BE 0.15mm MAXIMUM.
PAD BURR HEIGHT SHALL BE 0.05mm MAXIMUM.
- PACKAGE WARP SHALL NOT EXCEED 0.05mm.
- ALL GROUND LEADS AND GROUND PADDLE MUST BE SOLDERED TO PCB RF GROUND.
- REFER TO HITTITE APPLICATION NOTE FOR SUGGESTED LAND PATTERN.

Package Information

Part Number	Package Body Material	Lead Finish	MSL Rating	Package Marking [3]
HMC694LP4	Low Stress Injection Molded Plastic	Sn/Pb Solder	MSL1 [1]	H694 XXXX
HMC694LP4E	RoHS-compliant Low Stress Injection Molded Plastic	100% matte Sn	MSL1 [2]	H694 XXXX

[1] Max peak reflow temperature of 235 °C

[2] Max peak reflow temperature of 260 °C

[3] 4-Digit lot number XXXX

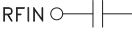
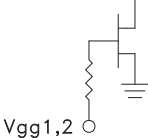
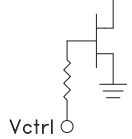
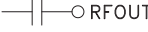
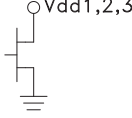

**GaAs MMIC ANALOG VARIABLE
GAIN AMPLIFIER, 6 - 17 GHz**
Pin Descriptions

Pad Number	Function	Description	Interface Schematic
1, 2, 6, 8, 10, 11, 13, 17, 18, 20, 21, 23	N/C	No Connection	
3, 5, 14, 16	GND	Die bottom must be connected to RF/DC ground.	
4	RFIN	This pad is AC coupled and matched to 50 Ohm.	
7, 12	Vgg1, 2	Gate control for amplifier. Adjust voltage to achieve typical I _{dd} . Please follow "MMIC Amplifier Biasing Procedure" application note.	
9	Vctrl	Gain control Voltage for the amplifier. See assembly diagram for required external components.	
15	RFOUT	This pad is AC coupled and matched to 50 Ohm.	
19, 22, 24	Vdd1, 2, 3	Drain Bias Voltage for the amplifier. See assembly diagram for required external components	

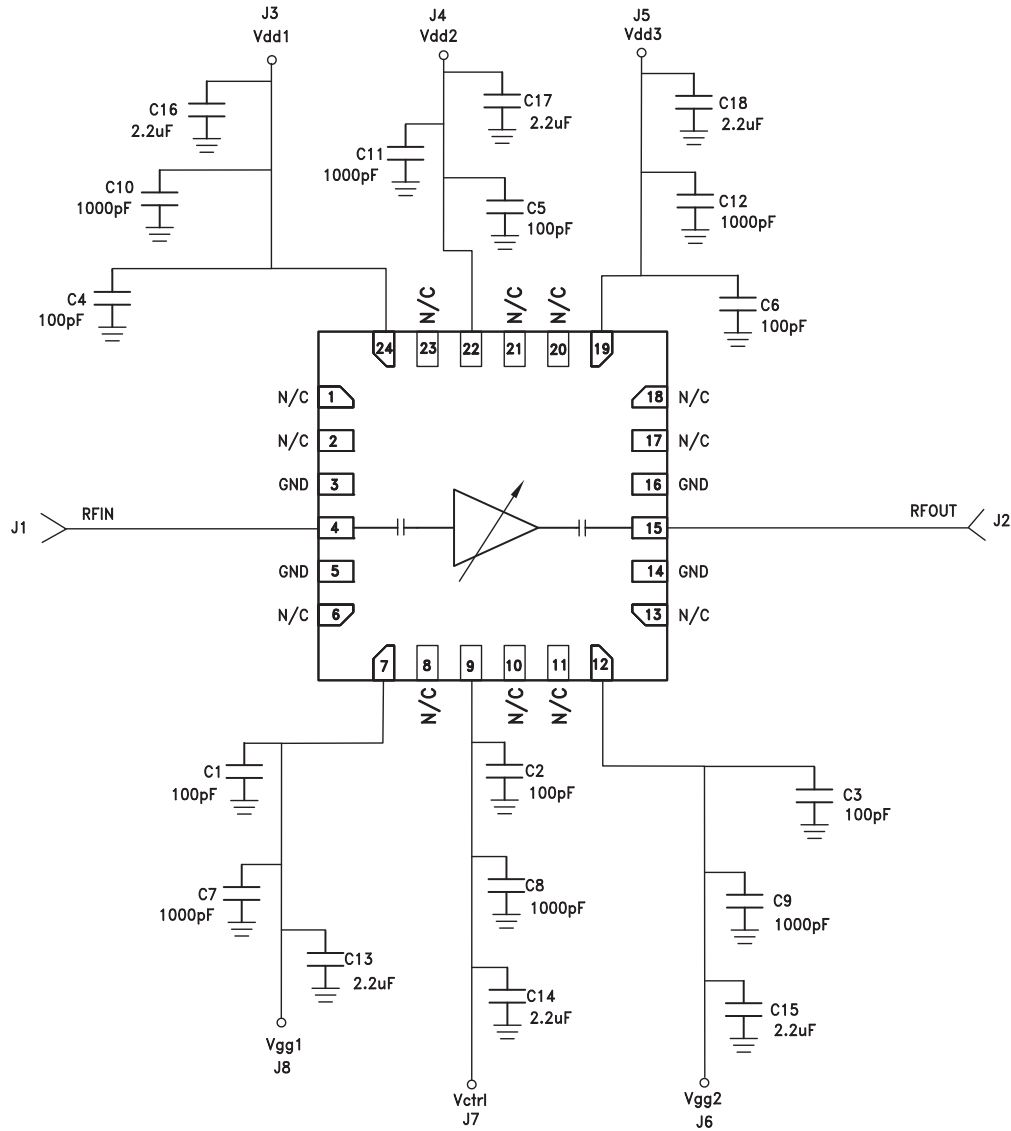

GaAs MMIC ANALOG VARIABLE GAIN AMPLIFIER, 6 - 17 GHz

Application Circuit



12

VARIABLE GAIN AMPLIFIERS - ANALOG - SMT

Information furnished by Analog Devices is believed to be accurate and reliable. However, no responsibility is assumed by Analog Devices for its use, nor for any infringements of patents or other rights of third parties that may result from its use. Specifications subject to change without notice. No license is granted by implication or otherwise under any patent or patent rights of Analog Devices. Trademarks and registered trademarks are the property of their respective owners.

For price, delivery, and to place orders: Analog Devices, Inc., One Technology Way, P.O. Box 9106, Norwood, MA 02062-9106 Phone: 781-329-4700 • Order online at www.analog.com Application Support: Phone: 1-800-ANALOG-D



Evaluation PCB

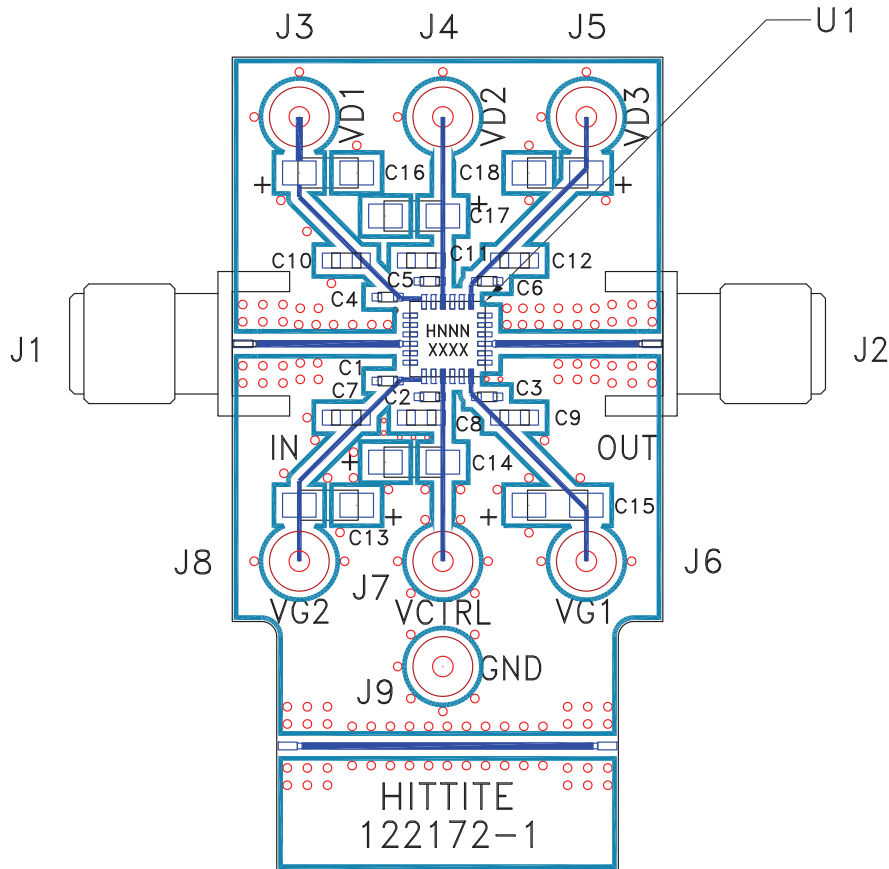

12

VARIABLE GAIN AMPLIFIERS - ANALOG - SMT

List of Materials for Evaluation PCB 122174 [1]

Item	Description
J1, J2	PCB Mount SMA RF Connectors
J3 - J9	DC Pin
C1 - C6	100 pF Capacitor, 0402 Pkg.
C7 - C12	1000 pF Capacitor, 0603 Pkg.
C13 - C18	2.2 μF Capacitor, CASE A
U1	HMC694LP4(E) Variable Gain Amplifier
PCB [2]	122172 Evaluation PCB

The circuit board used in the application should use RF circuit design techniques. Signal lines should have 50 Ohm impedance while the package ground leads and exposed paddle should be connected directly to the ground plane similar to that shown. A sufficient number of via holes should be used to connect the top and bottom ground planes. The evaluation circuit board shown is available from Hit-tite upon request.

[1] Reference this number when ordering complete evaluation PCB

[2] Circuit Board Material: Arlon 25FR