



Chipsmall Limited consists of a professional team with an average of over 10 year of expertise in the distribution of electronic components. Based in Hongkong, we have already established firm and mutual-benefit business relationships with customers from,Europe,America and south Asia,supplying obsolete and hard-to-find components to meet their specific needs.

With the principle of “Quality Parts,Customers Priority,Honest Operation,and Considerate Service”,our business mainly focus on the distribution of electronic components. Line cards we deal with include Microchip,ALPS,ROHM,Xilinx,Pulse,ON,Everlight and Freescale. Main products comprise IC,Modules,Potentiometer,IC Socket,Relay,Connector.Our parts cover such applications as commercial,industrial, and automotives areas.

We are looking forward to setting up business relationship with you and hope to provide you with the best service and solution. Let us make a better world for our industry!



Contact us

Tel: +86-755-8981 8866 Fax: +86-755-8427 6832

Email & Skype: info@chipsmall.com Web: www.chipsmall.com

Address: A1208, Overseas Decoration Building, #122 Zhenhua RD., Futian, Shenzhen, China





SMT GaAs HBT MMIC x4 ACTIVE FREQUENCY MULTIPLIER 11.4 - 13.2 GHz OUTPUT

Typical Applications

The HMC695LP4(E) is ideal for:

- Fiber Optic Applications
- Point-to-Point Radios
- Military Radar

Features

- Output Power: +7 dBm
- Sub-Harmonic Suppression: >25 dBc
- SSB Phase Noise: -140 dBc/Hz
- Single Supply: +5V @ 60 mA
- 24 Lead 4x4 mm SMT Package: 16 mm²

Functional Diagram

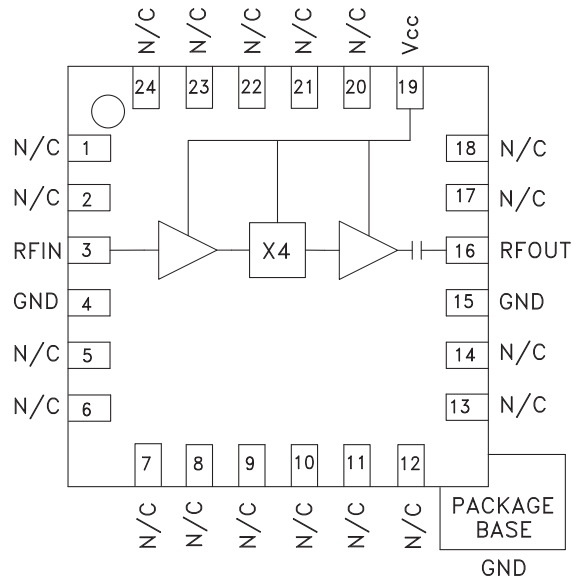

General Description

The HMC695LP4(E) are active miniature x4 frequency multipliers utilizing InGaP GaAs HBT technology in 4x4 mm leadless surface mount packages. Power output is +7 dBm typical from a +5V supply voltage and varies little vs. input power, temperature and supply voltage. Suppression of undesired fundamental and sub-harmonics is >25 dBc typical with respect to output signal level. The low additive SSB phase noise of -140 dBc/Hz at 100 kHz offset helps the user maintain good system noise performance. The HMC695LP4(E) are ideal for use in LO multiplier chains allowing reduced parts count vs. traditional approaches.

Electrical Specifications, $T_A = +25^\circ\text{C}$, $V_{CC} = 5V$

Parameter	Min.	Typ.	Max.	Units
Frequency Range, Input	2.85 - 3.3			GHz
Frequency Range, Output	11.4 - 13.2			GHz
Input Power Range	-15		5	dBm
Output Power	2	7		dBm
Sub-Harmonic Suppression		25		dBc
Input Return Loss		15		dB
Output Return Loss		8		dB
SSB Phase Noise (100 kHz Offset)	Pin= 0 dBm	-140		dBc/Hz
Supply Current (I _{CC})		60	75	mA

HMC695* PRODUCT PAGE QUICK LINKS

Last Content Update: 02/23/2017

COMPARABLE PARTS

View a parametric search of comparable parts.

EVALUATION KITS

- HMC695LP4 Evaluation Board

DOCUMENTATION

Data Sheet

- HMC695 Data Sheet

TOOLS AND SIMULATIONS

- HMC695 S-Parameter

REFERENCE MATERIALS

Quality Documentation

- Package/Assembly Qualification Test Report: LP4, LP4B, LP4C, LP4K (QTR: 2013-00487 REV: 04)
- Semiconductor Qualification Test Report: GaAs HBT-A (QTR: 2013-00228)

DESIGN RESOURCES

- HMC695 Material Declaration
- PCN-PDN Information
- Quality And Reliability
- Symbols and Footprints

DISCUSSIONS

View all HMC695 EngineerZone Discussions.

SAMPLE AND BUY

Visit the product page to see pricing options.

TECHNICAL SUPPORT

Submit a technical question or find your regional support number.

DOCUMENT FEEDBACK

Submit feedback for this data sheet.



SMT GaAs HBT MMIC x4 ACTIVE FREQUENCY MULTIPLIER 11.4 - 13.2 GHz OUTPUT

Output Power vs. Temperature @ -10 dBm Drive Level

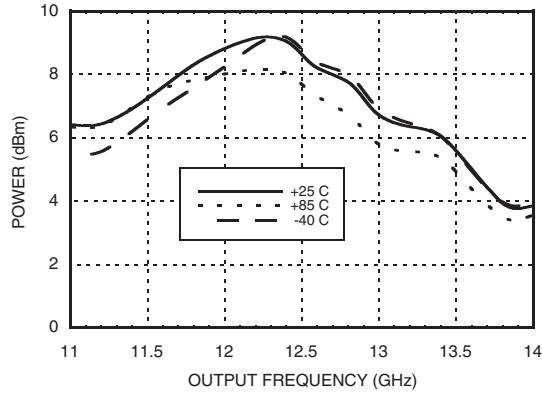

Output Power vs. Drive Level

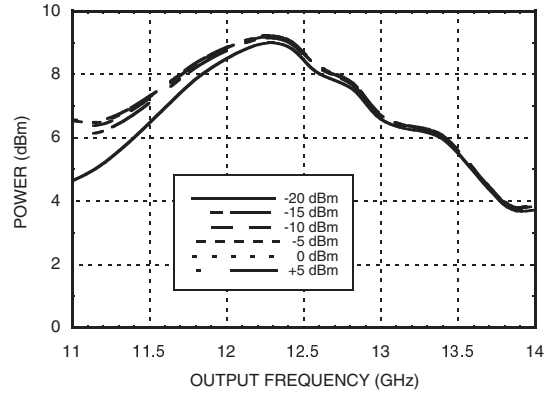

Output Power vs. Supply Voltage @ -10 dBm Drive Level

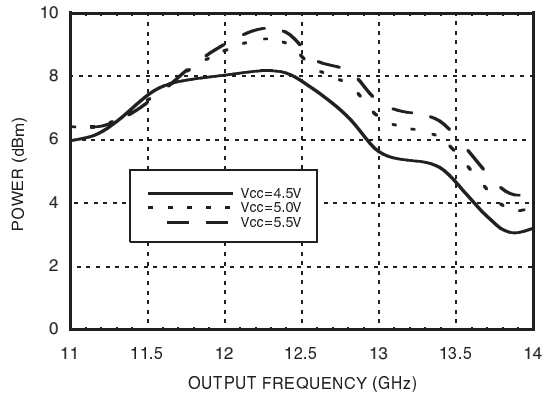

Input Return Loss vs. Temperature

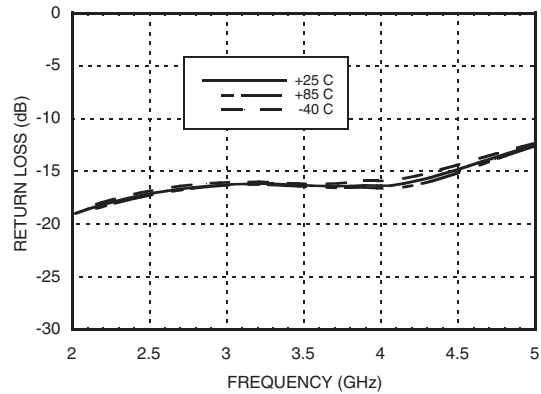

Output Return Loss vs. Temperature

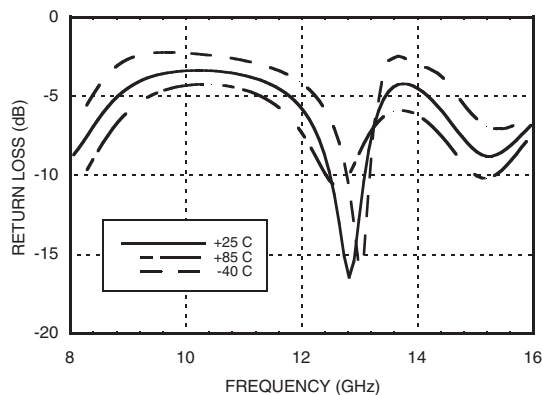

Harmonics @ -10 dBm Drive Level

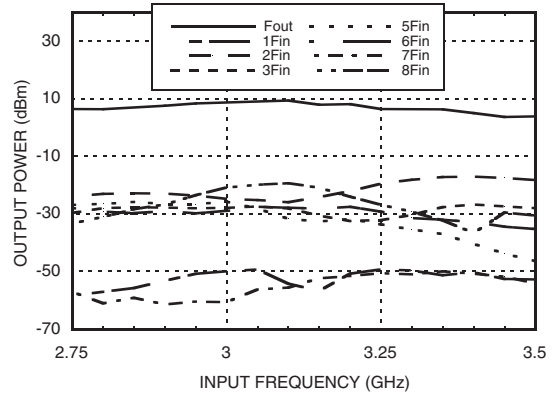

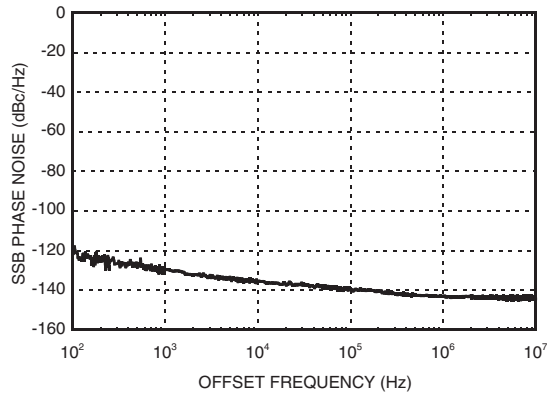
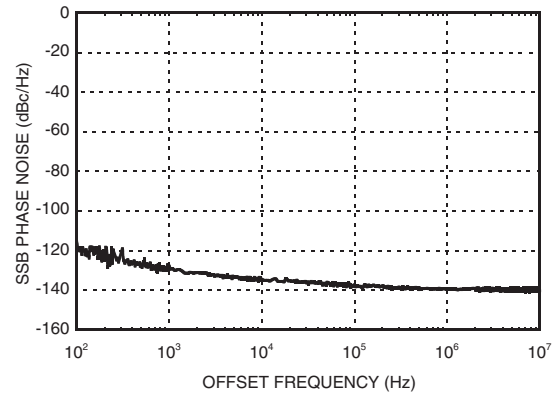
**SMT GaAs HBT MMIC x4 ACTIVE FREQUENCY MULTIPLIER
11.4 - 13.2 GHz OUTPUT**
SSB Phase Noise
@ Pin = 0 dBm @ 12.5 GHz

SSB Phase Noise
@ Pin = -10 dBm @ 12.5 GHz

Absolute Maximum Ratings

RF Input (Vcc= +5V)	+20 dBm
Vcc	+5.5V
Channel Temperature	135 °C
Continuous Pdiss (T=85 °C) (derate 10.8 mW/°C above 85 °C)	538 mW
Thermal Resistance (R _{thj}) (junction to ground paddle)	93 °C/W
Storage Temperature	-65 to +150 °C
Operating Temperature	-40 to +85 °C
ESD Sensitivity (HBM)	Class 1B

Typical Supply Current vs. Vcc

Vcc (V)	Icc (mA)
4.75	59
5.00	60
5.25	61

Note: Multiplier will operate over full voltage range shown above.



**ELECTROSTATIC SENSITIVE DEVICE
OBSERVE HANDLING PRECAUTIONS**

SMT GaAs HBT MMIC x4 ACTIVE FREQUENCY MULTIPLIER 11.4 - 13.2 GHz OUTPUT

Outline Drawing

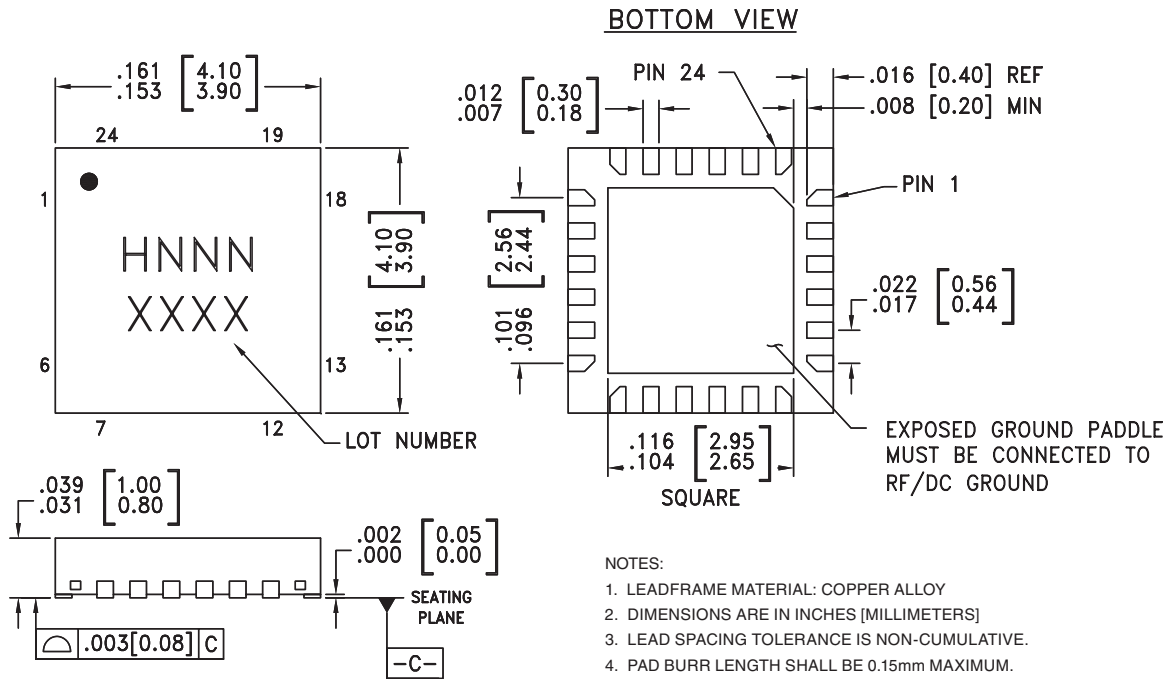

Package Information



Part Number	Package Body Material	Lead Finish	MSL Rating	Package Marking ^[3]
HMC695LP4	Low Stress Injection Molded Plastic	Sn/Pb Solder	MSL1 ^[1]	H695 XXXX
HMC695LP4E	RoHS-compliant Low Stress Injection Molded Plastic	100% matte Sn	MSL1 ^[2]	H695 XXXX

[1] Max peak reflow temperature of 235 °C

[2] Max peak reflow temperature of 260 °C

[3] 4-Digit lot number XXXX

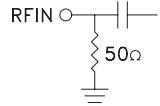

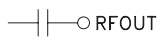
**SMT GaAs HBT MMIC x4 ACTIVE FREQUENCY MULTIPLIER
11.4 - 13.2 GHz OUTPUT**
Pin Description

Pin Number	Function	Description	Interface Schematic
1, 2, 5 - 14, 17, 18, 20 - 24	N/C	The pins are not connected internally; however, all data shown herein was measured with these pins connected to RF/DC ground externally.	
3	RFIN	RF input needs to be DC blocked only if there is an external DC voltage applied to RFIN.	
4, 15	GND	All ground leads and ground paddle must be soldered to PCB RF/DC ground.	
16	RFOUT	Multiplied Output. AC coupled. No external DC blocks necessary.	
19	Vcc	Supply voltage 5V	

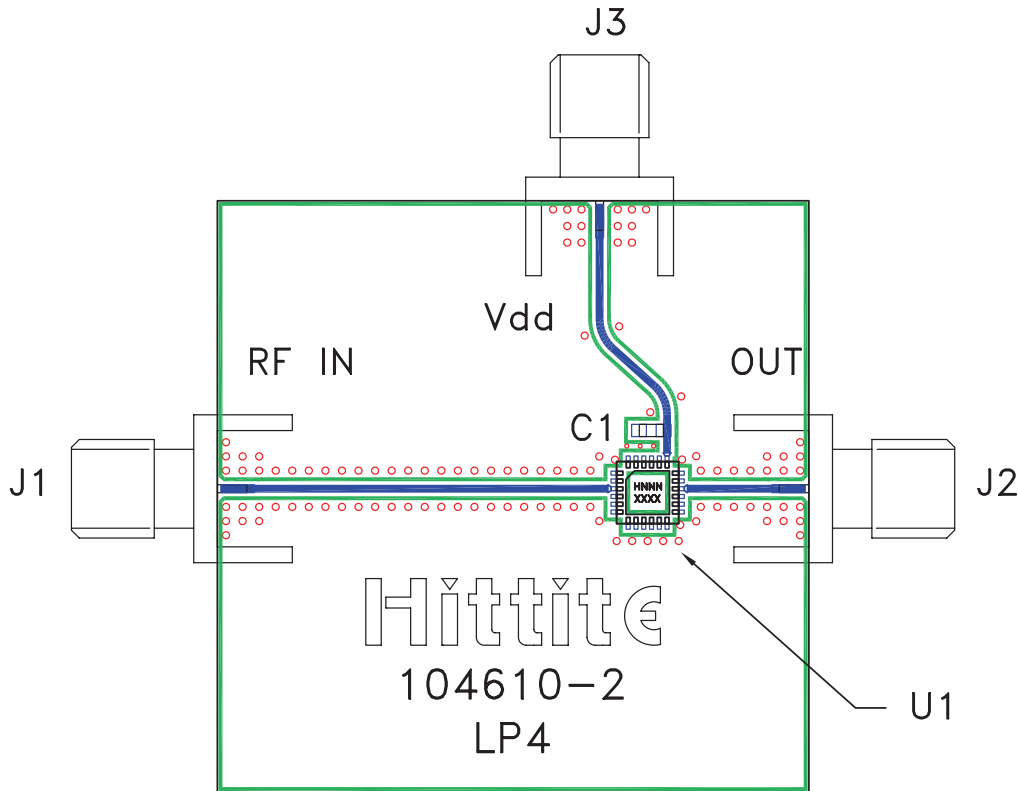

**SMT GaAs HBT MMIC x4 ACTIVE FREQUENCY MULTIPLIER
11.4 - 13.2 GHz OUTPUT**

Evaluation PCB



List of Materials for Evaluation PCB 106137 [1]

Item	Description
J1 - J3	PCB Mount SMA Connector
C1	1,000 pF Capacitor, 0603 Pkg.
U1	HMC695LP4(E) x4 Active Multiplier
PCB [2]	104610 Eval Board

[1] Reference this number when ordering complete evaluation PCB

[2] Circuit Board Material: Arlon 25FR or Rogers 4350

The circuit board used in the application should be generated with proper RF circuit design techniques. Signal lines should have 50 ohm impedance while the package ground leads and exposed paddle should be connected directly to the ground plane similar to that shown. The evaluation circuit board shown is available from Hittite upon request.