



Chipsmall Limited consists of a professional team with an average of over 10 year of expertise in the distribution of electronic components. Based in Hongkong, we have already established firm and mutual-benefit business relationships with customers from,Europe,America and south Asia,supplying obsolete and hard-to-find components to meet their specific needs.

With the principle of “Quality Parts,Customers Priority,Honest Operation,and Considerate Service”,our business mainly focus on the distribution of electronic components. Line cards we deal with include Microchip,ALPS,ROHM,Xilinx,Pulse,ON,Everlight and Freescale. Main products comprise IC,Modules,Potentiometer,IC Socket,Relay,Connector.Our parts cover such applications as commercial,industrial, and automotives areas.

We are looking forward to setting up business relationship with you and hope to provide you with the best service and solution. Let us make a better world for our industry!



Contact us

Tel: +86-755-8981 8866 Fax: +86-755-8427 6832

Email & Skype: info@chipsmall.com Web: www.chipsmall.com

Address: A1208, Overseas Decoration Building, #122 Zhenhua RD., Futian, Shenzhen, China



GaAs PHEMT MMIC LOW NOISE AMPLIFIER, 2.1 - 2.9 GHz



Typical Applications

The HMC715LP3(E) is ideal for:

- Cellular/3G and LTE/WiMAX/4G
- BTS & Infrastructure
- Repeaters and Femtocells
- Public Safety Radio
- Access Points

Features

- Noise Figure: 0.9 dB
- Gain: 19 dB
- Output IP3: +33 dBm
- Single Supply: +3V to +5V
- 16 Lead 3x3mm QFN Package: 9 mm²

Functional Diagram

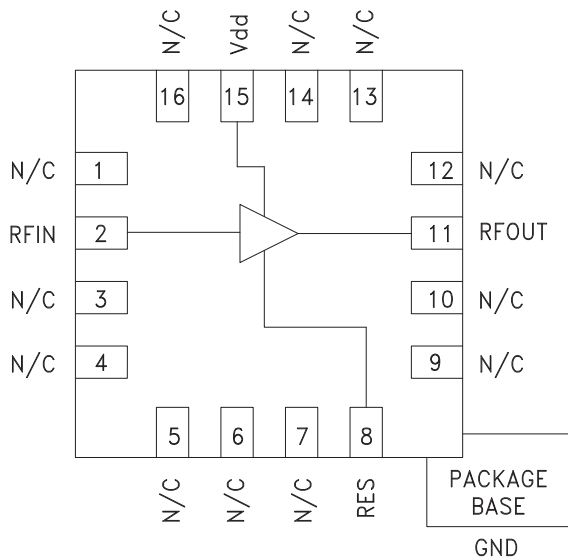

General Description

The HMC715LP3(E) is a GaAs PHEMT MMIC Low Noise Amplifier that is ideal for Cellular/3G and LTE/WiMAX/4G basestation front-end receivers operating between 2.1 and 2.9 GHz. The amplifier has been optimized to provide 0.9 dB noise figure, 19 dB gain and +33 dBm output IP3 from a single supply of +5V. Input and output return losses are excellent and the LNA requires minimal external matching and bias decoupling components. The HMC715LP3(E) can be biased with +3V to +5V and features an externally adjustable supply current which allows the designer to tailor the linearity performance of the LNA for each application.

Electrical Specifications

$T_A = +25^\circ\text{C}$, $R_{bias} = 2k\ \text{Ohms}$ for $V_{dd} = +5V$, $R_{bias} = 47k\ \text{Ohms}$ for $V_{dd} = +3V$ [1]

Parameter	Vdd = +3V			Vdd = +5V			Vdd = +3V			Vdd = +5V			Units
	Min.	Typ.	Max.	Min.	Typ.	Max.	Min.	Typ.	Max.	Min.	Typ.	Max.	
Frequency Range	2.1 - 2.9			2.3 - 2.7			2.1 - 2.9			2.3 - 2.7			MHz
Gain	14.5	18		15	18		15.5	19		16.5	19		dB
Gain Variation Over Temperature		0.01			0.01			0.01			0.01		dB/°C
Noise Figure		0.9	1.2		0.9	1.2		0.9	1.2		0.9	1.2	dB
Input Return Loss		11.5			11			11.5			11		dB
Output Return Loss		14			13.5			12.5			12		dB
Output Power for 1 dB Compression (P1dB)	10.5	14.5		12.5	15		15	19		16.5	19.5		dBm
Saturated Output Power (Psat)		16			16.5			20			20.5		dBm
Output Third Order Intercept (IP3)		28			28.5			33			33.5		dBm
Supply Current (Idd)		47	65		47	65		95	126		95	126	mA

[1] Rbias resistor sets current, see application circuit herein

HMC715* PRODUCT PAGE QUICK LINKS

Last Content Update: 02/23/2017

COMPARABLE PARTS

View a parametric search of comparable parts.

EVALUATION KITS

- HMC715LP3 Evaluation Board

DOCUMENTATION

Data Sheet

- HMC715 Data Sheet

TOOLS AND SIMULATIONS

- HMC715 S-Parameter

REFERENCE MATERIALS

Quality Documentation

- Package/Assembly Qualification Test Report: LP2, LP2C, LP3, LP3B, LP3C, LP3D, LP3F, LP3G (QTR: 2014-0364)
- Semiconductor Qualification Test Report: PHEMT-D (QTR: 2013-00254)

DESIGN RESOURCES

- HMC715 Material Declaration
- PCN-PDN Information
- Quality And Reliability
- Symbols and Footprints

DISCUSSIONS

View all HMC715 EngineerZone Discussions.

SAMPLE AND BUY

Visit the product page to see pricing options.

TECHNICAL SUPPORT

Submit a technical question or find your regional support number.

DOCUMENT FEEDBACK

Submit feedback for this data sheet.



**GaAs PHEMT MMIC LOW NOISE
AMPLIFIER, 2.1 - 2.9 GHz**

Broadband Gain & Return Loss [1] [2]

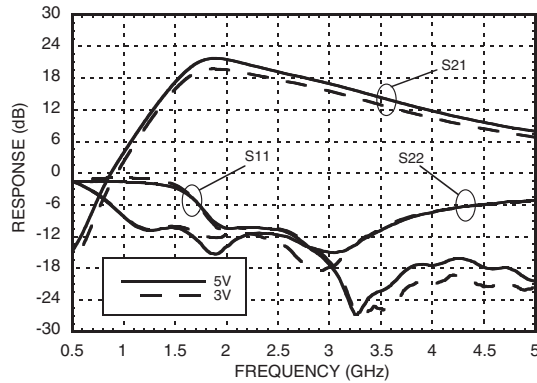

Gain vs. Temperature [1]

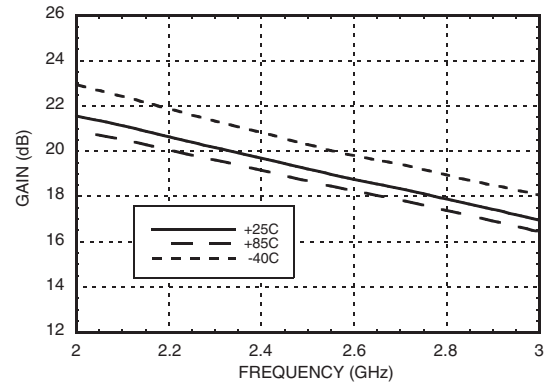

Gain vs. Temperature [2]

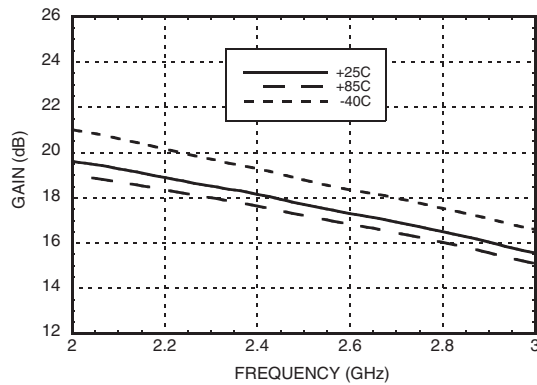

Input Return Loss vs. Temperature [1]

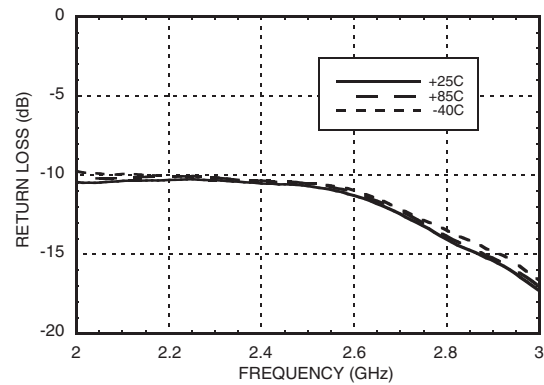

Output Return Loss vs. Temperature [1]

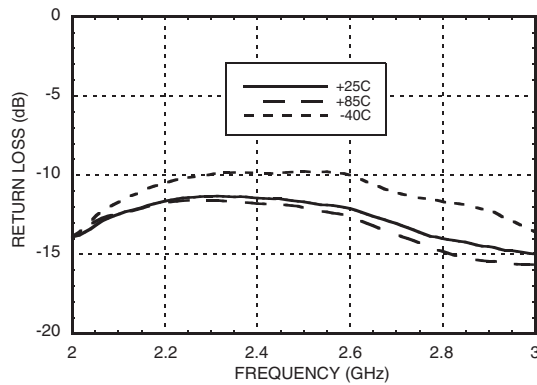

Reverse Isolation vs. Temperature [1]

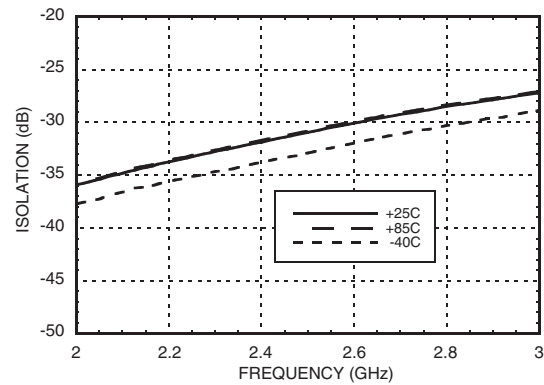

[1] Vdd = 5V, Rbias = 2kΩ [2] Vdd = 3V, Rbias = 47kΩ

Information furnished by Analog Devices is believed to be accurate and reliable. However, no responsibility is assumed by Analog Devices for its use, nor for any infringements of patents or other rights of third parties that may result from its use. Specifications subject to change without notice. No license is granted by implication or otherwise under any patent or patent rights of Analog Devices. Trademarks and registered trademarks are the property of their respective owners.

For price, delivery, and to place orders: Analog Devices, Inc., One Technology Way, P.O. Box 9106, Norwood, MA 02062-9106 Phone: 781-329-4700 • Order online at www.analog.com Application Support: Phone: 1-800-ANALOG-D



HMC715LP3 / 715LP3E

GaAs PHEMT MMIC LOW NOISE AMPLIFIER, 2.1 - 2.9 GHz

Noise Figure vs. Temperature [1] [2] [4]

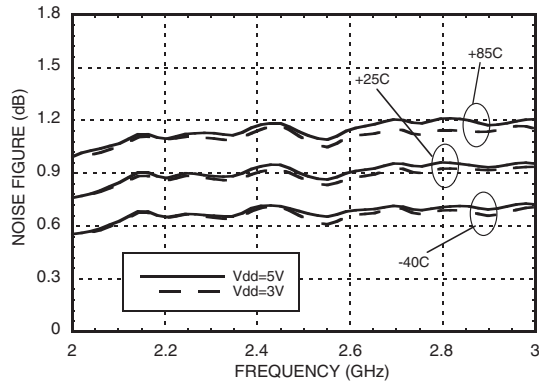

P1dB vs. Temperature [1] [2]

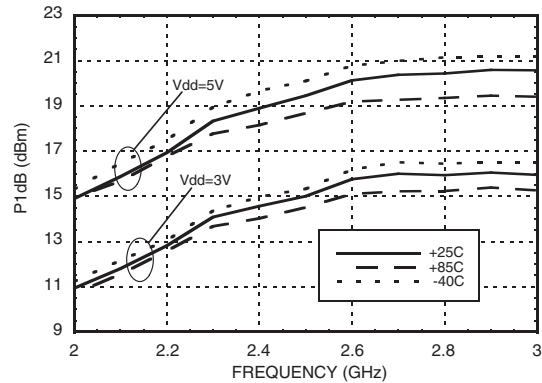

Psat vs. Temperature [1] [2]

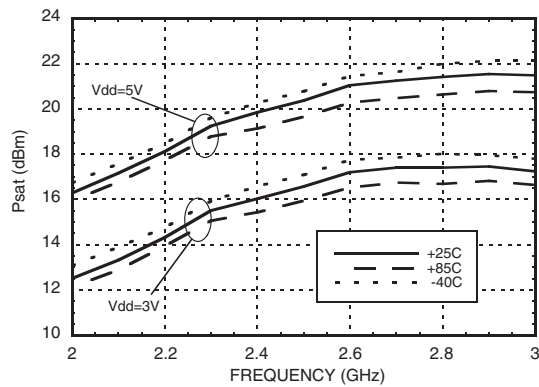

Output IP3 vs. Temperature [1] [2]

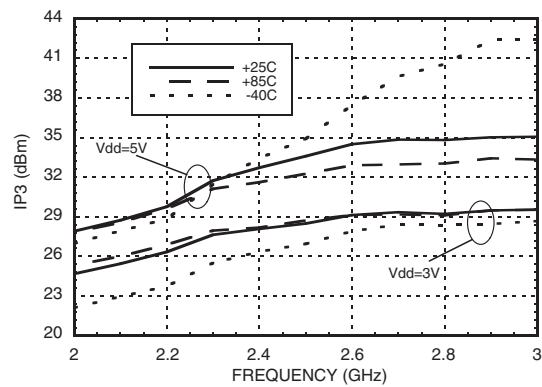

Output IP3 and Supply Current vs. Supply Voltage @ 2300 MHz [3]

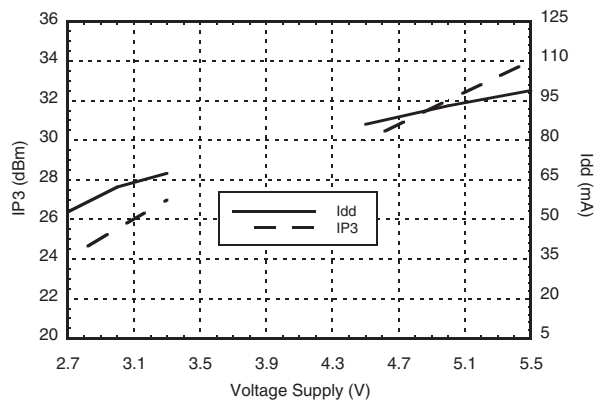

Output IP3 and Supply Current vs. Supply Voltage @ 2700 MHz [3]

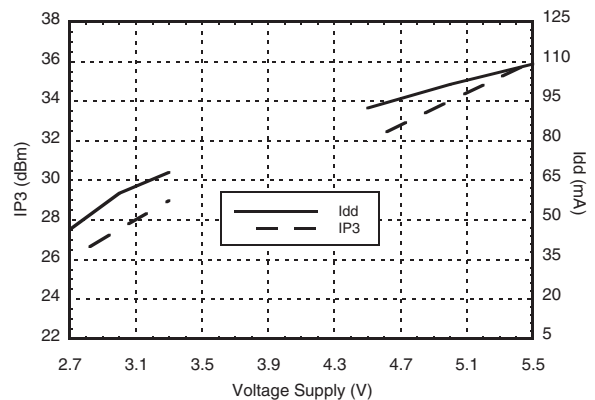

[1] Vdd = 5V, Rbias = 2kΩ [2] Vdd = 3V, Rbias = 47kΩ

[3] Rbias = 2kΩ for Vdd = 5V, Rbias = 47kΩ for Vdd = 3V [4] Measurement reference plane shown on evaluation PCB drawing.



GaAs PHEMT MMIC LOW NOISE AMPLIFIER, 2.1 - 2.9 GHz

Power Compression @ 2300 MHz [1]

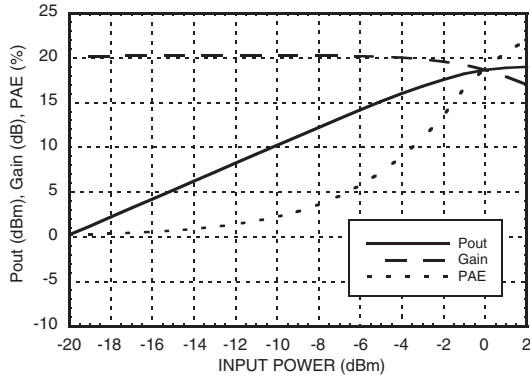

Power Compression @ 2300 MHz [2]

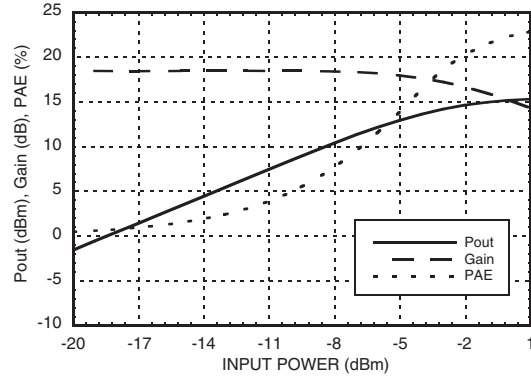

Power Compression @ 2700 MHz [1]

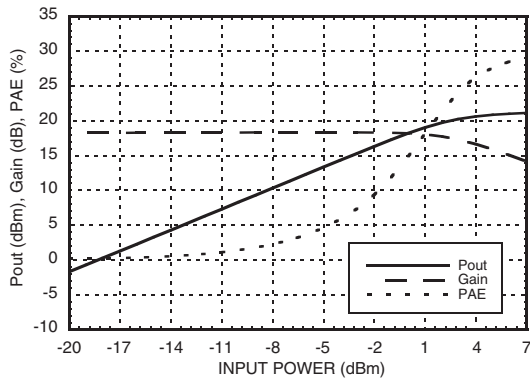

Power Compression @ 2700 MHz [2]

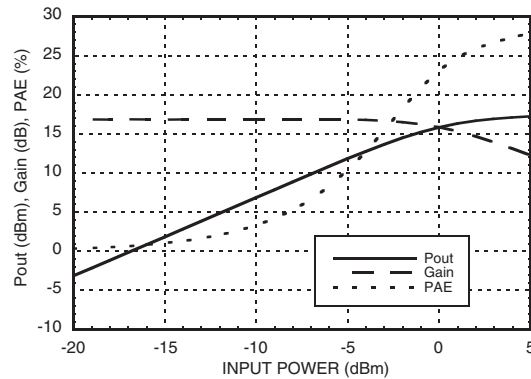

Gain, Power & Noise Figure vs. Supply Voltage @ 2300 MHz [3]

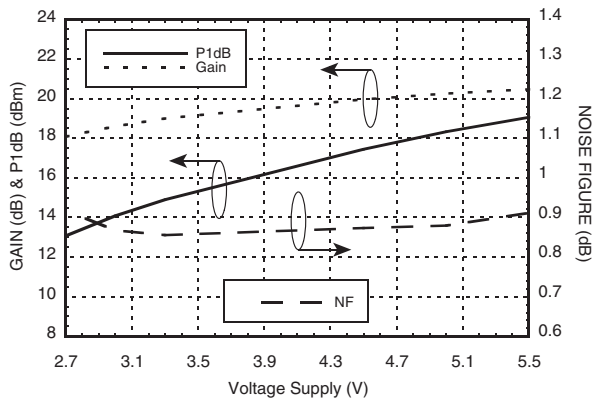

Gain, Power & Noise Figure vs. Supply Voltage @ 2700 MHz [3]

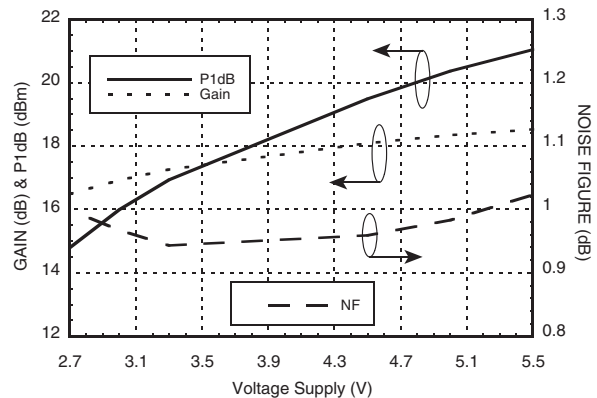

[1] Vdd = 5V, Rbias = 2kΩ [2] Vdd = 3V, Rbias = 47kΩ [3] Rbias = 2kΩ for Vdd = 5V, Rbias = 47kΩ for Vdd = 3V

Information furnished by Analog Devices is believed to be accurate and reliable. However, no responsibility is assumed by Analog Devices for its use, nor for any infringements of patents or other rights of third parties that may result from its use. Specifications subject to change without notice. No license is granted by implication or otherwise under any patent or patent rights of Analog Devices. Trademarks and registered trademarks are the property of their respective owners.

For price, delivery, and to place orders: Analog Devices, Inc., One Technology Way, P.O. Box 9106, Norwood, MA 02062-9106 Phone: 781-329-4700 • Order online at www.analog.com Application Support: Phone: 1-800-ANALOG-D



HMC715LP3 / 715LP3E

**GaAs PHEMT MMIC LOW NOISE
AMPLIFIER, 2.1 - 2.9 GHz**

7

AMPLIFIERS - LOW NOISE - SMT

Output IP3 vs. Rbias @ 2300 MHz

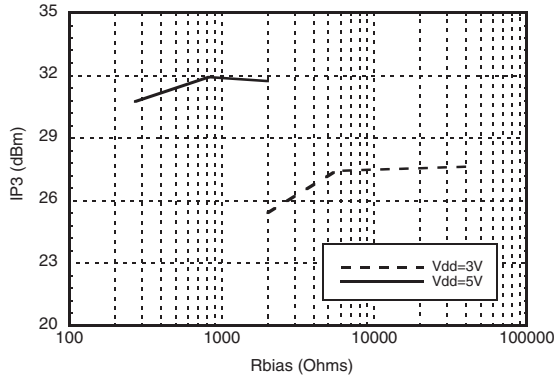

Gain, Noise Figure & Rbias @ 2300 MHz

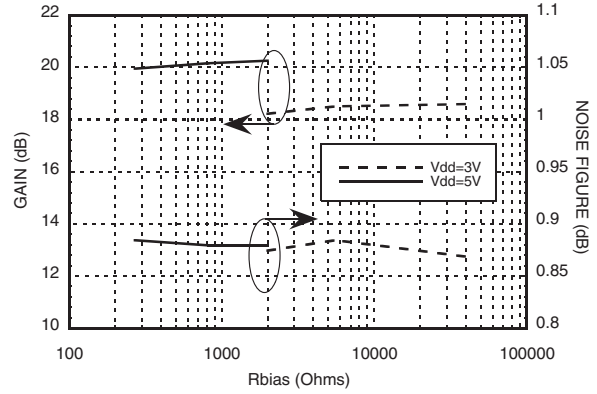

Output IP3 vs. Rbias @ 2700 MHz

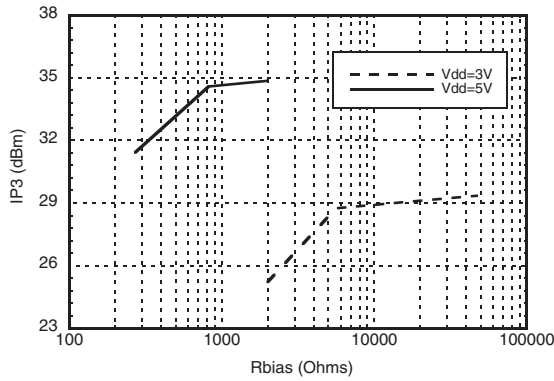

Gain, Noise Figure & Rbias @ 2700 MHz

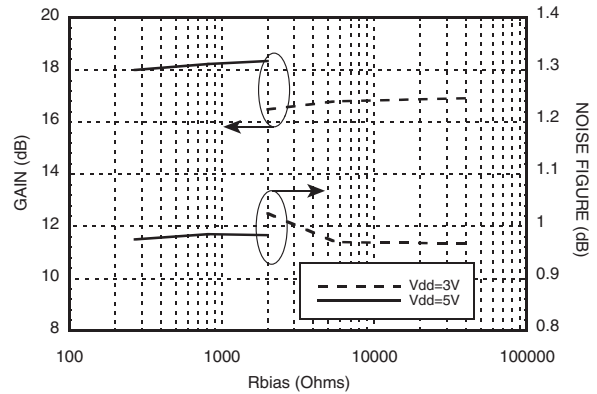

Information furnished by Analog Devices is believed to be accurate and reliable. However, no responsibility is assumed by Analog Devices for its use, nor for any infringements of patents or other rights of third parties that may result from its use. Specifications subject to change without notice. No license is granted by implication or otherwise under any patent or patent rights of Analog Devices. Trademarks and registered trademarks are the property of their respective owners.

For price, delivery, and to place orders: Analog Devices, Inc., One Technology Way, P.O. Box 9106, Norwood, MA 02062-9106 Phone: 781-329-4700 • Order online at www.analog.com Application Support: Phone: 1-800-ANALOG-D

**Absolute Bias Resistor
Range & Recommended Bias Resistor Values**

Vdd (V)	Rbias (Ohms)			Idd (mA)
	Min	Max	Recommended	
3V	1.8k [1]	Open Circuit	2K	28
			5.6K	40
			47K	47
5V	0	Open Circuit	270	61
			820	81
			2K	95

[1] With Vdd= 3V and Rbias < 1.8k Ohms may result in the part becoming conditionally stable which is not recommended.

Absolute Maximum Ratings

Drain Bias Voltage (Vdd)	+5.5V
RF Input Power (RFIN) (Vdd = +5 Vdc)	+10 dBm
Channel Temperature	150 °C
Continuous Pdiss (T= 85 °C) (derate 11.1 mW/°C above 85 °C)	0.72 W
Thermal Resistance (channel to ground paddle)	90 °C/W
Storage Temperature	-65 to +150 °C
Operating Temperature	-40 to +85 °C
ESD Sensitivity (HBM)	Class 1A



**ELECTROSTATIC SENSITIVE DEVICE
OBSERVE HANDLING PRECAUTIONS**

Typical Supply Current vs. Supply Voltage

(Rbias = 2k for Vdd = 5V, Rbias = 47k for Vdd = 3V)

Vdd (V)	Idd (mA)
2.7	35
3.0	47
3.3	57
4.5	80
5.0	95
5.5	110

Note: Amplifier will operate over full voltage ranges shown above.



Outline Drawing

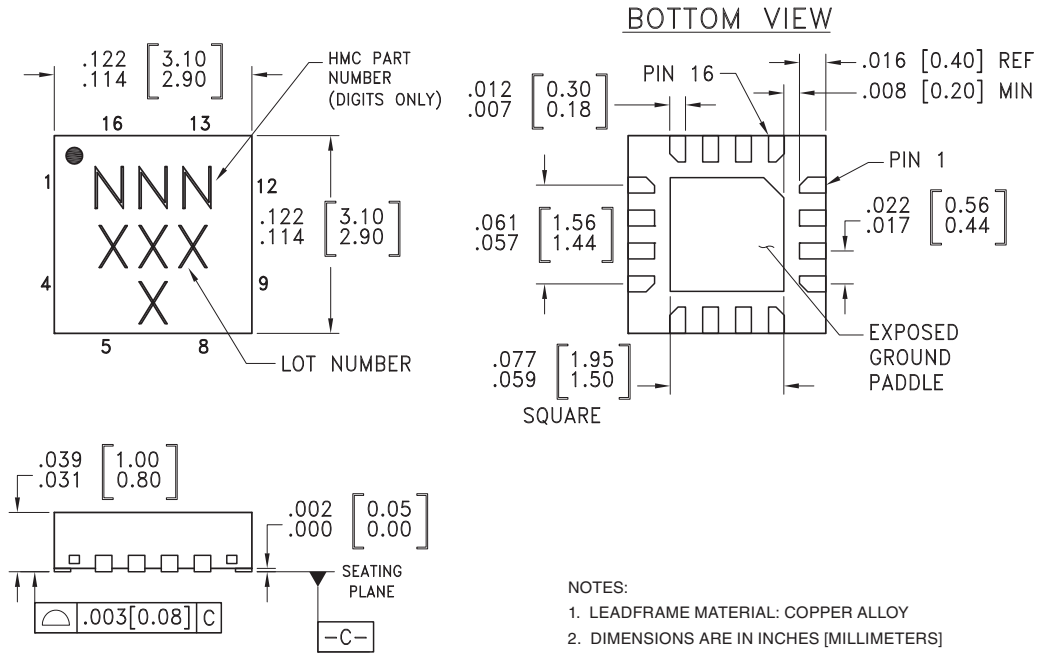



- NOTES:
1. LEADFRAME MATERIAL: COPPER ALLOY
 2. DIMENSIONS ARE IN INCHES [MILLIMETERS]
 3. LEAD SPACING TOLERANCE IS NON-CUMULATIVE
 4. PAD BURR LENGTH SHALL BE 0.15mm MAXIMUM. PAD BURR HEIGHT SHALL BE 0.05mm MAXIMUM.
 5. PACKAGE WARP SHALL NOT EXCEED 0.05mm.
 6. ALL GROUND LEADS AND GROUND PADDLE MUST BE SOLDERED TO PCB RF GROUND.
 7. REFER TO HITTITE APPLICATION NOTE FOR SUGGESTED LAND PATTERN.

Package Information

Part Number	Package Body Material	Lead Finish	MSL Rating	Package Marking [3]
HMC715LP3	Low Stress Injection Molded Plastic	Sn/Pb Solder	MSL1 [1]	715 XXXX
HMC715LP3E	RoHS-compliant Low Stress Injection Molded Plastic	100% matte Sn	MSL1 [2]	715 XXXX

[1] Max peak reflow temperature of 235 °C
 [2] Max peak reflow temperature of 260 °C
 [3] 4-Digit lot number XXXX

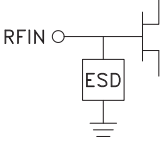
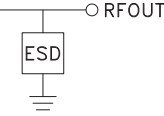
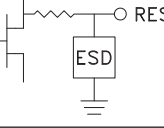
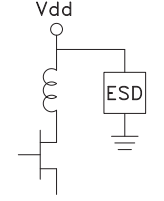

Pin Descriptions

Pin Number	Function	Description	Interface Schematic
1, 3 - 7, 9, 10, 12 - 14, 16	N/C	No connection required. These pins may be connected to RF/DC ground without affecting performance.	
2	RFIN	This pin is DC coupled. See application circuit for off chip component.	
11	RFOUT	This pin is DC coupled. See application circuit for off chip component.	
8	RES	This pin is used to set the DC current of the amplifier by selection of external bias resistor. See application circuit.	
15	Vdd	Power supply voltage. Bypass capacitors are required. See application circuit.	
	GND	Ground paddle must be connected to RF/DC ground.	

**GaAs PHEMT MMIC LOW NOISE
AMPLIFIER, 2.1 - 2.9 GHz**

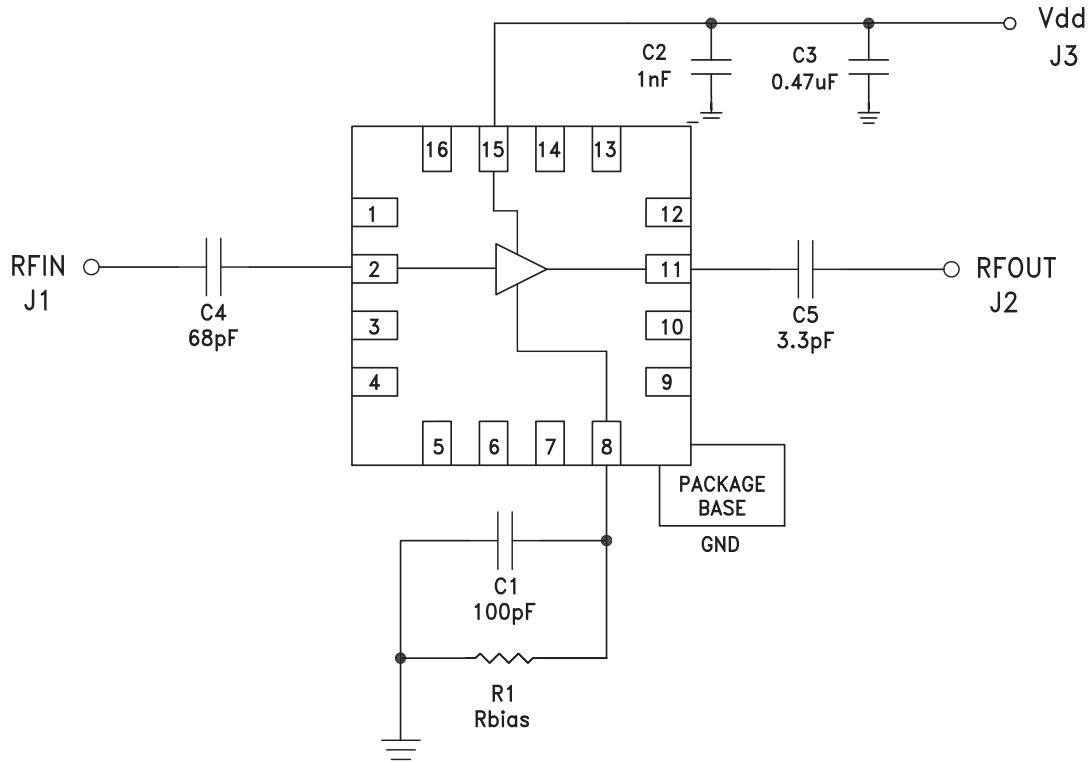

Application Circuit





Evaluation PCB

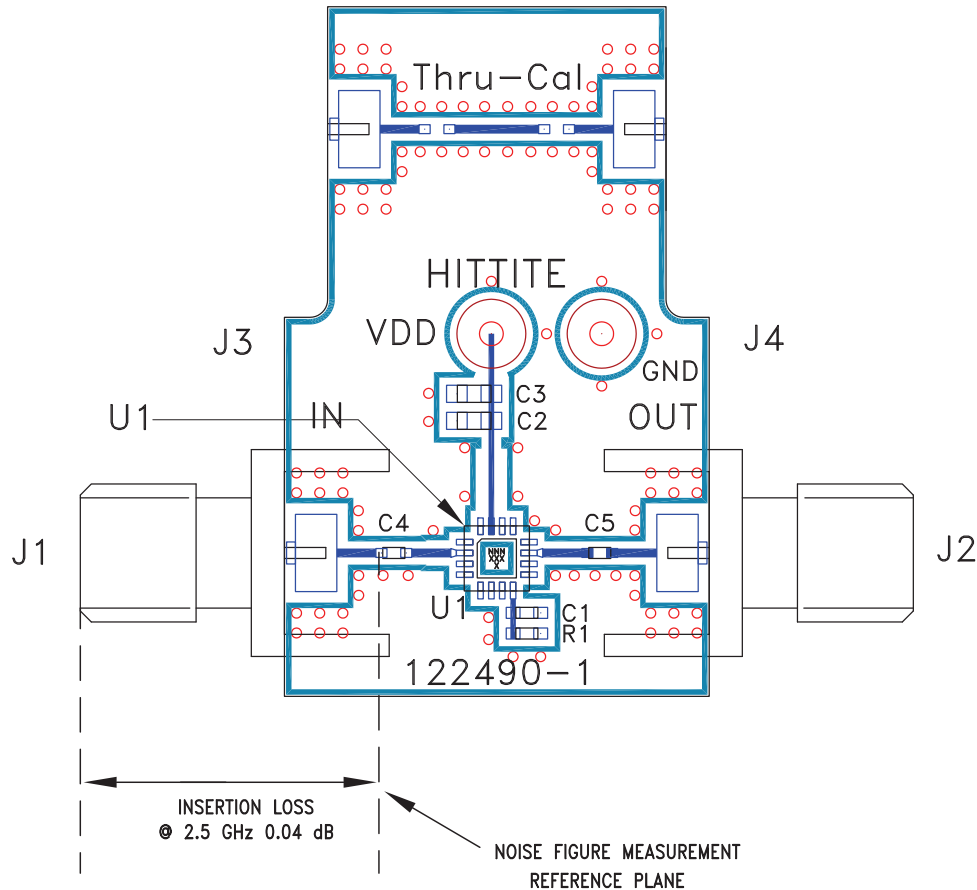

List of Materials for Evaluation PCB 122492 [1]

Item	Description
J1, J2	PCB Mount SMA RF Connector
J3, J4	DC Pin
C1	100pF Capacitor, 0402 Pkg.
C2	1000 pF Capacitor, 0603 Pkg.
C3	0.47µF Capacitor, 0603 Pkg.
C4	68pF Capacitor, 0402 Pkg.
C5	3.3pF Capacitor, 0402 Pkg.
R1	2kΩ Resistor, 0402 Pkg.
U1	HMC715LP3(E) Amplifier
PCB [2]	122490 Evaluation PCB

[1] Reference this number when ordering complete evaluation PCB

[2] Circuit Board Material: Rogers 4350. or Arlon 25R

The circuit board used in this application should use RF circuit design techniques. Signal lines should have 50 Ohm impedance while the package ground leads and exposed paddle should be connected directly to the ground plane similar to that shown. A sufficient number of via holes should be used to connect the top and bottom ground planes. The evaluation board should be mounted to an appropriate heat sink. The evaluation circuit board shown is available from Hittite upon request.