



Chipsmall Limited consists of a professional team with an average of over 10 year of expertise in the distribution of electronic components. Based in Hongkong, we have already established firm and mutual-benefit business relationships with customers from,Europe,America and south Asia,supplying obsolete and hard-to-find components to meet their specific needs.

With the principle of “Quality Parts,Customers Priority,Honest Operation,and Considerate Service”,our business mainly focus on the distribution of electronic components. Line cards we deal with include Microchip,ALPS,ROHM,Xilinx,Pulse,ON,Everlight and Freescale. Main products comprise IC,Modules,Potentiometer,IC Socket,Relay,Connector.Our parts cover such applications as commercial,industrial, and automotives areas.

We are looking forward to setting up business relationship with you and hope to provide you with the best service and solution. Let us make a better world for our industry!



Contact us

Tel: +86-755-8981 8866 Fax: +86-755-8427 6832

Email & Skype: info@chipsmall.com Web: www.chipsmall.com

Address: A1208, Overseas Decoration Building, #122 Zhenhua RD., Futian, Shenzhen, China





GaAs PHEMT MMIC HIGH IP3 LOW NOISE AMPLIFIER, 0.6 - 1.4 GHz

7

AMPLIFIERS - LOW NOISE - SMT

Typical Applications

The HMC718LP4(E) is ideal for:

- Cellular/3G and LTE/WiMAX/4G
- BTS & Infrastructure
- Repeaters and Femtocells
- Access Points
- Test Equipment

Features

- Noise Figure: 0.9 dB
- Gain: 32 dB
- Output IP3: +40 dBm
- Single Supply: +3V to +5V
- 50 Ohm Matched Input/Output
- 24 Lead 4x4 mm SMT Package: 16 mm²

Functional Diagram

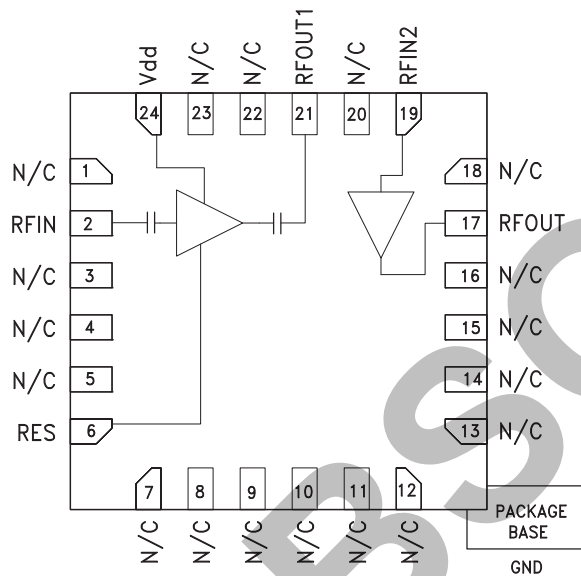

General Description

The HMC718LP4(E) is a GaAs PHEMT MMIC Low Noise Amplifier that is ideal for Cellular/3G and LTE/WiMAX/4G basestation front-end receivers operating between 600 and 1400 MHz. The amplifier has been optimized to provide 0.9 dB noise figure, 32 dB gain and +40 dBm output IP3 from a single supply of +5V. Input and output return losses are excellent and the LNA requires minimal external matching and bias decoupling components. The HMC718LP4(E) shares the same package and pinout with the HMC719LP3(E) 1.3 - 2.9 GHz LNA. The HMC718LP4(E) can be biased with +3V to +5V and features an externally adjustable supply current which allows the designer to tailor the linearity performance of the LNA for each application.

Electrical Specifications, $T_A = +25^\circ\text{C}$, $R_{\text{bias}} = 3.92\text{k Ohms}^*$

Parameter	Vdd = +3V			Vdd = +5V			Vdd = +3V			Vdd = +5V			Units
	Min.	Typ.	Max.	Min.	Typ.	Max.	Min.	Typ.	Max.	Min.	Typ.	Max.	
Frequency Range	0.6 - 1.0			1.0 - 1.4			0.6 - 1.0			1.0 - 1.4			GHz
Gain	26	30.5		25	27.5		27	32		25	29		dB
Gain Variation Over Temperature	0.01			0.01			0.01			0.01			dB/°C
Noise Figure	0.95			0.75			0.95			0.8			dB
Input Return Loss	15			20			15.5			23			dB
Output Return Loss	13			10			15.5			13			dB
Output Power for 1 dB Compression (P1dB)	13	15.5		13	15.7		19	21.5		19	21.5		dBm
Saturated Output Power (Psat)	19			19			23.5			23.3			dBm
Output Third Order Intercept (IP3)	35			34.5			40.5			40			dBm
Supply Current (Idd)	187			200			187			200			mA

* R_{bias} resistor sets current, see application circuit herein



Broadband Gain & Return Loss [1] [2]

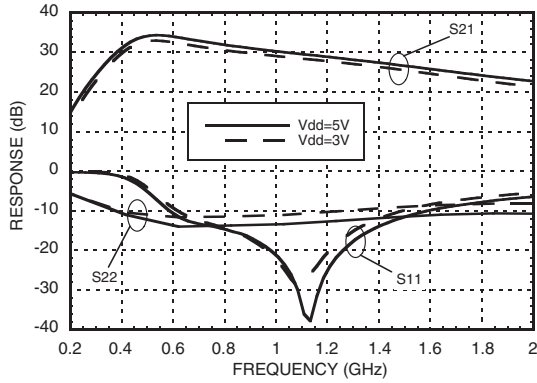

Gain vs. Temperature [1]

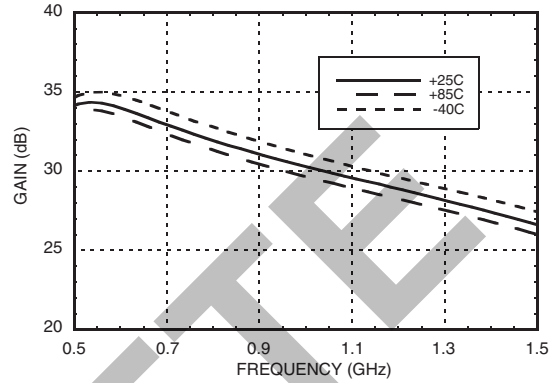

Gain vs. Temperature [2]

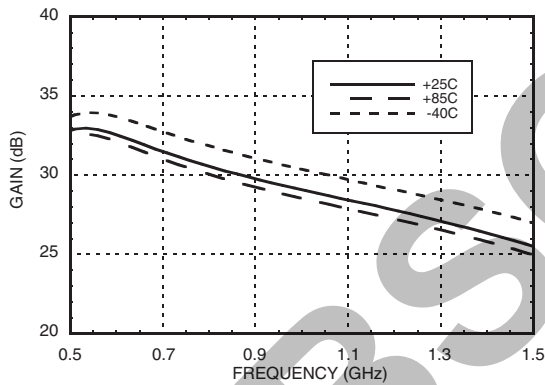

Input Return Loss vs. Temperature [1]

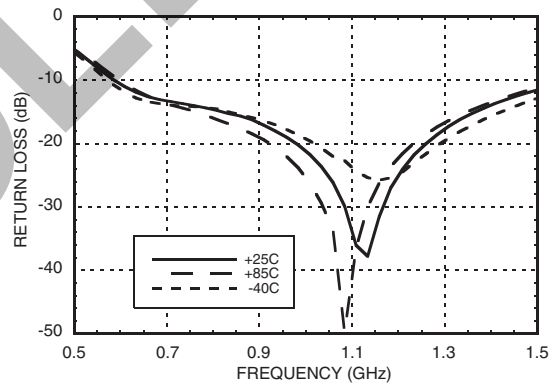

Output Return Loss vs. Temperature [1]

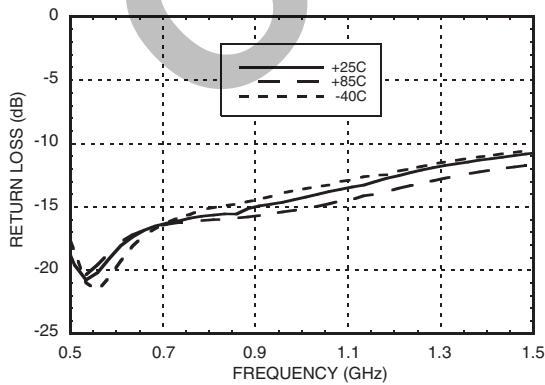

Reverse Isolation vs. Temperature [1]

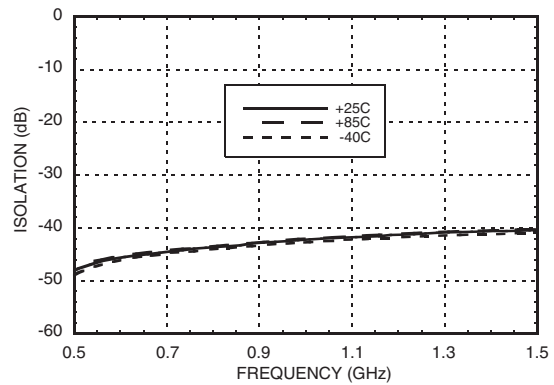

[1] Vdd = 5V, Rbias = 3.92K [2] Vdd = 3V, Rbias = 3.92K

Information furnished by Analog Devices is believed to be accurate and reliable. However, no responsibility is assumed by Analog Devices for its use, nor for any infringements of patents or other rights of third parties that may result from its use. Specifications subject to change without notice. No license is granted by implication or otherwise under any patent or patent rights of Analog Devices. Trademarks and registered trademarks are the property of their respective owners.

For price, delivery, and to place orders: Analog Devices, Inc., One Technology Way, P.O. Box 9106, Norwood, MA 02062-9106 Phone: 781-329-4700 • Order online at www.analog.com Application Support: Phone: 1-800-ANALOG-D



Noise Figure vs. Temperature [1] [2]

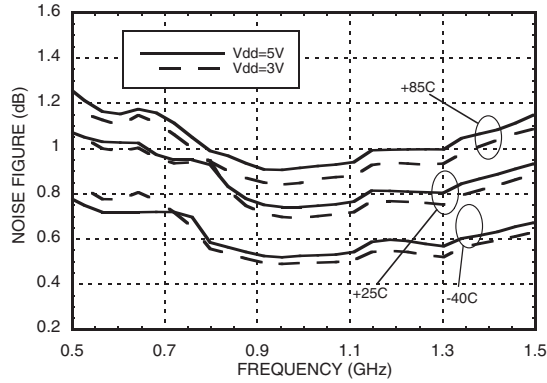

P1dB vs. Temperature [1] [2]

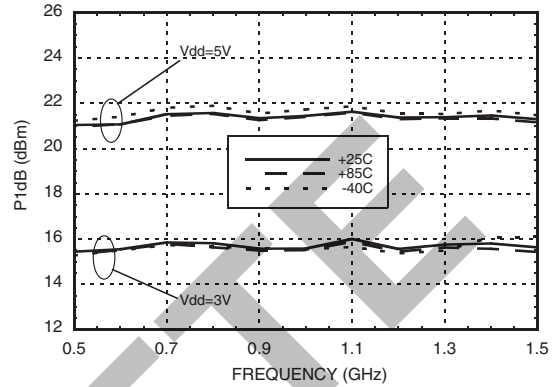

Psat vs. Temperature [1] [2]

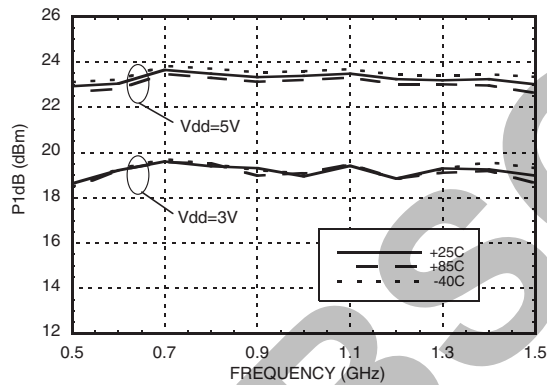

Output IP3 vs. Temperature [1] [2]

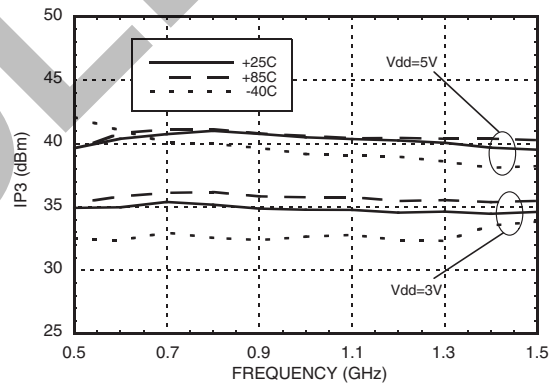

Output IP3 and Idd vs. Supply Voltage @ 700 MHz [3]

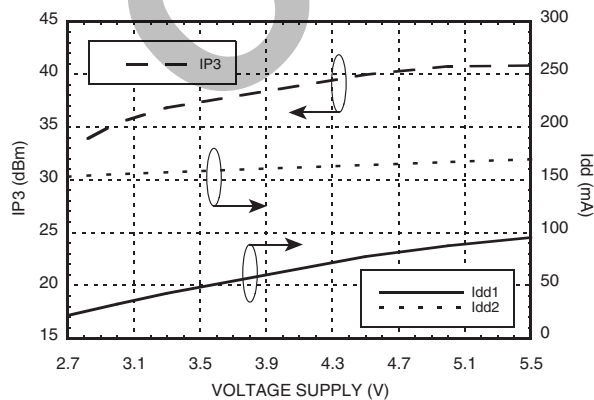

Output IP3 and Idd vs. Supply Voltage @ 1300 MHz [3]

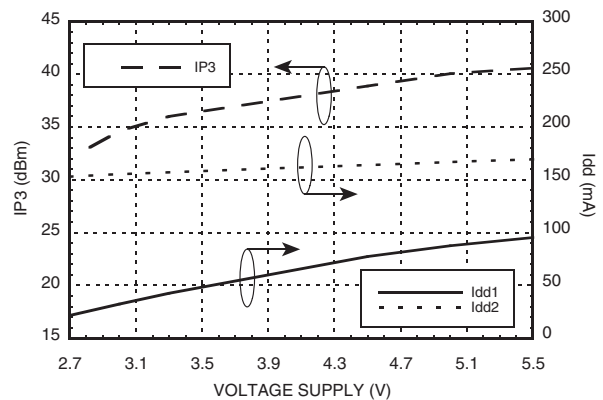

[1] V_{dd} = 5V, R_{bias} = 3.92K [2] V_{dd} = 3V, R_{bias} = 3.92K [3] R_{bias} = 3.92K

Information furnished by Analog Devices is believed to be accurate and reliable. However, no responsibility is assumed by Analog Devices for its use, nor for any infringements of patents or other rights of third parties that may result from its use. Specifications subject to change without notice. No license is granted by implication or otherwise under any patent or patent rights of Analog Devices. Trademarks and registered trademarks are the property of their respective owners.

For price, delivery, and to place orders: Analog Devices, Inc., One Technology Way, P.O. Box 9106, Norwood, MA 02062-9106 Phone: 781-329-4700 • Order online at www.analog.com Application Support: Phone: 1-800-ANALOG-D



Power Compression @ 700 MHz [1]

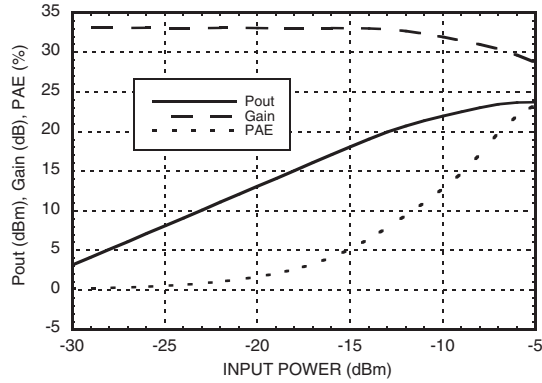

Power Compression @ 700 MHz [2]

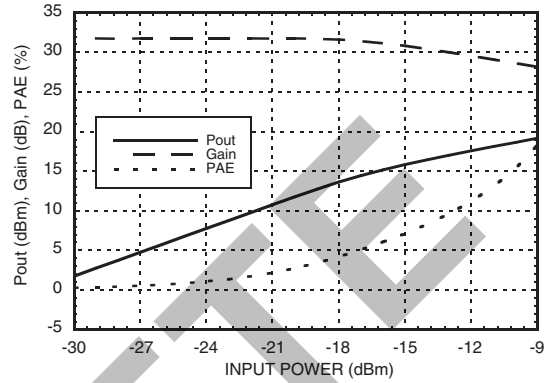

Power Compression @ 1300 MHz [1]

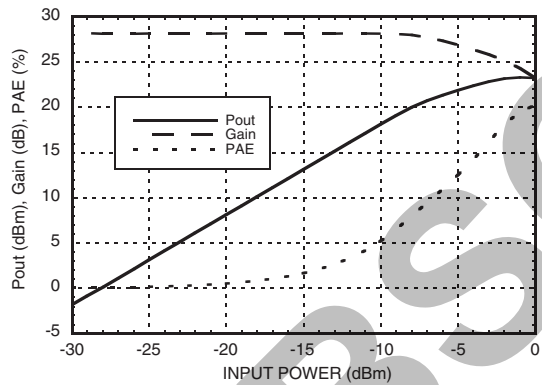

Power Compression @ 1300 MHz [2]

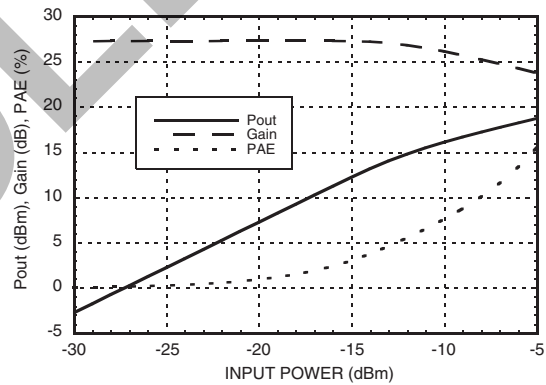

Gain, Power & Noise Figure vs. Supply Voltage @ 700 MHz [3]

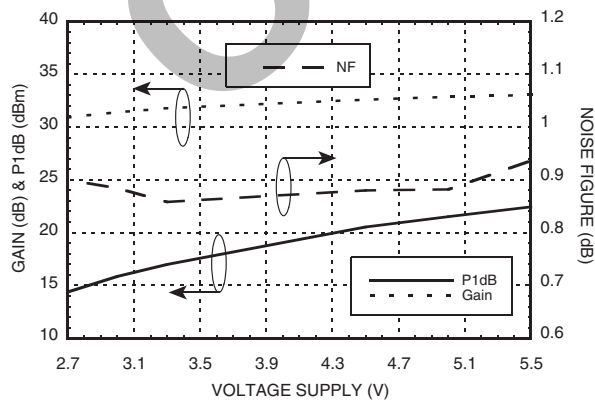

Gain, Power & Noise Figure vs. Supply Voltage @ 1300 MHz [3]

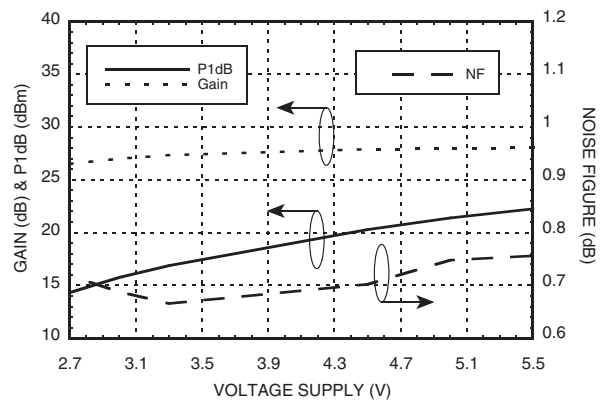

[1] Vdd = 5V, Rbias = 3.92K [2] Vdd = 3V, Rbias = 3.92K [3] Rbias = 3.92K

Information furnished by Analog Devices is believed to be accurate and reliable. However, no responsibility is assumed by Analog Devices for its use, nor for any infringements of patents or other rights of third parties that may result from its use. Specifications subject to change without notice. No license is granted by implication or otherwise under any patent or patent rights of Analog Devices. Trademarks and registered trademarks are the property of their respective owners.

For price, delivery, and to place orders: Analog Devices, Inc., One Technology Way, P.O. Box 9106, Norwood, MA 02062-9106 Phone: 781-329-4700 • Order online at www.analog.com Application Support: Phone: 1-800-ANALOG-D



HMC718LP4 / 718LP4E

**GaAs PHEMT MMIC HIGH IP3
LOW NOISE AMPLIFIER, 0.6 - 1.4 GHz**

7

AMPLIFIERS - LOW NOISE - SMT

Output IP3 vs. Rbias @ 900 MHz

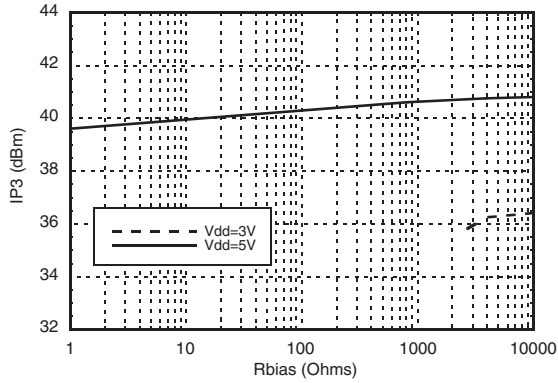

Gain, Noise Figure & Rbias @ 900 MHz

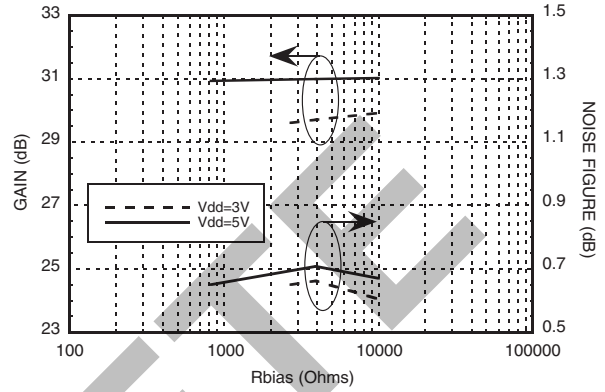

OBSOLETE



Absolute Bias Resistor Range & Recommended Bias Resistor Values for I_{dd}

V _{dd} (V)	R _{bias} Ω			I _{dd1} (mA)	I _{dd2} (mA)
	Min	Max	Recommended		
3V	1K [1]	Open Circuit	2.7k	27	155
			3.9k	32	155
			10k	41	155
5V	0	Open Circuit	820	67	166
			3.92k	88	166
			10k	92	166

[1] Operation with V_{dd}= 3V and R_{bias} < 1K Ohm may result in the part becoming conditionally stable which is not recommended.

Absolute Maximum Ratings

Drain Bias Voltage (V _{dd})	5.5 V
RF Input Power (RFIN) (V _{dd} = +5 V _{dc})	-5 dBm
Channel Temperature	175 °C
Continuous P _{diss} (T= 85 °C) (derate 20 mW/°C above 85 °C)	1.8 W
Thermal Resistance (channel to ground paddle)	50 °C/W
Storage Temperature	-65 to +150 °C
Operating Temperature	-40 to +85 °C

Typical Supply Current vs. V_{dd} (R_{bias} = 3.92k)

V _{dd} (V)	I _{dd1} (mA)	I _{dd2} (mA)
2.7	22	153
3.0	32	155
3.3	43	157
4.5	77	164
5.0	88	166
5.5	95	169

Note: Amplifier will operate over full voltage ranges shown above.



**ELECTROSTATIC SENSITIVE DEVICE
OBSERVE HANDLING PRECAUTIONS**



Outline Drawing

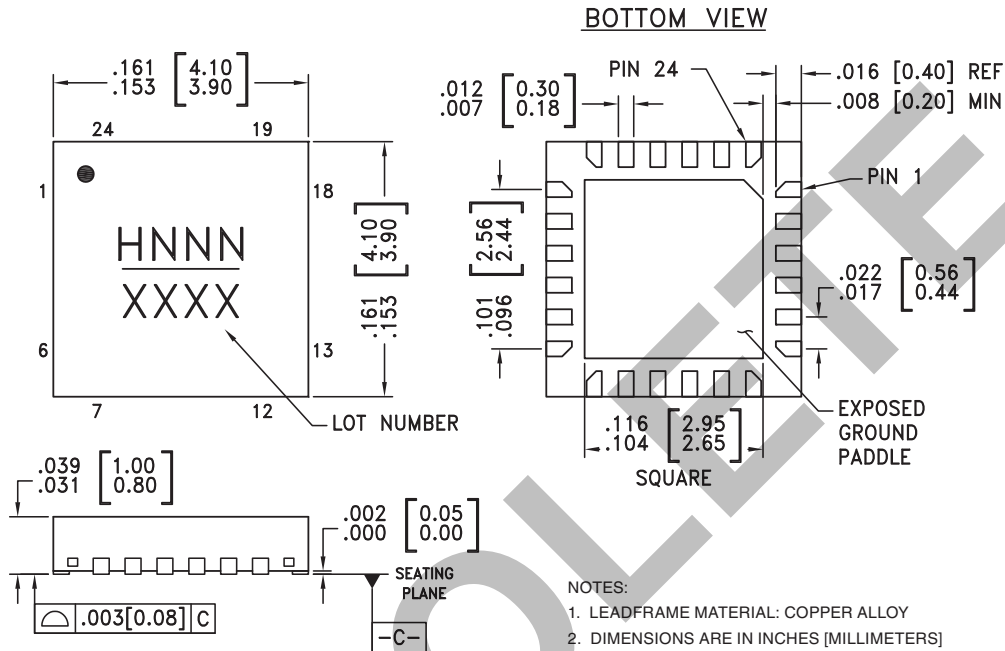

Package Information

Part Number	Package Body Material	Lead Finish	MSL Rating	Package Marking ^[3]
HMC718LP4	Low Stress Injection Molded Plastic	Sn/Pb Solder	MSL1 ^[1]	H718 XXXX
HMC718LP4E	RoHS-compliant Low Stress Injection Molded Plastic	100% matte Sn	MSL1 ^[2]	H718 XXXX

[1] Max peak reflow temperature of 235 °C
 [2] Max peak reflow temperature of 260 °C
 [3] 4-Digit lot number XXXX

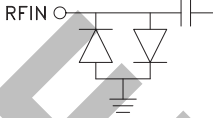
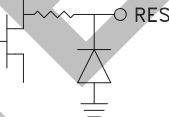
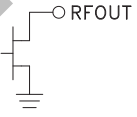
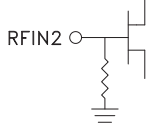
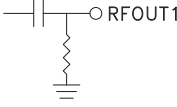
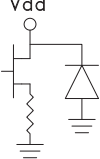

Pin Descriptions

Pin Number	Function	Description	Interface Schematic
1, 3 - 5, 7 - 16, 18, 20, 22, 23	N/C	No connection necessary. These pins may be connected to RF/DC ground without affecting performance.	
2	RFIN	This pin is DC coupled and matched to 50 Ohms.	
6	RES	This pin is used to set the DC current of the amplifier by selection of external bias resistor. See application circuit.	
17	RFOUT	RF Output and DC BIAS for the second amplifier. See Application Circuit for off-chip components.	
19	RFIN2	This pin is DC coupled. An off-chip DC blocking capacitor is required.	
21	RFOUT1	This pin is matched to 50 Ohms.	
24	Vdd	Power Supply Voltage for the first amplifier. Choke inductor and bypass capacitors are required. See application circuit.	



Application Circuit

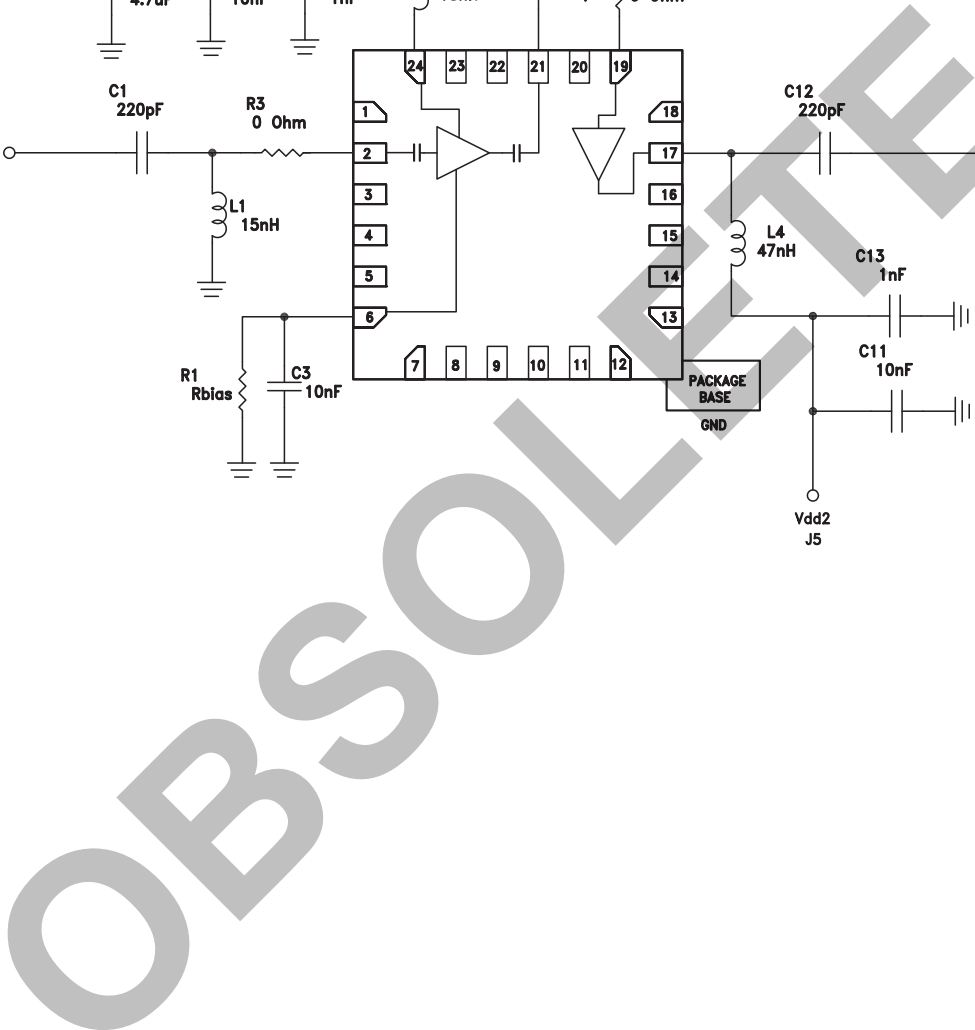
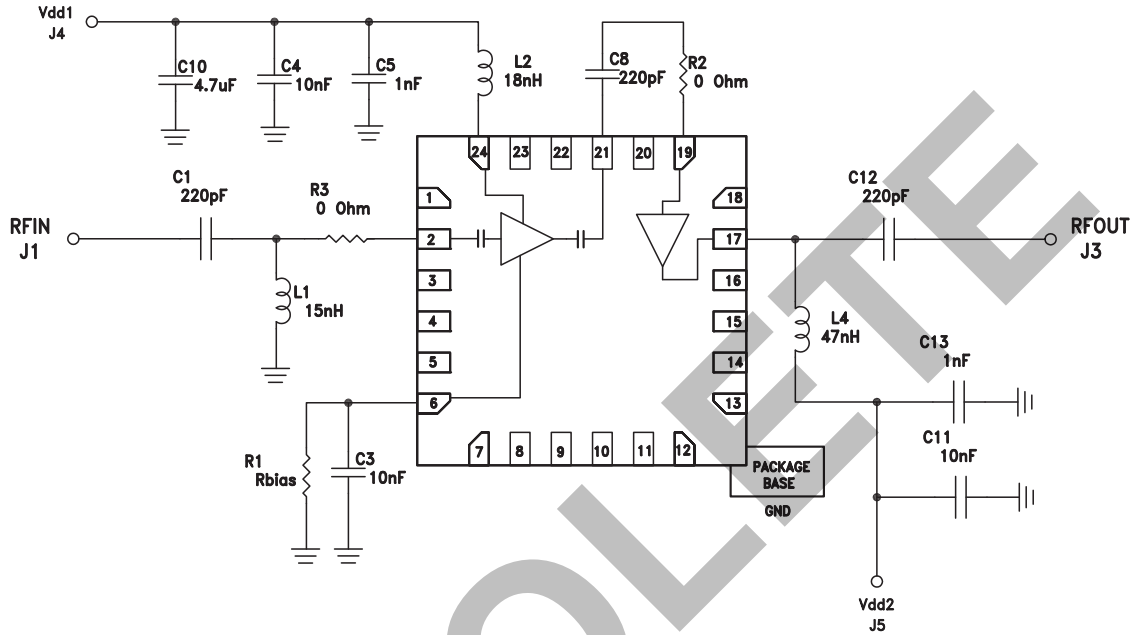



Evaluation PCB

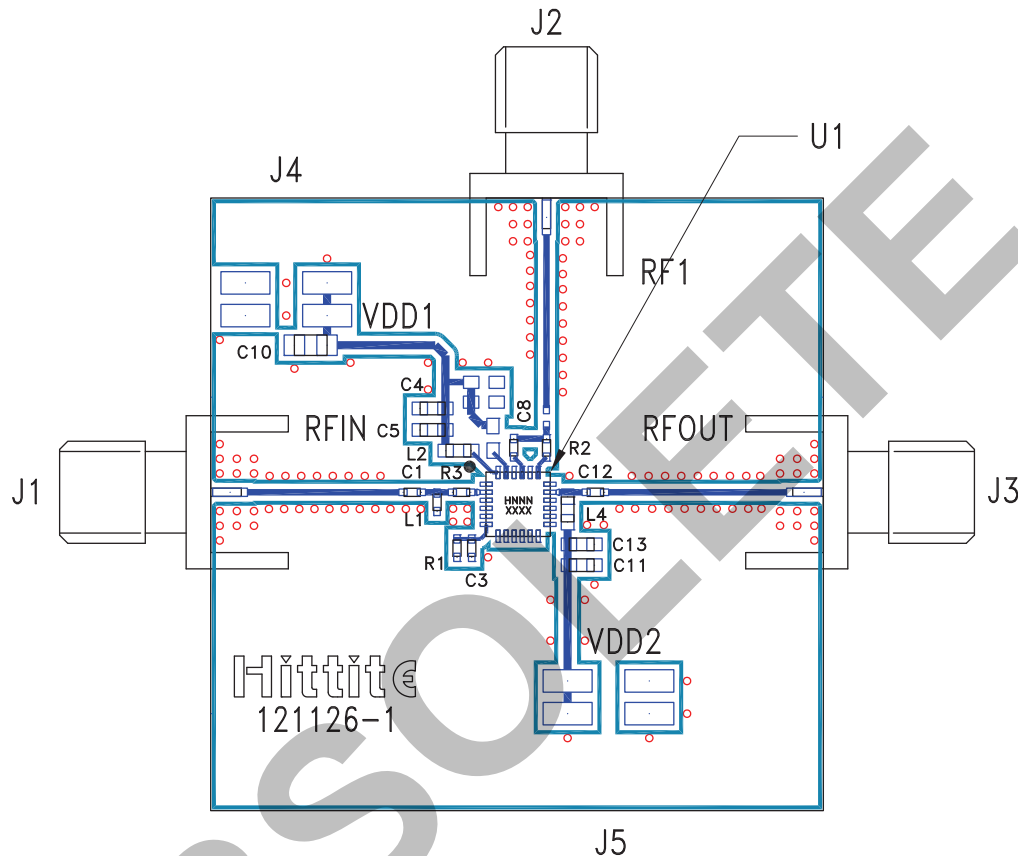

List of Materials for Evaluation PCB 121128 [1]

Item	Description
J1 - J3	PCB Mount SMA Connector
J4 - J5	2mm Vertical Molex Connector
C1, C8, C12	220 pF Capacitor, 0402 Pkg.
C3	10 nF Capacitor, 0402 Pkg.
C4, C11	10 nF Capacitor, 0603 Pkg.
C5, C13	1000 pF Capacitor, 0603 Pkg.
C10	4.7 uF Capacitor, 0805 Pkg.
L1	15 nH Inductor, 0402 Pkg.
L2	18 nH Inductor, 0603 Pkg.
L4	47 nH Inductor, 0603 Pkg.
R1	Rbias Resistor, 0402 Pkg.
R2, R3	0 Ohm Resistor, 0402 Pkg.
U1	HMC718LP4(E) Amplifier
PCB [2]	121126 Evaluation PCB

[1] Reference this number when ordering complete evaluation PCB

[2] Circuit Board Material: Arlon 25FR

The circuit board used in this application should use RF circuit design techniques. Signal lines should have 50 Ohm impedance while the package ground leads and exposed paddle should be connected directly to the ground plane similar to that shown. A sufficient number of via holes should be used to connect the top and bottom ground planes. The evaluation board should be mounted to an appropriate heat sink. The evaluation circuit board shown is available from Hittite upon request.