



Chipsmall Limited consists of a professional team with an average of over 10 year of expertise in the distribution of electronic components. Based in Hongkong, we have already established firm and mutual-benefit business relationships with customers from,Europe,America and south Asia,supplying obsolete and hard-to-find components to meet their specific needs.

With the principle of “Quality Parts,Customers Priority,Honest Operation,and Considerate Service”,our business mainly focus on the distribution of electronic components. Line cards we deal with include Microchip,ALPS,ROHM,Xilinx,Pulse,ON,Everlight and Freescale. Main products comprise IC,Modules,Potentiometer,IC Socket,Relay,Connector.Our parts cover such applications as commercial,industrial, and automotives areas.

We are looking forward to setting up business relationship with you and hope to provide you with the best service and solution. Let us make a better world for our industry!



Contact us

Tel: +86-755-8981 8866 Fax: +86-755-8427 6832

Email & Skype: info@chipsmall.com Web: www.chipsmall.com

Address: A1208, Overseas Decoration Building, #122 Zhenhua RD., Futian, Shenzhen, China





GaAs PHEMT MMIC HIGH IP3 LOW NOISE AMPLIFIER, 1.3 - 2.9 GHz

Typical Applications

The HMC719LP4(E) is ideal for:

- Cellular/3G and LTE/WiMAX/4G
- BTS & Infrastructure
- Repeaters and Femtocells
- Access Points
- Test Equipment & Military

Features

- Noise Figure: 1.0 dB
- Gain: 34 dB
- Output IP3: +39 dBm
- Single Supply: +3V to +5V
- 50 Ohm Matched Input/Output
- 24 Lead 4x4 mm SMT Package: 16 mm²

Functional Diagram

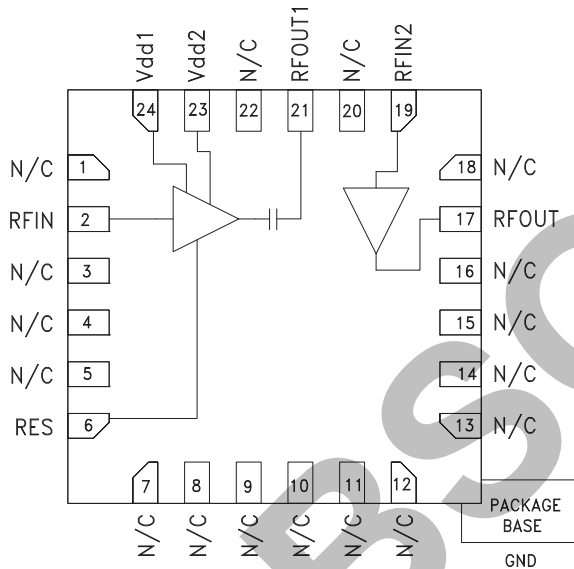

General Description

The HMC719LP4(E) is a GaAs PHEMT MMIC Low Noise Amplifier that is ideal for Cellular/3G and LTE/WiMAX/4G basestation front-end receivers operating between 1.3 and 2.9 GHz. The amplifier has been optimized to provide 1.0 dB noise figure, 34 dB gain and +39 dBm output IP3 from a single supply of +5V. Input and output return losses are excellent and the LNA requires minimal external matching and bias decoupling components. The HMC719LP4(E) shares the same package and pinout with the HMC718LP3(E) 600 - 1400 MHz LNA. The HMC719LP4(E) can be biased with +3V to +5V and features an externally adjustable supply current which allows the designer to tailor the linearity performance of the LNA for each application.

Electrical Specifications, $T_A = +25^\circ\text{C}$, $R_{bias} = 1.5k\ \text{Ohms}^*$

| Parameter | Vdd = +3V | | | Vdd = +5V | | | Vdd = +3V | | | Vdd = +5V | | | Units |
|--|-----------|------|------|-----------|------|------|-----------|------|------|-----------|------|------|-------|
| | Min. | Typ. | Max. | Min. | Typ. | Max. | Min. | Typ. | Max. | Min. | Typ. | Max. | |
| Frequency Range | 1.3 - 2.2 | | | 2.2 - 2.9 | | | 1.3 - 2.2 | | | 2.2 - 2.9 | | | GHz |
| Gain | 27 | 32 | | 22 | 26.5 | | 29 | 35 | | 24 | 28 | | dB |
| Gain Variation Over Temperature | | 0.02 | | | 0.02 | | | 0.02 | | | 0.02 | | dB/°C |
| Noise Figure | | 1.0 | 1.3 | | 1.3 | 1.6 | | 0.95 | 1.2 | | 1.25 | 1.6 | dB |
| Input Return Loss | | 16 | | | 13.5 | | | 17.5 | | | 16.5 | | dB |
| Output Return Loss | | 10.5 | | | 9.5 | | | 13.5 | | | 11.5 | | dB |
| Output Power for 1 dB Compression (P1dB) | 12.5 | 15.5 | | 12.5 | 15.5 | | 18 | 21.5 | | 18 | 21.5 | | dBm |
| Saturated Output Power (Psat) | | 18 | | | 18.5 | | | 23 | | | 23 | | dBm |
| Output Third Order Intercept (IP3) | | 32 | | | 31 | | | 39 | | | 39 | | dBm |
| Total Supply Current (Idd) | | 187 | 220 | | 187 | 220 | | 272 | 315 | | 272 | 315 | mA |

* Rbias resistor sets current, see application circuit herein, Vdd = Vdd1 = Vdd2



Broadband Gain & Return Loss [1] [2]

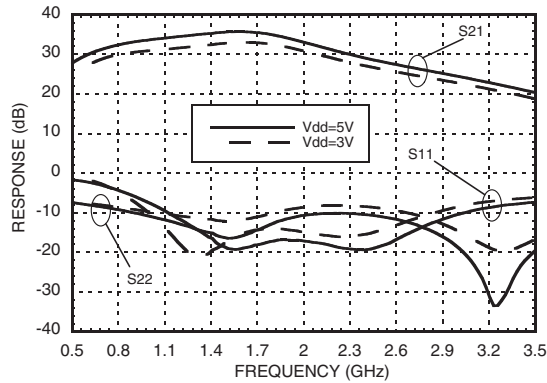

Gain vs. Temperature [1]

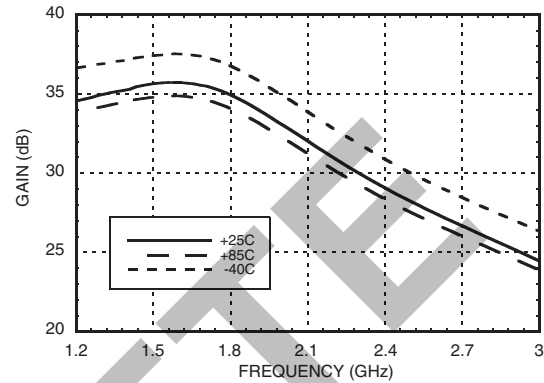

Gain vs. Temperature [2]

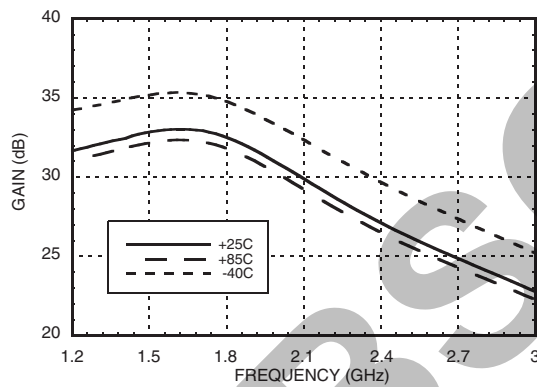

Input Return Loss vs. Temperature [1]

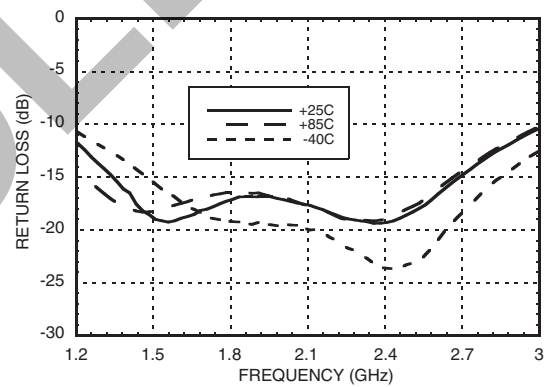

Output Return Loss vs. Temperature [1]

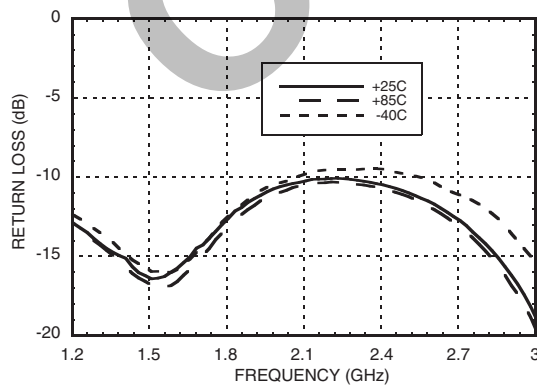

Reverse Isolation vs. Temperature [1]

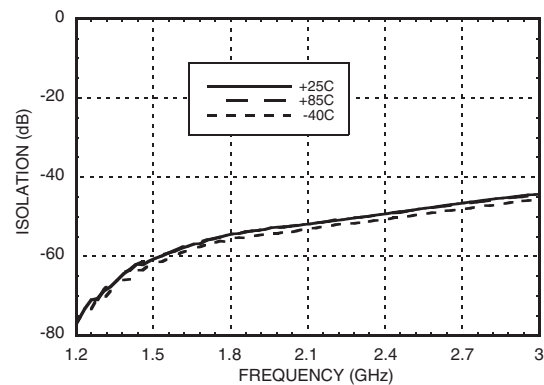

[1] Vdd = 5V, Rbias = 1.5K [2] Vdd = 3V, Rbias = 1.5K

Information furnished by Analog Devices is believed to be accurate and reliable. However, no responsibility is assumed by Analog Devices for its use, nor for any infringements of patents or other rights of third parties that may result from its use. Specifications subject to change without notice. No license is granted by implication or otherwise under any patent or patent rights of Analog Devices. Trademarks and registered trademarks are the property of their respective owners.

For price, delivery, and to place orders: Analog Devices, Inc., One Technology Way, P.O. Box 9106, Norwood, MA 02062-9106 Phone: 781-329-4700 • Order online at www.analog.com Application Support: Phone: 1-800-ANALOG-D



Noise Figure vs. Temperature [1] [2]

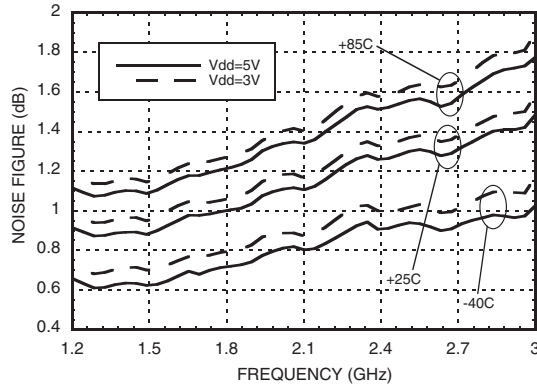

P1dB vs. Temperature [1] [2]

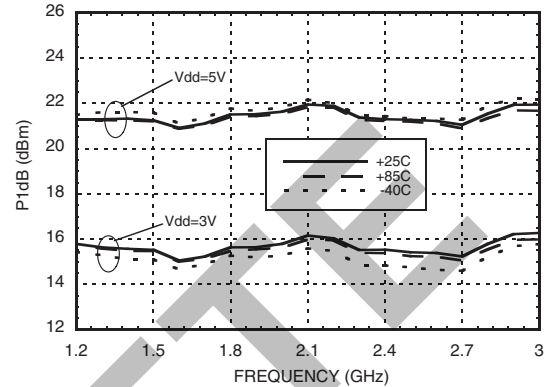

Psat vs. Temperature [1] [2]

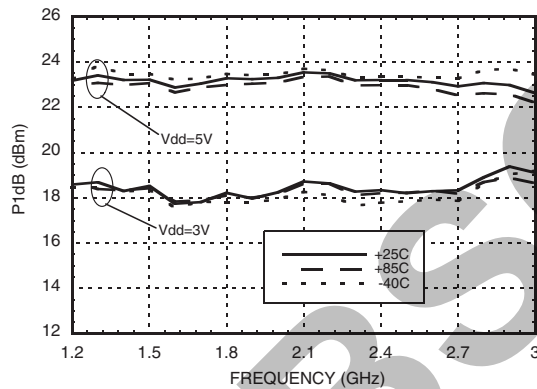

Output IP3 vs. Temperature [1] [2]

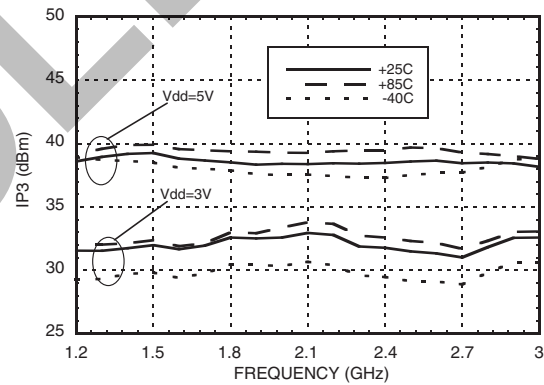

Output IP3 and Idd vs. Supply Voltage @ 1700 MHz [3]

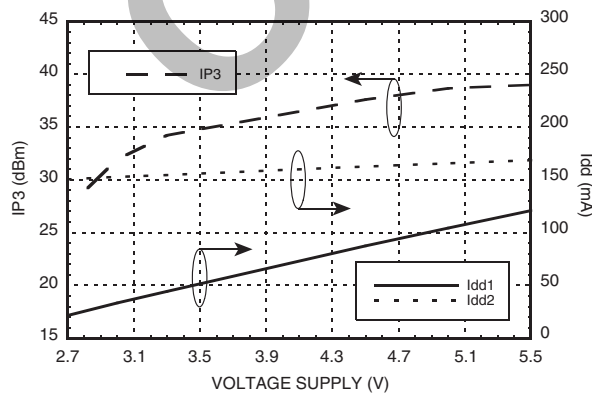

Output IP3 and Idd vs. Supply Voltage @ 2200 MHz [3]

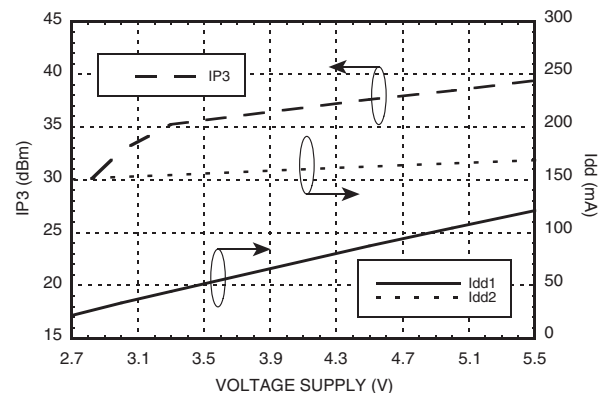

[1] Vdd = 5V, Rbias = 1.5K [2] Vdd = 3V, Rbias = 1.5K [3] Rbias = 1.5K

Information furnished by Analog Devices is believed to be accurate and reliable. However, no responsibility is assumed by Analog Devices for its use, nor for any infringements of patents or other rights of third parties that may result from its use. Specifications subject to change without notice. No license is granted by implication or otherwise under any patent or patent rights of Analog Devices. Trademarks and registered trademarks are the property of their respective owners.

For price, delivery, and to place orders, contact Analog Devices, Inc., One Technology Way, P.O. Box 9106, Norwood, MA 02062-9106 Phone: 781-329-4700 • Order online at www.analog.com Application Support: Phone: 1-800-ANALOG-D



Power Compression @ 1700 MHz [1]

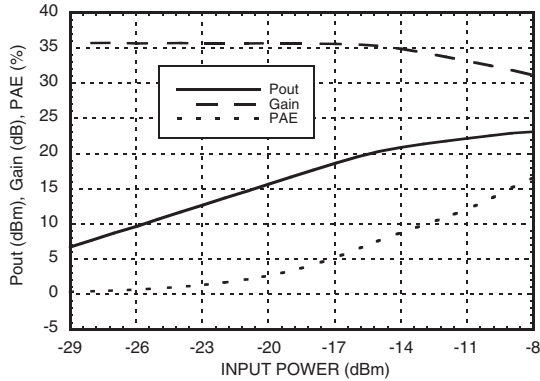

Power Compression @ 1700 MHz [2]

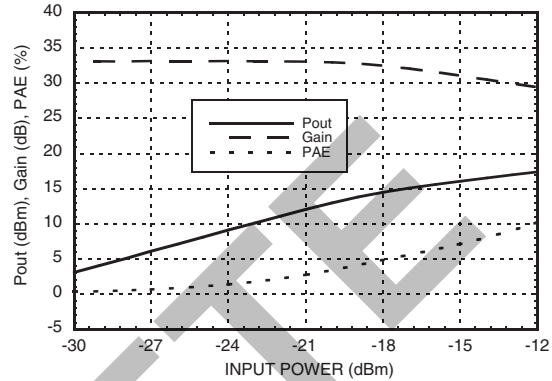

Power Compression @ 2200 MHz [1]

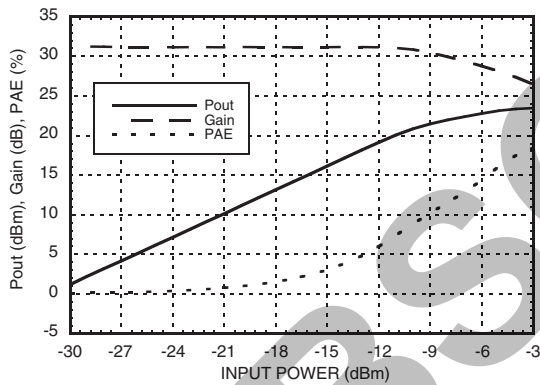

Power Compression @ 2200 MHz [2]

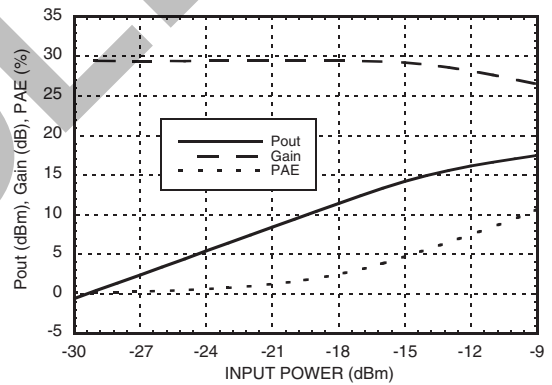

Gain, Power & Noise Figure vs. Supply Voltage @ 1700 MHz [3]

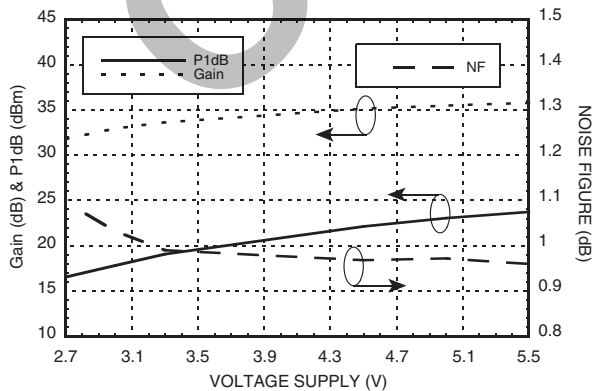

Gain, Power & Noise Figure vs. Supply Voltage @ 2200 MHz [3]

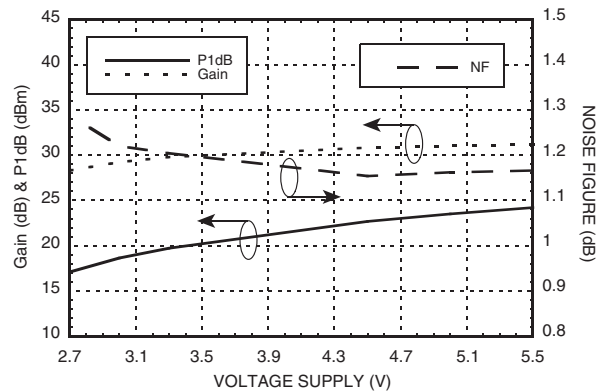

[1] Vdd = 5V, Rbias = 1.5K [2] Vdd = 3V, Rbias = 1.5K [3] Rbias = 1.5K

Information furnished by Analog Devices is believed to be accurate and reliable. However, no responsibility is assumed by Analog Devices for its use, nor for any infringements of patents or other rights of third parties that may result from its use. Specifications subject to change without notice. No license is granted by implication or otherwise under any patent or patent rights of Analog Devices. Trademarks and registered trademarks are the property of their respective owners.

For price, delivery, and to place orders: Analog Devices, Inc., One Technology Way, P.O. Box 9106, Norwood, MA 02062-9106 Phone: 781-329-4700 • Order online at www.analog.com Application Support: Phone: 1-800-ANALOG-D



HMC719LP4 / 719LP4E

**GaAs PHEMT MMIC HIGH IP3
LOW NOISE AMPLIFIER, 1.3 - 2.9 GHz**

7

AMPLIFIERS - LOW NOISE - SMT

Output IP3 vs. Rbias @ 1900 MHz

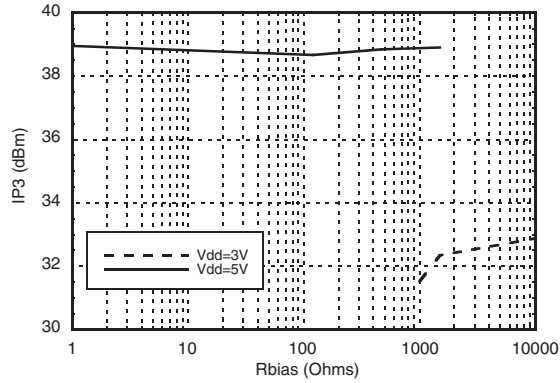

Gain, Noise Figure & Rbias @ 1900 MHz

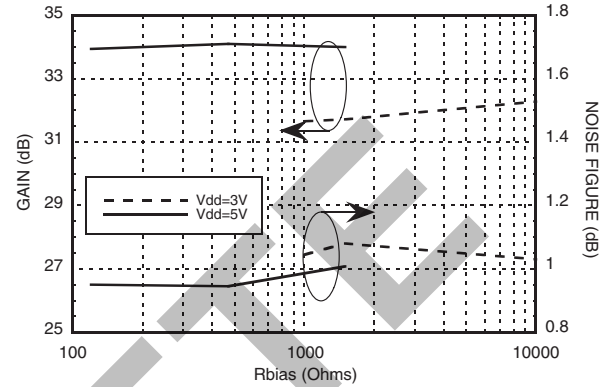

OBSOLETE



Absolute Bias Resistor

Range & Recommended Bias Resistor Values for Idd

| Vdd (V) | Rbias Ω | | | Idd1 (mA) | Idd2 (mA) |
|---------|---------|--------------|-------------|-----------|-----------|
| | Min | Max | Recommended | | |
| 3V | 1K [1] | Open Circuit | 1k | 27 | 154 |
| | | | 1.5k | 33 | 154 |
| | | | 10k | 46 | 154 |
| 5V | 0 | Open Circuit | 120 | 70 | 168 |
| | | | 470 | 88 | 168 |
| | | | 1.5k | 104 | 168 |

[1] Operation with Vdd= 3V and Rbias < 1K Ohm may result in the part becoming conditionally stable which is not recommended.

Absolute Maximum Ratings

| | |
|--|----------------|
| Drain Bias Voltage (Vdd) | 5.5 V |
| RF Input Power (RFIN) (Vdd = +5 Vdc) | -5 dBm |
| Channel Temperature | 175 °C |
| Continuous P _{diss} (T= 85 °C) (derate 21.2 mW/°C above 85 °C) | 1.9 W |
| Thermal Resistance (channel to ground paddle) | 47.3 °C/W |
| Storage Temperature | -65 to +150 °C |
| Operating Temperature | -40 to +85 °C |

Typical Supply Current vs. Vdd (Rbias = 1.5k)

| Vdd (V) | Idd1 (mA) | Idd2 (mA) |
|---------|-----------|-----------|
| 2.7 | 22 | 150 |
| 3.0 | 33 | 154 |
| 3.3 | 44 | 155 |
| 4.5 | 87 | 163 |
| 5.0 | 104 | 168 |
| 5.5 | 121 | 169 |

Note: Amplifier will operate over full voltage ranges shown above.



**ELECTROSTATIC SENSITIVE DEVICE
OBSERVE HANDLING PRECAUTIONS**



Outline Drawing

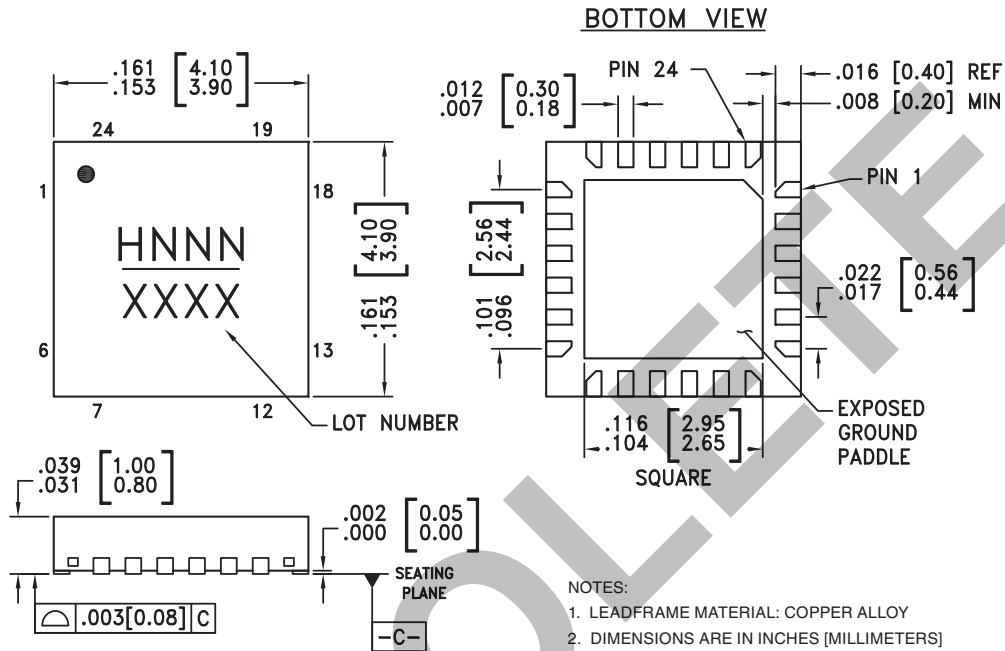

NOTES:

1. LEADFRAME MATERIAL: COPPER ALLOY
2. DIMENSIONS ARE IN INCHES [MILLIMETERS]
3. LEAD SPACING TOLERANCE IS NON-CUMULATIVE
4. PAD BURR LENGTH SHALL BE 0.15mm MAXIMUM. PAD BURR HEIGHT SHALL BE 0.05mm MAXIMUM.
5. PACKAGE WARP SHALL NOT EXCEED 0.05mm.
6. ALL GROUND LEADS AND GROUND PADDLE MUST BE SOLDERED TO PCB RF GROUND.
7. REFER TO HITTITE APPLICATION NOTE FOR SUGGESTED LAND PATTERN.

Package Information

| Part Number | Package Body Material | Lead Finish | MSL Rating | Package Marking ^[3] |
|-------------|--|---------------|---------------------|--------------------------------|
| HMC719LP4 | Low Stress Injection Molded Plastic | Sn/Pb Solder | MSL1 ^[1] | H719 XXXX |
| HMC719LP4E | RoHS-compliant Low Stress Injection Molded Plastic | 100% matte Sn | MSL1 ^[2] | H719 XXXX |

[1] Max peak reflow temperature of 235 °C

[2] Max peak reflow temperature of 260 °C

[3] 4-Digit lot number XXXX

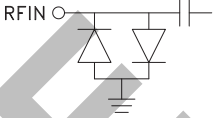
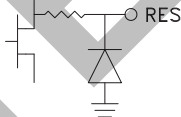
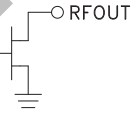
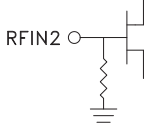
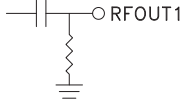
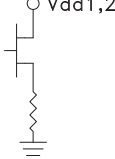

Pin Descriptions

| Pin Number | Function | Description | Interface Schematic |
|------------------------------|----------|--|---|
| 1, 3 - 5, 7 - 16, 18, 20, 22 | N/C | No connection necessary. These pins may be connected to RF/DC ground without affecting performance. | |
| 2 | RFIN | This pin is DC coupled and matched to 50 Ohms. |  |
| 6 | RES | This pin is used to set the DC current of the amplifier by selection of external bias resistor. See application circuit. |  |
| 17 | RFOUT | RF Output and DC BIAS for the second amplifier. See Application Circuit for off-chip components. |  |
| 19 | RFIN2 | This pin is DC coupled. An off-chip DC blocking capacitor is required. |  |
| 21 | RFOUT1 | This pin is matched to 50 Ohms. |  |
| 23, 24 | Vdd1, 2 | Power Supply Voltage for the first amplifier. External bypass capacitors are required. See application circuit. |  |



**GaAs PHEMT MMIC HIGH IP3
LOW NOISE AMPLIFIER, 1.3 - 2.9 GHz**

7

Application Circuit

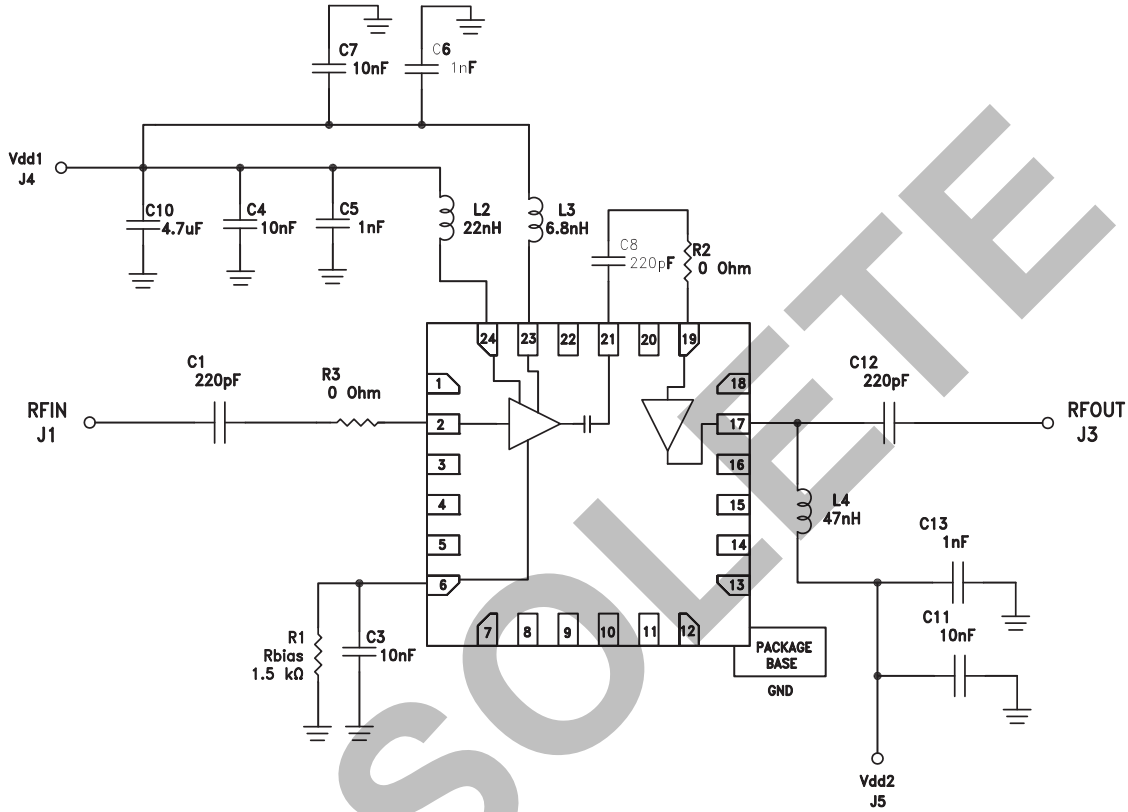

AMPLIFIERS - LOW NOISE - SMT



Evaluation PCB

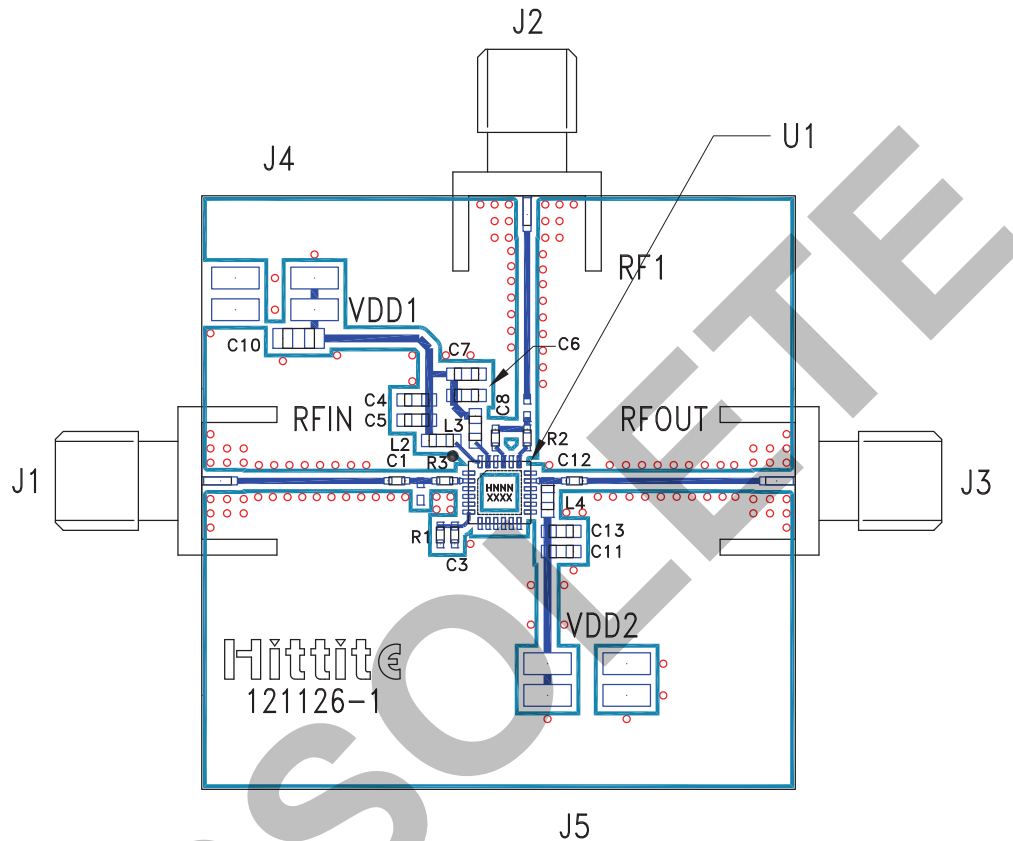

List of Materials for Evaluation PCB 121242 [1]

| Item | Description |
|-------------|------------------------------------|
| J1 - J3 | PCB Mount SMA Connector |
| J4 - J5 | 2mm Vertical Molex Connector |
| C1, C8, C12 | 220 pF Capacitor, 0402 Pkg. |
| C3 | 10 nF Capacitor, 0402 Pkg. |
| C4, C7, C11 | 10 nF Capacitor, 0603 Pkg. |
| C5, C6, C13 | 1000 pF Capacitor, 0603 Pkg. |
| C10 | 4.7 uF Capacitor, 0805 Pkg. |
| L2 | 22 nH Inductor, 0402 Pkg. |
| L3 | 6.8 nH Inductor, 0603 Pkg. |
| L4 | 47 nH Inductor, 0603 Pkg. |
| R1 | 1.5 kOhm Rbias Resistor, 0402 Pkg. |
| R2, R3 | 0 Ohm Resistor, 0402 Pkg. |
| U1 | HMC719LP4(E) Amplifier |
| PCB [2] | 121126 Evaluation PCB |

[1] Reference this number when ordering complete evaluation PCB

[2] Circuit Board Material: Arlon 25RF

The circuit board used in this application should use RF circuit design techniques. Signal lines should have 50 Ohm impedance while the package ground leads and exposed paddle should be connected directly to the ground plane similar to that shown. A sufficient number of via holes should be used to connect the top and bottom ground planes. The evaluation board should be mounted to an appropriate heat sink. The evaluation circuit board shown is available from Hittite upon request.