



Chipsmall Limited consists of a professional team with an average of over 10 year of expertise in the distribution of electronic components. Based in Hongkong, we have already established firm and mutual-benefit business relationships with customers from,Europe,America and south Asia,supplying obsolete and hard-to-find components to meet their specific needs.

With the principle of “Quality Parts,Customers Priority,Honest Operation,and Considerate Service”,our business mainly focus on the distribution of electronic components. Line cards we deal with include Microchip,ALPS,ROHM,Xilinx,Pulse,ON,Everlight and Freescale. Main products comprise IC,Modules,Potentiometer,IC Socket,Relay,Connector.Our parts cover such applications as commercial,industrial, and automotives areas.

We are looking forward to setting up business relationship with you and hope to provide you with the best service and solution. Let us make a better world for our industry!



Contact us

Tel: +86-755-8981 8866 Fax: +86-755-8427 6832

Email & Skype: info@chipsmall.com Web: www.chipsmall.com

Address: A1208, Overseas Decoration Building, #122 Zhenhua RD., Futian, Shenzhen, China





GaAs HEMT MMIC LOW NOISE AMPLIFIER, 24 - 28 GHz

Typical Applications

This HMC752LC4 is ideal for:

- Point-to-Point Radios
- Point-to-Multi-Point Radios
- Military & Space
- Test Instrumentation

Features

- Noise Figure: 2.5 dB
- Gain: 25 dB
- P1dB Output Power: +13 dBm
- Supply Voltage: +3V @ 70 mA
- Output IP3: +26 dBm
- 50 Ohm matched Input/Output
- 24 Lead Ceramic 4x4mm SMT Package: 16mm²

Functional Diagram

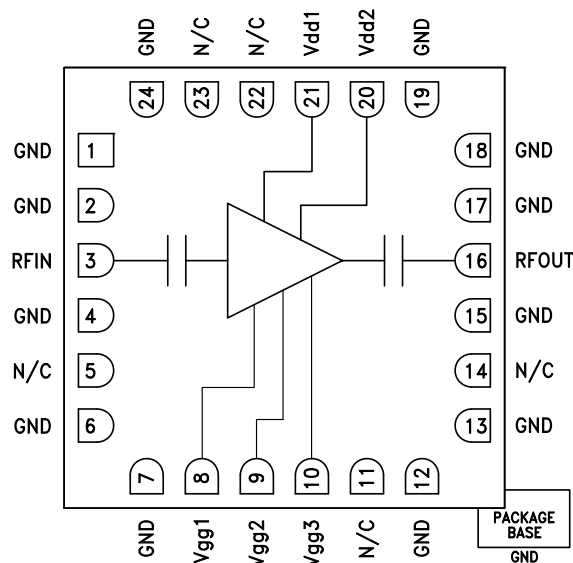

General Description

The HMC752LC4 is a GaAs MMIC Low Noise Wide-band Amplifier housed in a leadless 4x4 mm ceramic surface mount package. The amplifier operates between 24 and 28 GHz, providing up to 25 dB of small signal gain, 2.5 dB noise figure, and output IP3 of +26 dBm, while requiring only 70 mA from a +3V supply. The P1dB output power of up to +13 dBm enables the LNA to function as a LO driver for balanced, I/Q or image reject mixers. The HMC752LC4 also features I/Os that are DC blocked and internally matched to 50 Ohms, making it ideal for high capacity microwave radios or VSAT applications.

Electrical Specifications, $T_A = +25^\circ C$, $V_{dd} = V_{dd1} = V_{dd2} = +3V$, $I_{dd} = I_{dd1} + I_{dd2} = 70 mA$ ^[2]

Parameter	Min.	Typ.	Max.	Units
Frequency Range		24 - 28		GHz
Gain ^[1]	23	25		dB
Gain Variation over Temperature		0.02		dB / °C
Noise Figure ^[1]		2.5	3	dB
Input Return Loss		14		dB
Output Return Loss		14		dB
Output Power for 1 dB Compression ^[1]		13		dBm
Saturated Output Power (P _{sat}) ^[1]		16		dBm
Output Third Order Intercept (IP3)		26		dBm
Supply Current (I _{dd}) (V _{dd} = 3V, V _{gg} = V _{gg1} = V _{gg2} = V _{gg3} = -0.3V Typ.)		70		mA

[1] Board loss subtracted out for gain, power and noise figure measurement

[2] Adjust V_{gg} = between -1 to 0.3V to achieve I_{dd} = 70mA

HMC752* PRODUCT PAGE QUICK LINKS

Last Content Update: 02/23/2017

COMPARABLE PARTS

View a parametric search of comparable parts.

EVALUATION KITS

- HMC752LC4 Evaluation Board

DOCUMENTATION

Application Notes

- AN-1363: Meeting Biasing Requirements of Externally Biased RF/Microwave Amplifiers with Active Bias Controllers
- Broadband Biasing of Amplifiers General Application Note
- MMIC Amplifier Biasing Procedure Application Note
- Thermal Management for Surface Mount Components General Application Note

Data Sheet

- HMC752 Data Sheet

TOOLS AND SIMULATIONS

- HMC752 S-Parameter

REFERENCE MATERIALS

Quality Documentation

- Package/Assembly Qualification Test Report: LC4, LC4B (QTR: 2014-00380 REV: 01)
- Semiconductor Qualification Test Report: PHEMT-F (QTR: 2013-00269)

DESIGN RESOURCES

- HMC752 Material Declaration
- PCN-PDN Information
- Quality And Reliability
- Symbols and Footprints

DISCUSSIONS

View all HMC752 EngineerZone Discussions.

SAMPLE AND BUY

Visit the product page to see pricing options.

TECHNICAL SUPPORT

Submit a technical question or find your regional support number.

DOCUMENT FEEDBACK

Submit feedback for this data sheet.



**GaAs HEMT MMIC LOW NOISE
AMPLIFIER, 24 - 28 GHz**

Gain vs. Temperature

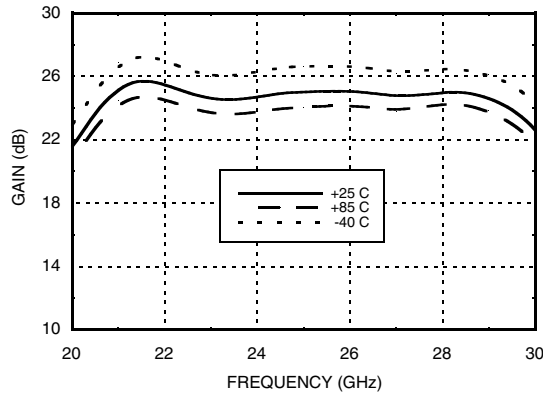

Gain vs. I_{dd}

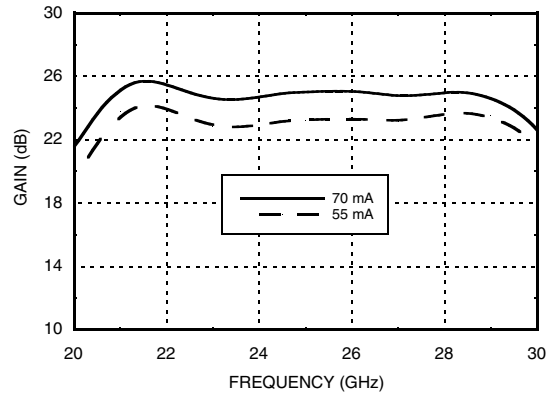

Input Return Loss vs. Temperature

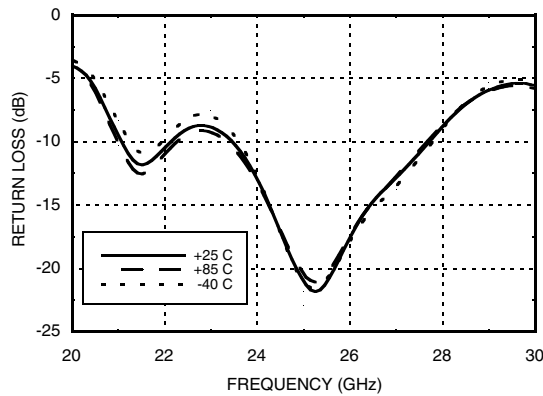

Output Return Loss vs. Temperature

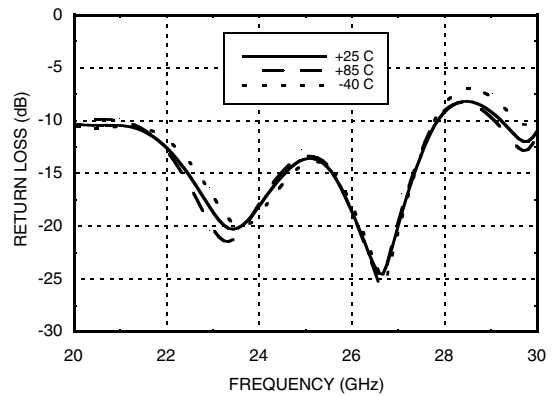

Noise Figure vs. Temperature

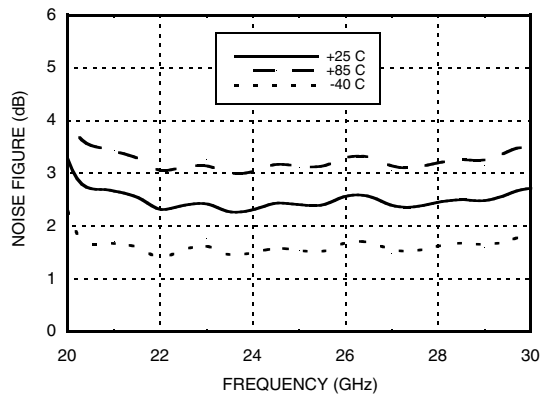

Noise Figure vs. I_{dd}

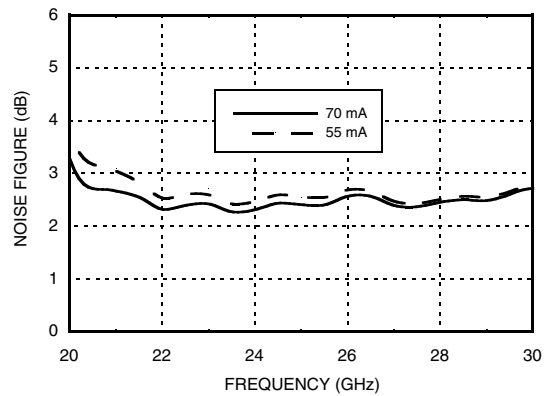



GaAs HEMT MMIC LOW NOISE AMPLIFIER, 24 - 28 GHz

Output IP3 vs. Temperature

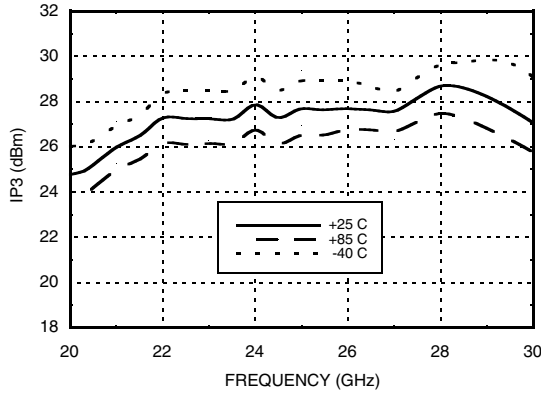

Output IP3 vs. Idd

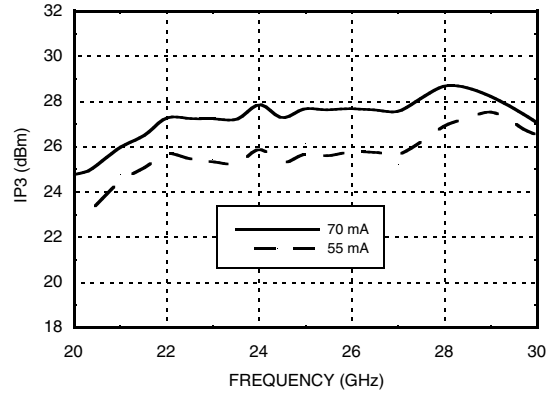

P1dB vs. Temperature

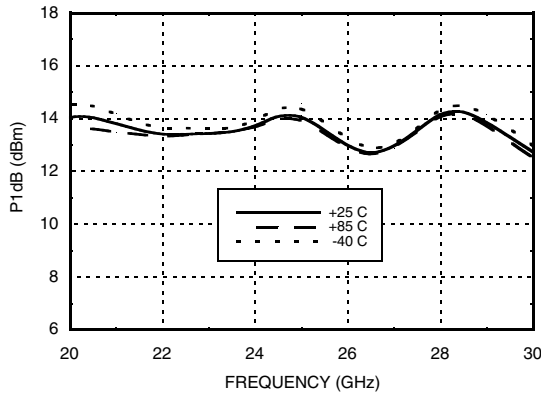

P1dB vs. Idd

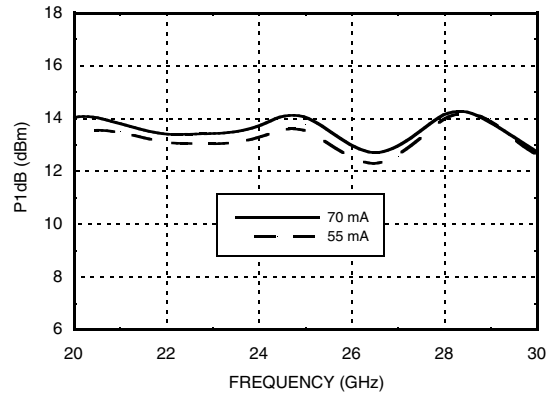

Psat vs. Temperature

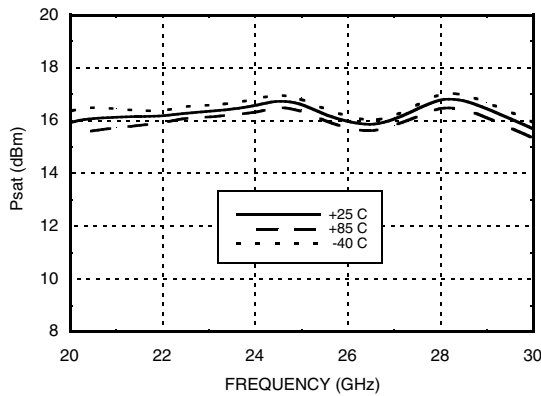

Reverse Isolation vs. Temperature

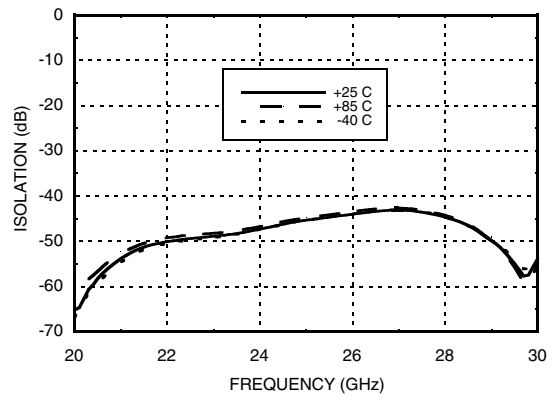

Information furnished by Analog Devices is believed to be accurate and reliable. However, no responsibility is assumed by Analog Devices for its use, nor for any infringements of patents or other rights of third parties that may result from its use. Specifications subject to change without notice. No license is granted by implication or otherwise under any patent or patent rights of Analog Devices. Trademarks and registered trademarks are the property of their respective owners.

For price, delivery, and to place orders: Analog Devices, Inc., One Technology Way, P.O. Box 9106, Norwood, MA 02062-9106 Phone: 781-329-4700 • Order online at www.analog.com Application Support: Phone: 1-800-ANALOG-D

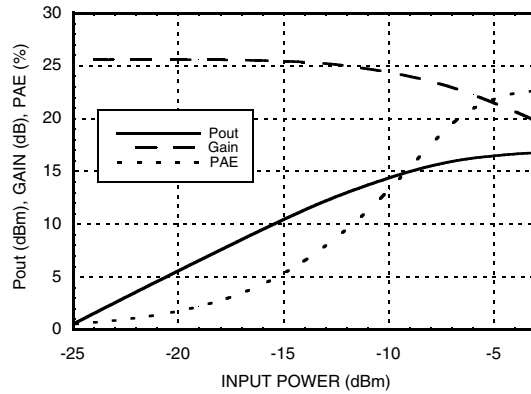
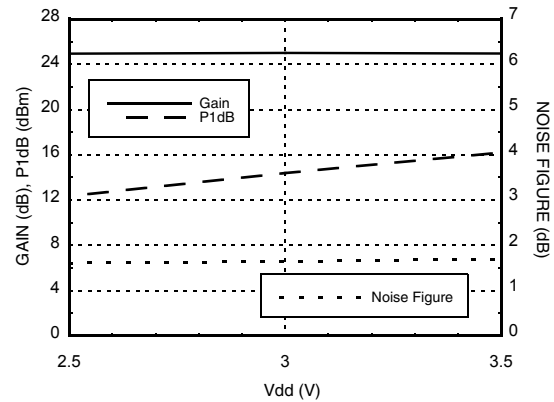
**GaAs HEMT MMIC LOW NOISE
AMPLIFIER, 24 - 28 GHz**
Power Compression @ 28 GHz

**Gain, Noise Figure & P1dB vs.
Supply Voltage @ 28 GHz**

Absolute Maximum Ratings

Drain Bias Voltage	+4.5V
RF Input Power	-5 dBm
Gate Bias Voltage	-1 to 0.3V
Channel Temperature	175 °C
Continuous P _{diss} (T = 85 °C) (derate 6.7 mW/°C above 85 °C)	0.21 W
Thermal Resistance (Channel to ground paddle)	148 °C/W
Storage Temperature	-65 to +150 °C
Operating Temperature	-40 to +85 °C



**ELECTROSTATIC SENSITIVE DEVICE
OBSERVE HANDLING PRECAUTIONS**



GaAs HEMT MMIC LOW NOISE AMPLIFIER, 24 - 28 GHz

Outline Drawing

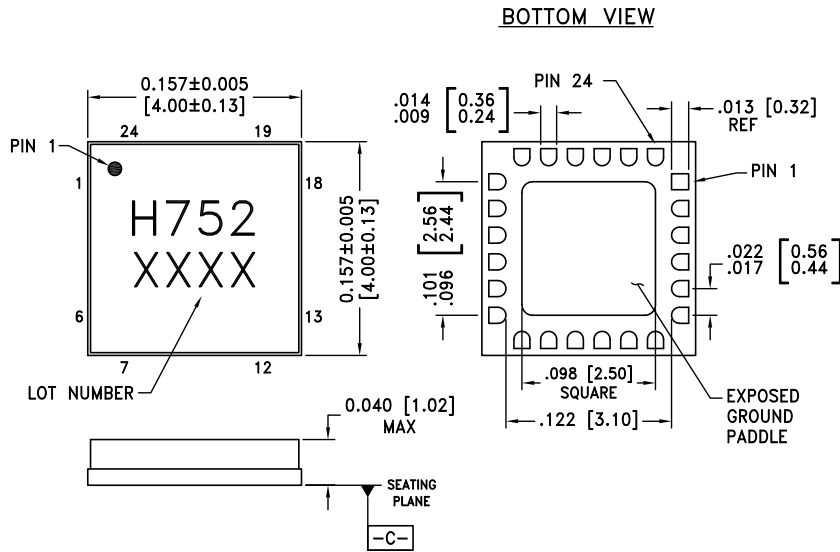

NOTES:

1. PACKAGE BODY MATERIAL: ALUMINA.
2. LEAD AND GROUND PADDLE PLATING: GOLD FLASH OVER NICKEL.
3. DIMENSIONS ARE IN INCHES (MILLIMETERS).
4. LEAD SPACING TOLERANCE IS NON-CUMULATIVE.
5. PACKAGE WARP SHALL NOT EXCEED 0.05MM DATUM \overline{C} .
6. ALL GROUND LEADS AND GROUND PADDLE MUST BE SOLDERED TO PCB RF GROUND.

Package Information

Part Number	Package Body Material	Lead Finish	MSL Rating	Package Marking ^[2]
HMC752LC4	Alumina, White	Gold over Nickel	MSL3 ^[1]	H752 XXXX

[1] Max peak reflow temperature of 260 °C

[2] 4-Digit lot number XXXX

GaAs HEMT MMIC LOW NOISE AMPLIFIER, 24 - 28 GHz



Pin Descriptions

Pin Number	Function	Description	Interface Schematic
1, 2, 4, 6, 7, 12, 13, 15, 17 - 19, 24	GND	Package bottom has exposed metal paddle that must be connected to RF/DC ground.	
3	RFIN	This pad is AC coupled and matched to 50 Ohms.	
5, 11, 14, 22, 23	N/C	No Connection. This pin may be connected to RF/DC ground. Performance will not be affected.	
8 - 10	Vgg1 - 3	Gate control for amplifier. Please follow "MMIC Amplifier Biasing Procedure" application note. See assembly for required external components.	
16	RFOUT	This pad is AC coupled and matched to 50 Ohms.	
21, 20	Vdd1, Vdd2	Power Supply Voltage for the amplifier. See assembly for required external components.	

Application Circuit

Component	Value
C1 - C5	100 pF
C6 - C10	1,000 pF
C11 - C15	4.7 μF

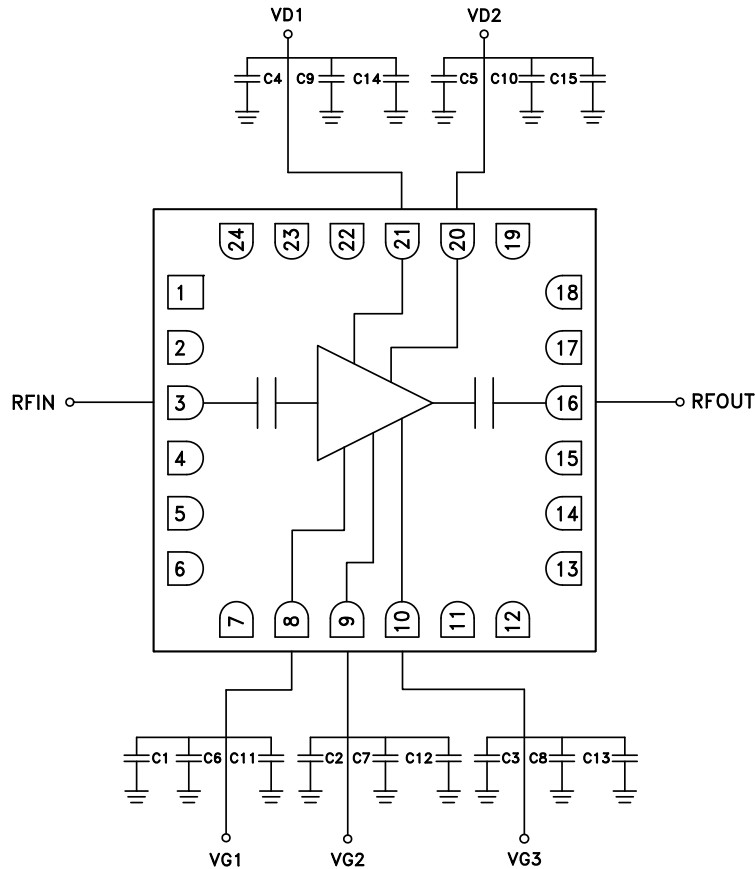

Information furnished by Analog Devices is believed to be accurate and reliable. However, no responsibility is assumed by Analog Devices for its use, nor for any infringements of patents or other rights of third parties that may result from its use. Specifications subject to change without notice. No license is granted by implication or otherwise under any patent or patent rights of Analog Devices. Trademarks and registered trademarks are the property of their respective owners.

For price, delivery, and to place orders: Analog Devices, Inc., One Technology Way, P.O. Box 9106, Norwood, MA 02062-9106 Phone: 781-329-4700 • Order online at www.analog.com Application Support: Phone: 1-800-ANALOG-D



GaAs HEMT MMIC LOW NOISE AMPLIFIER, 24 - 28 GHz

Evaluation PCB

AMPLIFIERS - LOW NOISE - SMT

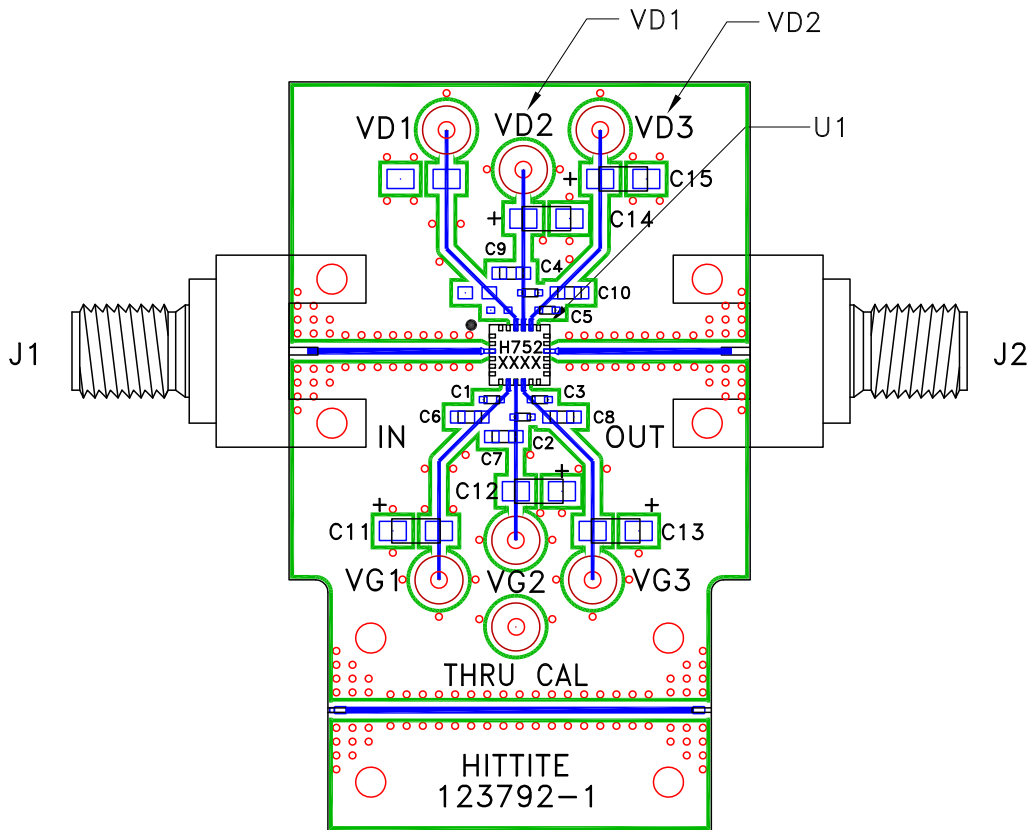

List of Materials for Evaluation PCB 123794 [1]

Item	Description
J1, J2	2.92mm PCB mount K-Connector
J3 - J9	DC Pin
C1 - C5	100pF Capacitor, 0402 Pkg.
C6 - C10	1,000pF Capacitor, 0603 Pkg.
C11 - C15	4.7 μ F Capacitor, Tantalum
U1	HMC752LC4 Amplifier
PCB [2]	123792 Evaluation PCB [2]

[1] Reference this number when ordering complete evaluation PCB

[2] Circuit Board Material: Rogers 4350 or Arlon 25FR

The circuit board used in this application should use RF circuit design techniques. Signal lines should have 50 Ohm impedance while the package ground leads and exposed paddle should be connected directly to the ground plane similar to that shown. A sufficient number of via holes should be used to connect the top and bottom ground planes. The evaluation board should be mounted to an appropriate heat sink. The evaluation circuit board shown is available from Hittite upon request.

**GaAs HEMT MMIC LOW NOISE
AMPLIFIER, 24 - 28 GHz**