



Chipsmall Limited consists of a professional team with an average of over 10 year of expertise in the distribution of electronic components. Based in Hongkong, we have already established firm and mutual-benefit business relationships with customers from,Europe,America and south Asia,supplying obsolete and hard-to-find components to meet their specific needs.

With the principle of “Quality Parts,Customers Priority,Honest Operation,and Considerate Service”,our business mainly focus on the distribution of electronic components. Line cards we deal with include Microchip,ALPS,ROHM,Xilinx,Pulse,ON,Everlight and Freescale. Main products comprise IC,Modules,Potentiometer,IC Socket,Relay,Connector.Our parts cover such applications as commercial,industrial, and automotives areas.

We are looking forward to setting up business relationship with you and hope to provide you with the best service and solution. Let us make a better world for our industry!



Contact us

Tel: +86-755-8981 8866 Fax: +86-755-8427 6832

Email & Skype: info@chipsmall.com Web: www.chipsmall.com

Address: A1208, Overseas Decoration Building, #122 Zhenhua RD., Futian, Shenzhen, China



FEATURES

Downconverter

- Conversion loss: 10 dB (typical)
- LO to RF isolation: 39 dB (typical)
- LO to IF isolation: 33 dB (typical)
- RF to IF isolation: 18 dB (typical)
- Input IP3: 21 dBm (typical)
- Input IP2: 46 dBm (typical)
- P1dB: 12 dBm (typical)
- IF bandwidth: dc to 10 GHz
- Passive: no dc bias required
- Small size: 1.290 mm × 0.880 mm × 0.102 mm

APPLICATIONS

- Point to point radios
- Point to multipoint radios and very small aperture terminals (VSATs)
- Test equipment and sensors
- Military end use

GENERAL DESCRIPTION

The HMC773A is a general-purpose, double balanced mixer chip that can be used as an upconverter or downconverter from 6 GHz to 26 GHz. This mixer requires no external components or matching circuitry.

FUNCTIONAL BLOCK DIAGRAM

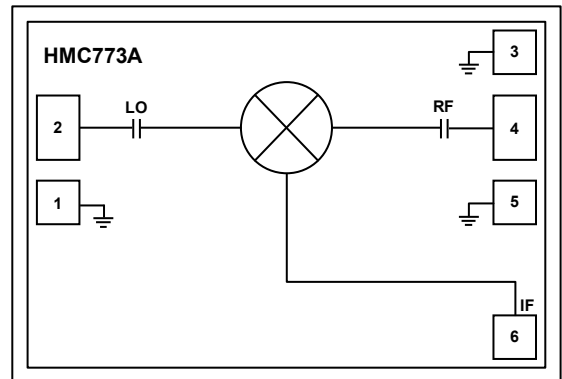

Figure 1.

The HMC773A provides excellent local oscillator (LO) to radio frequency (RF) and LO to intermediate frequency (IF) suppression due to optimized balun structures. The mixer operates well with LO drive levels of 13 dBm or greater. The HMC773A is also available in surface-mount technology format as the [HMC773ALC3B](#).

TABLE OF CONTENTS

Features	1	Downconverter, Lower Sideband, IF = 3000 MHz	11
Applications	1	Downconverter, Lower Sideband, IF = 7000 MHz	12
Functional Block Diagram	1	Downconverter, P1dB Performance	13
General Description	1	Upconverter, Upper Sideband	14
Revision History	2	Upconverter, Lower Sideband	15
Specifications	3	Spurious Performance	16
Electrical Specifications	3	Theory of Operation	19
Absolute Maximum Ratings	4	Applications Information	20
Thermal Resistance	4	Typical Application Circuit	20
ESD Caution	4	Assembly Diagram	20
Pin Configuration and Function Descriptions	5	Mounting and Bonding Techniques for Millimeter Wave GaAs MMICs	21
Interface Schematics	5	Handling Precautions	21
Typical Performance Characteristics	6	Mounting	21
Downconverter, Upper Sideband, IF = 500 MHz	6	Wire Bonding	21
Downconverter, Upper Sideband, IF = 3000 MHz	8	Outline Dimensions	22
Downconverter, Upper Sideband, IF = 7000 MHz	9	Ordering Guide	22
Downconverter, Lower Sideband, IF = 500 MHz	10		

REVISION HISTORY

8/2018—Rev. 0 to Rev. A

Changes to Table 5, Figure 4, and Figure 6

5

6/2018—Revision 0: Initial Version

SPECIFICATIONS

ELECTRICAL SPECIFICATIONS

$T_A = 25^\circ\text{C}$, IF = 500 MHz, LO drive level = 13 dBm, RF frequency range = 6 GHz to 16 GHz, all measurements performed as a downconverter with the upper sideband selected, unless otherwise noted.

Table 1.

Parameter	Symbol	Min	Typ	Max	Unit
FREQUENCY RANGE					
Radio Frequency	RF	6		16	GHz
Local Oscillator	LO	6		16	GHz
Intermediate Frequency	IF	dc		10	GHz
CONVERSION LOSS			9.5	12	dB
NOISE FIGURE			10.5		dB
ISOLATION					
LO to RF			37		dB
LO to IF		29	35		dB
RF to IF		8	13		dB
INPUT THIRD-ORDER INTERCEPT	IP3	11	19		dBm
INPUT SECOND-ORDER INTERCEPT	IP2		43		dBm
INPUT POWER					
1 dB Compression	P1dB		10.5		dBm
RETURN LOSS					
RF Port			13		dB
LO Port			14.5		dB

$T_A = 25^\circ\text{C}$, IF = 500 MHz, LO drive = 13 dBm, RF frequency range = 16 GHz to 26 GHz, all measurements performed as a downconverter with the upper sideband selected, unless otherwise noted.

Table 2.

Parameter	Symbol	Min	Typ	Max	Unit
FREQUENCY RANGE					
Radio Frequency	RF	16		26	GHz
Local Oscillator	LO	16		26	GHz
Intermediate Frequency	IF	dc		10	GHz
CONVERSION LOSS			10	13	dB
NOISE FIGURE			10		dB
ISOLATION					
LO to RF			39		dB
LO to IF		21	33		dB
RF to IF		11	18		dB
INPUT THIRD-ORDER INTERCEPT	IP3	18	21		dBm
INPUT SECOND-ORDER INTERCEPT	IP2		46		dBm
INPUT POWER					
1 dB Compression	P1dB		12		dBm
RETURN LOSS					
RF Port			8		dB
LO Port			13.5		dB

ABSOLUTE MAXIMUM RATINGS

Table 3.

Parameter	Rating
RF Input Power	21 dBm
LO Input Power	21 dBm
IF Input Power	21 dBm
IF Source/Sink Current	2 mA
Channel Temperature	175°C
Continuous P _{DISS} (T _A = 85°C) (Derate 4.44 mW/°C Above 85°C)	400 mW
Storage Temperature Range	–65°C to +150°C
Operating Temperature Range	–55°C to +85°C
Electrostatic Discharge (ESD) Sensitivity	
Human Body Model (HBM)	2000 V
Field Induced Charged Device Model (FICDM)	1200 V

Stresses at or above those listed under Absolute Maximum Ratings may cause permanent damage to the product. This is a stress rating only; functional operation of the product at these or any other conditions above those indicated in the operational section of this specification is not implied. Operation beyond the maximum operating conditions for extended periods may affect product reliability.

THERMAL RESISTANCE

θ_{JC} is the junction to case thermal resistance, channel to bottom of die.

Table 4. Thermal Resistance

Package Type	θ_{JC}	Unit
C-6-12	225	°C/W

ESD CAUTION



ESD (electrostatic discharge) sensitive device. Charged devices and circuit boards can discharge without detection. Although this product features patented or proprietary protection circuitry, damage may occur on devices subjected to high energy ESD. Therefore, proper ESD precautions should be taken to avoid performance degradation or loss of functionality.

PIN CONFIGURATION AND FUNCTION DESCRIPTIONS



Figure 2. Pin Configuration

Table 5. Pin Function Descriptions

Pin No.	Mnemonic	Description
1, 3, 5, Die Bottom	GND	Ground. Connect these pads to RF/dc ground. See Figure 3 for the GND interface schematic.
2	LO	Local Oscillator Port. This pad is dc-coupled and matched to 50 Ω. See Figure 4 for the LO interface schematic.
4	RF	Radio Frequency Port. This pad is dc-coupled and matched to 50 Ω. See Figure 6 for the RF interface schematic.
6	IF	Intermediate Frequency Port. This pad is dc-coupled. For applications not requiring operation to dc, block this pin externally using a series capacitor with a value that passes the necessary IF frequency range. For operation to dc, to prevent device malfunction or failure, this pin must not source or sink more than 2 mA of current. See Figure 5 for the IF interface schematic.

INTERFACE SCHEMATICS



Figure 3. GND Interface Schematic

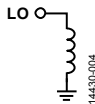

Figure 4. LO Interface Schematic

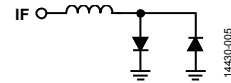

Figure 5. IF Interface Schematic

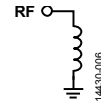

Figure 6. RF Interface Schematic

TYPICAL PERFORMANCE CHARACTERISTICS

DOWNCONVERTER, UPPER SIDEBAND, IF = 500 MHz

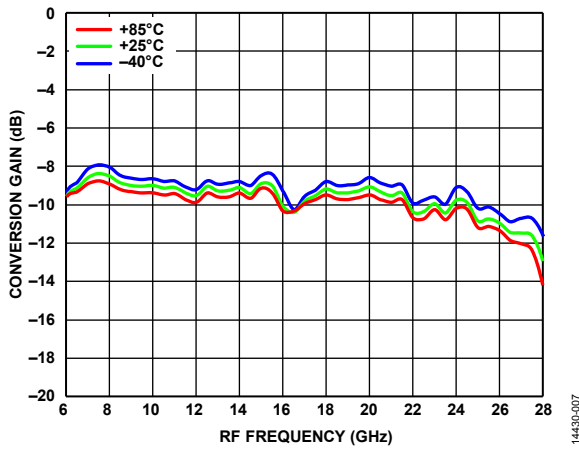

Figure 7. Conversion Gain vs. RF Frequency at Various Temperatures, LO Drive = 13 dBm

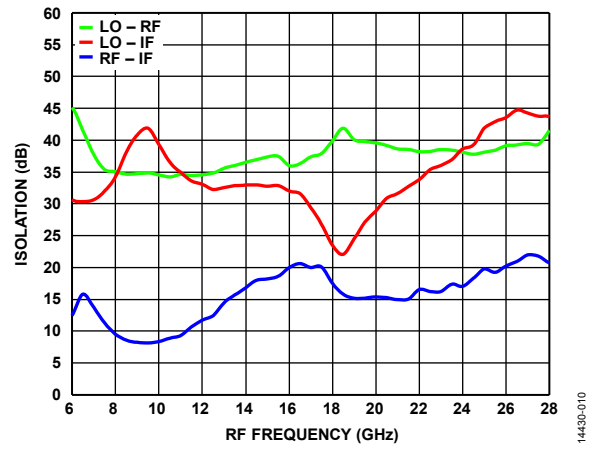

Figure 10. Isolation vs. RF Frequency

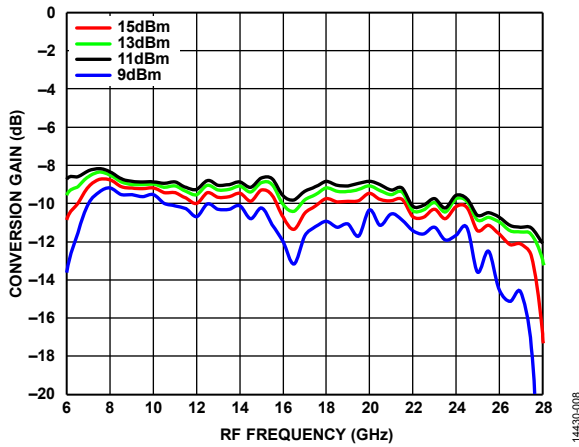

Figure 8. Conversion Gain vs. RF Frequency at Various LO Drives

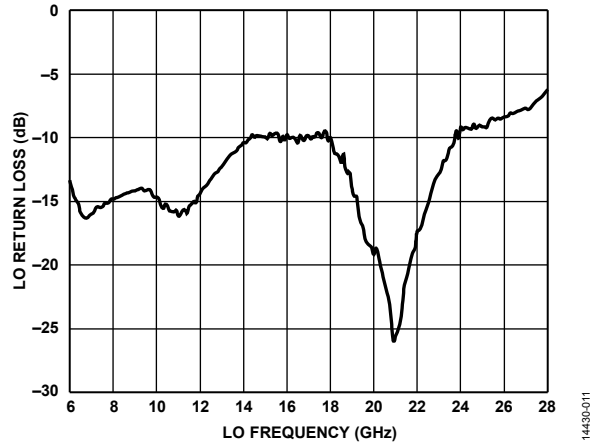

Figure 11. LO Return Loss vs. LO Frequency, LO Drive = 13 dBm

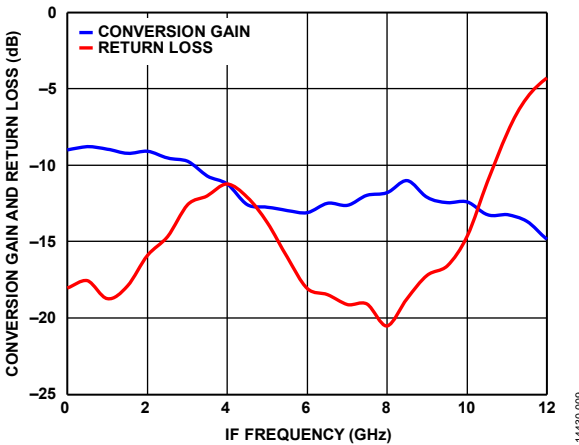

Figure 9. Conversion Gain and Return Loss vs. IF Frequency, LO Drive = 13 dBm

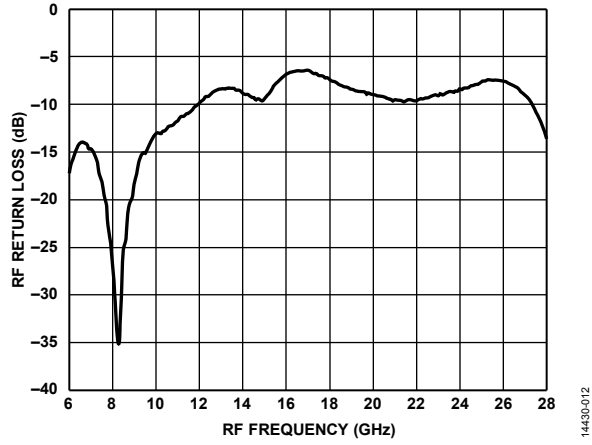

Figure 12. RF Return Loss vs. RF Frequency, LO Frequency = 16 GHz, LO Drive = 13 dBm

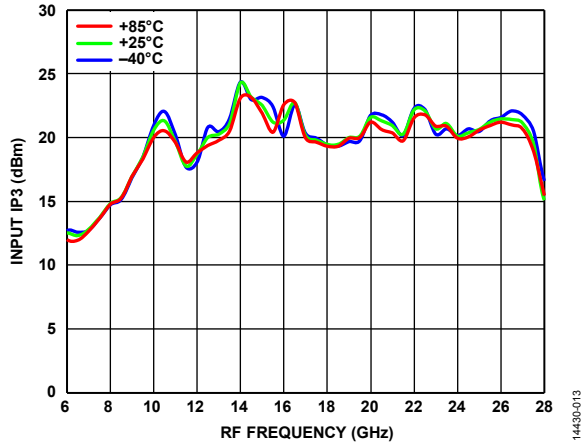

Figure 13. Input IP3 vs. RF Frequency at Various Temperatures, LO Drive = 13 dBm

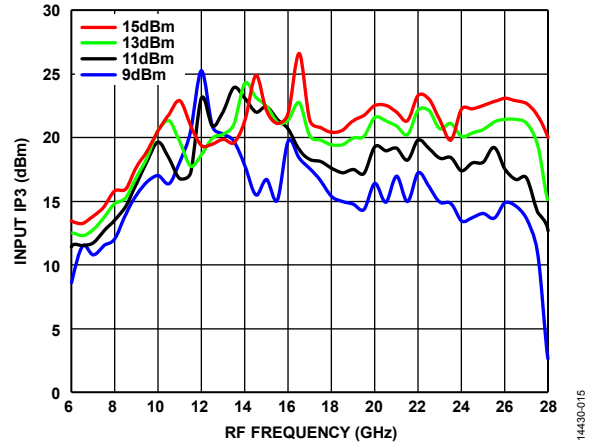

Figure 16. Input IP3 vs. RF Frequency at Various LO Drives

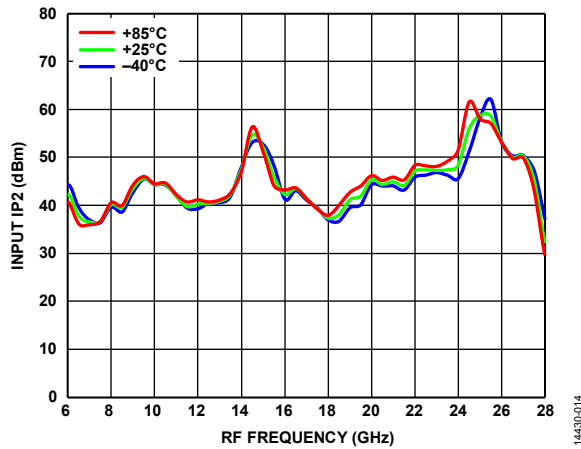

Figure 14. Input IP2 vs. RF Frequency at Various Temperatures, LO Drive = 13 dBm

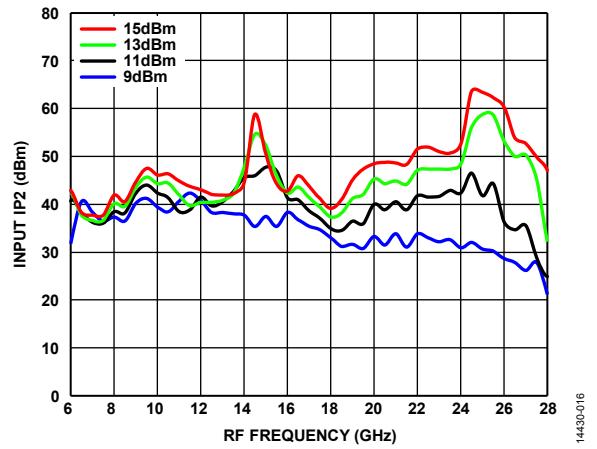

Figure 17. Input IP2 vs. RF Frequency at Various LO Drives

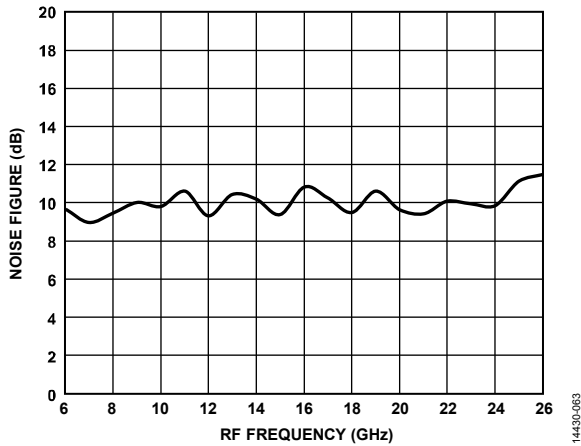

Figure 15. Noise Figure vs. RF Frequency, LO Drive = 13 dBm (Without LO Amplifier in Line with Lab Bench LO Source)

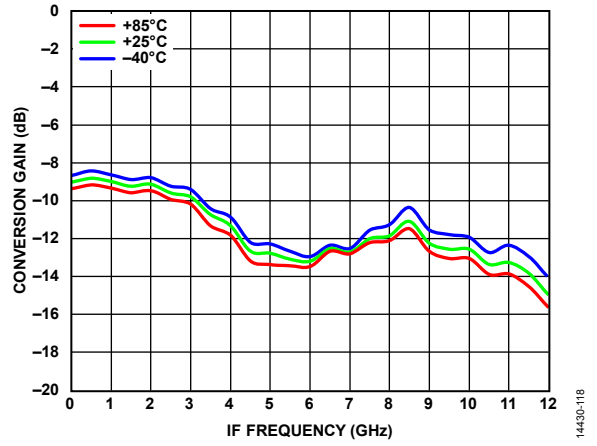

Figure 18. Conversion Gain vs. IF Frequency at Various Temperatures

DOWNCONVERTER, UPPER SIDEBAND, IF = 3000 MHz

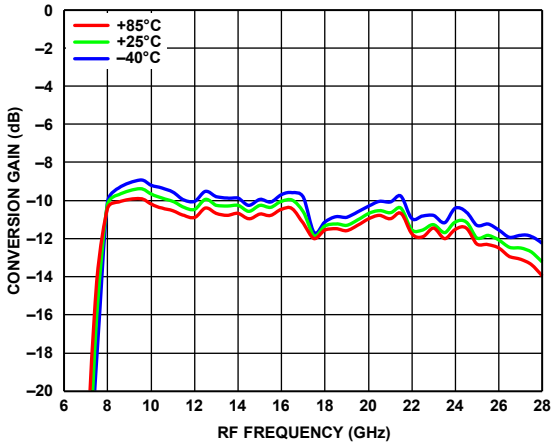

Figure 19. Conversion Gain vs. RF Frequency at Various Temperatures, LO Drive = 13 dBm

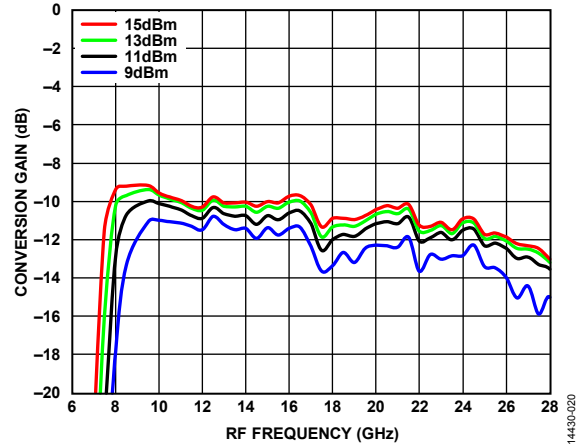

Figure 22. Conversion Gain vs. RF Frequency at Various LO Drives

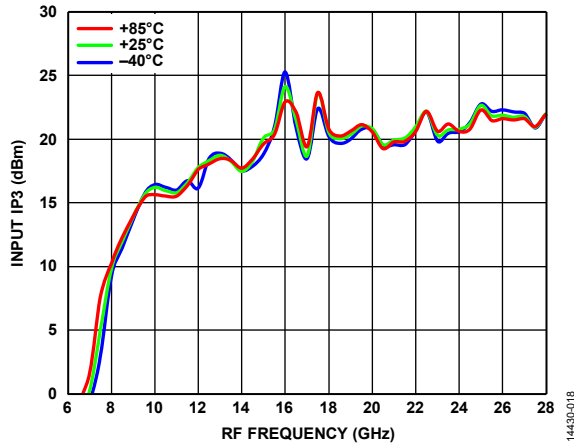

Figure 20. Input IP3 vs. RF Frequency at Various Temperatures, LO Drive = 13 dBm

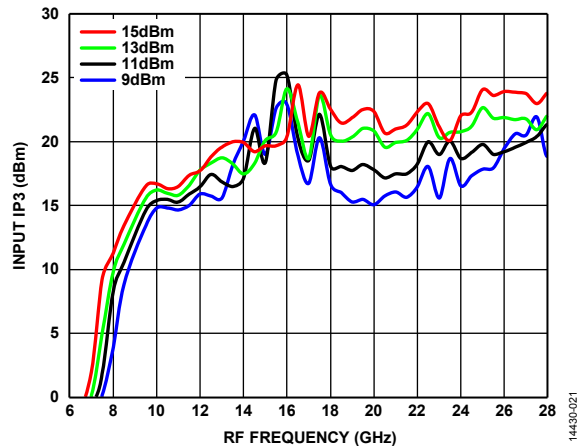

Figure 23. Input IP3 vs. RF Frequency at Various LO Drives

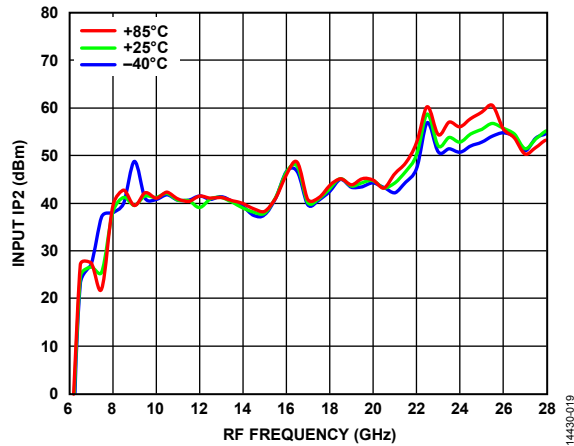

Figure 21. Input IP2 vs. RF Frequency at Various Temperatures, LO Drive = 13 dBm

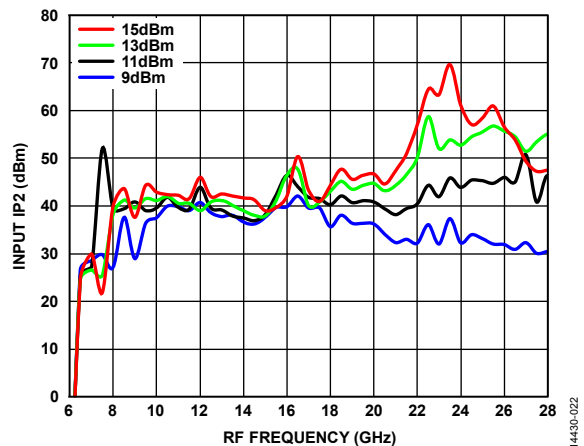

Figure 24. Input IP2 vs. RF Frequency at Various LO Drives

DOWNCONVERTER, UPPER SIDEBAND, IF = 7000 MHz

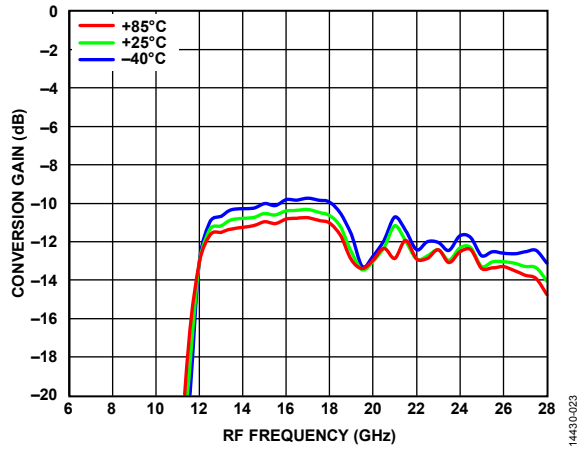

Figure 25. Conversion Gain vs. RF Frequency at Various Temperatures, LO Drive = 13 dBm

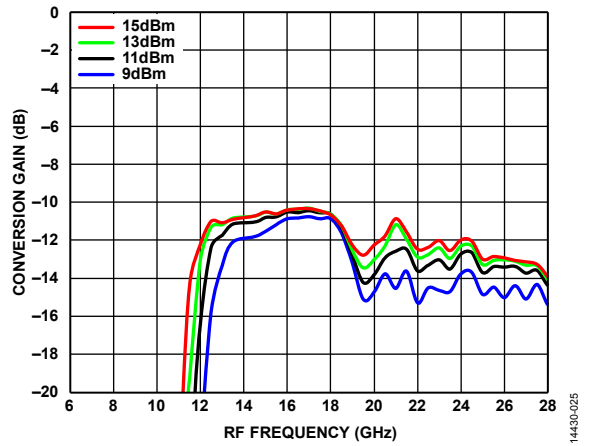

Figure 27. Conversion Gain vs. RF Frequency at Various LO Drives

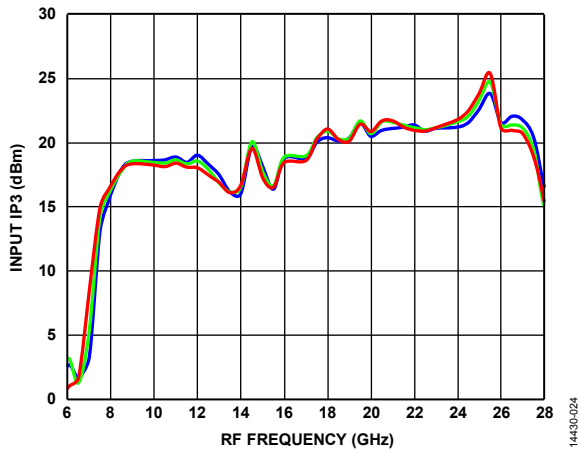

Figure 26. Input IP3 vs. RF Frequency at Various Temperatures, LO Drive = 13 dBm

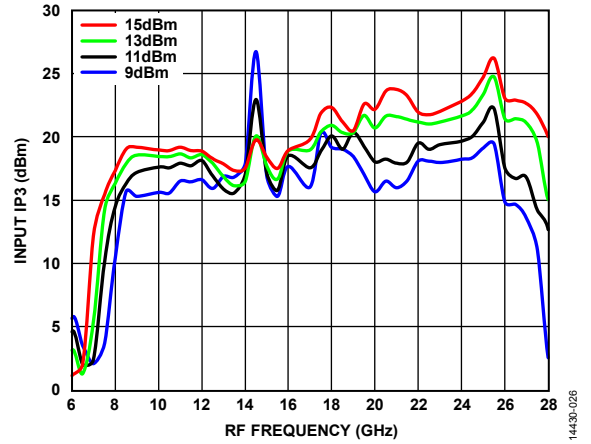

Figure 28. Input IP3 vs. RF Frequency at Various LO Drives

DOWNCONVERTER, LOWER SIDEBAND, IF = 500 MHZ

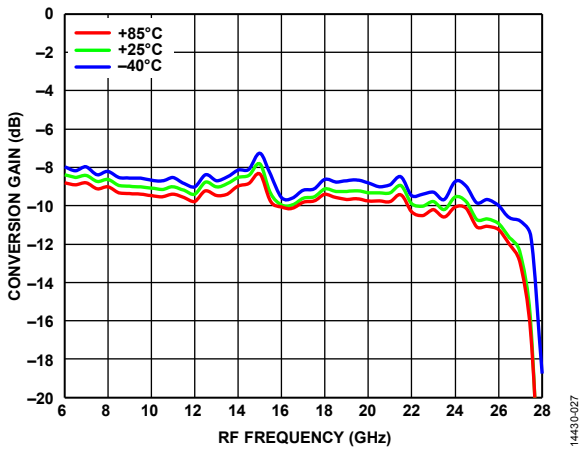

Figure 29. Conversion Gain vs. RF Frequency at Various Temperatures, LO Drive = 13 dBm

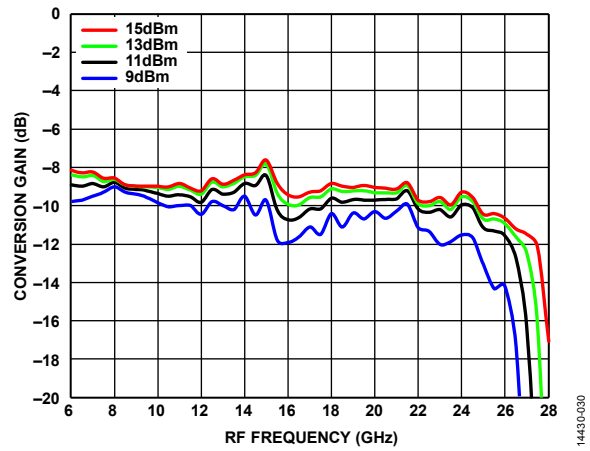

Figure 32. Conversion Gain vs. RF Frequency at Various LO Drives

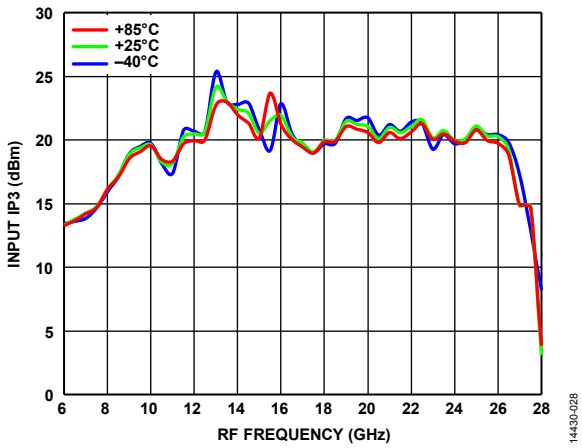

Figure 30. Input IP3 vs. RF Frequency at Various Temperatures, LO Drive = 13 dBm

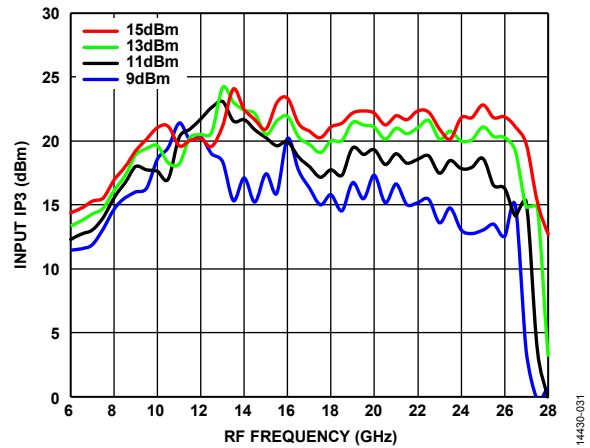

Figure 33. Input IP3 vs. RF Frequency at Various LO Drives

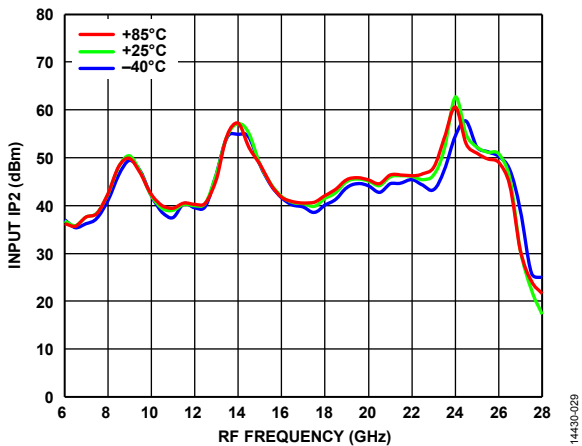

Figure 31. Input IP2 vs. RF Frequency at Various Temperatures, LO Drive = 13 dBm

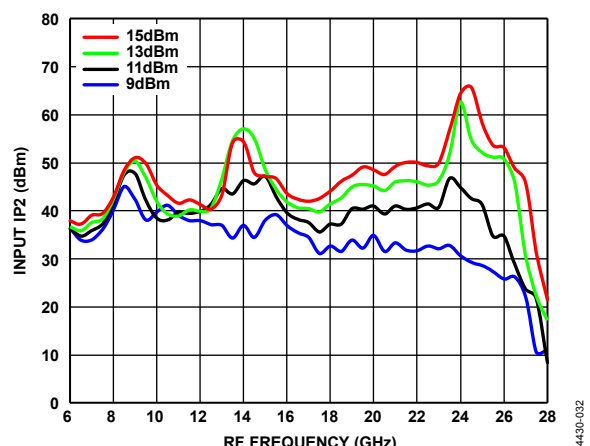

Figure 34. Input IP2 vs. RF Frequency at Various LO Drives

DOWNCONVERTER, LOWER SIDEBAND, IF = 3000 MHz

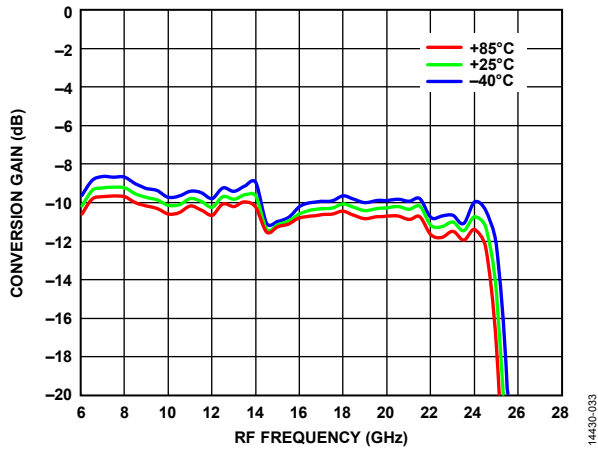

Figure 35. Conversion Gain vs. RF Frequency at Various Temperatures, LO Drive = 13 dBm

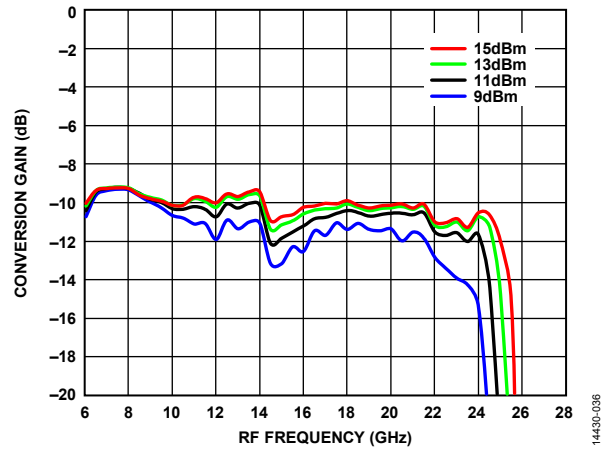

Figure 38. Conversion Gain vs. RF Frequency at Various LO Drives

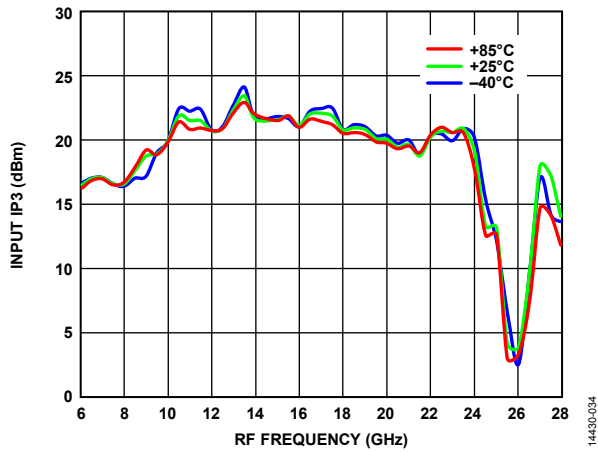

Figure 36. Input IP3 vs. RF Frequency at Various Temperatures, LO Drive = 13 dBm

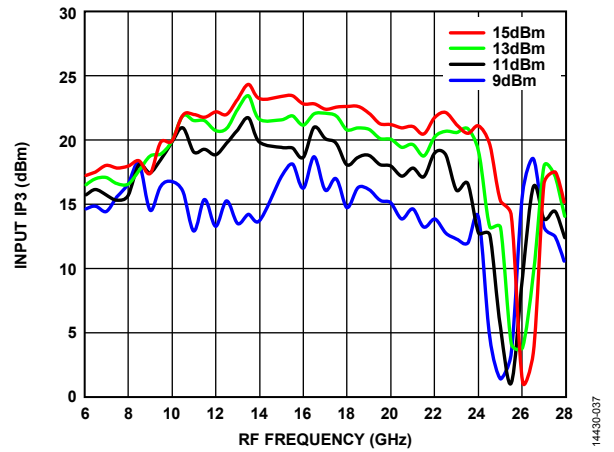

Figure 39. Input IP3 vs. RF Frequency at Various LO Drives

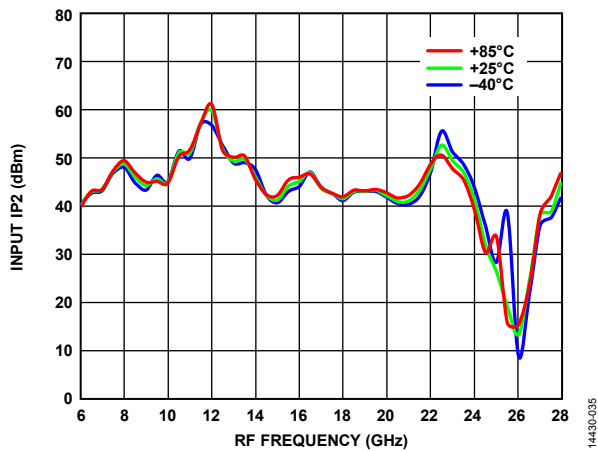

Figure 37. Input IP2 vs. RF Frequency at Various Temperatures, LO Drive = 13 dBm

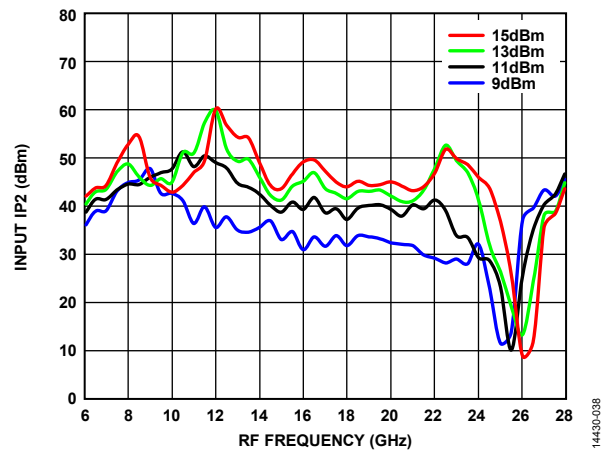

Figure 40. Input IP2 vs. RF Frequency at Various LO Drives

DOWNCONVERTER, LOWER SIDEBAND, IF = 7000 MHz

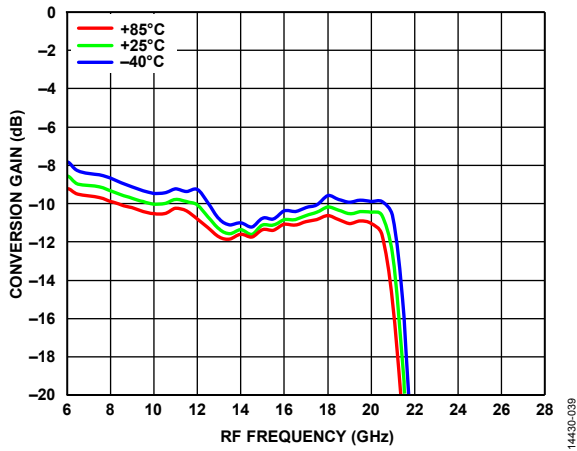

Figure 41. Conversion Gain vs. RF Frequency at Various Temperatures, LO Drive = 13 dBm

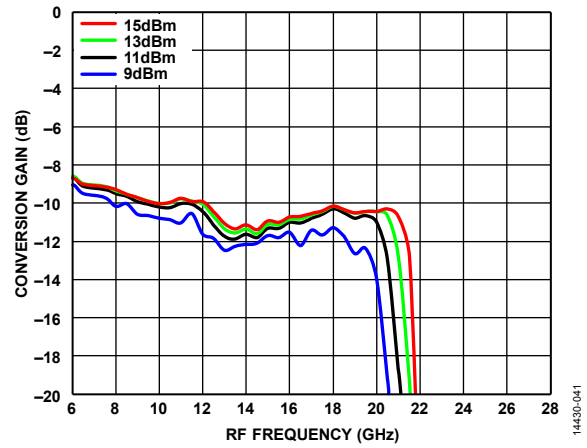

Figure 43. Conversion Gain vs. RF Frequency at Various LO Drives

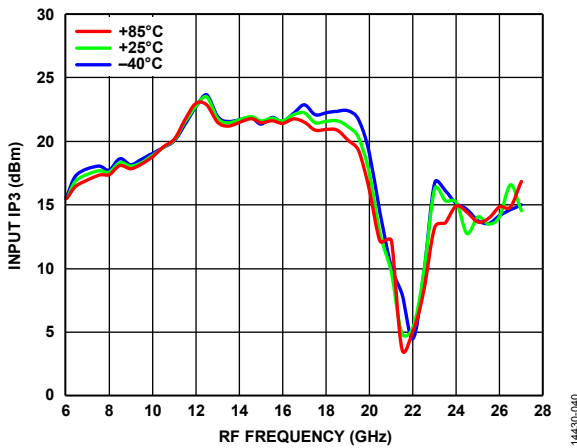

Figure 42. Input IP3 vs. RF Frequency at Various Temperatures, LO Drive = 13 dBm

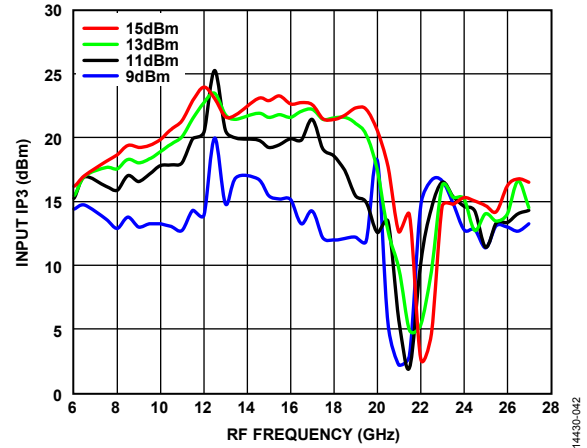

Figure 44. Input IP3 vs. RF Frequency at Various LO Drives

DOWNCONVERTER, P1dB PERFORMANCE

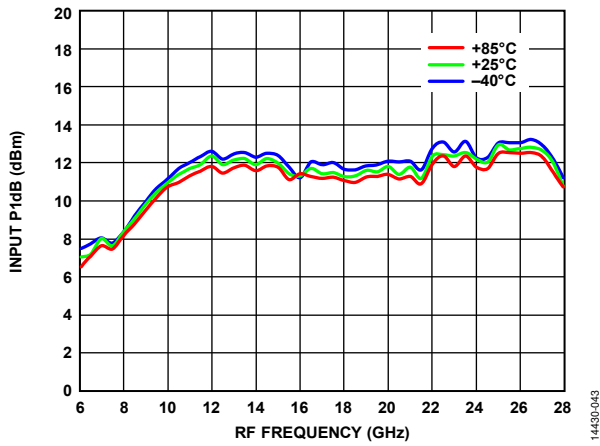

Figure 45. Input P1dB vs. RF Frequency at Various Temperatures, IF = 500 MHz, LO Drive = 13 dBm, Upper Sideband

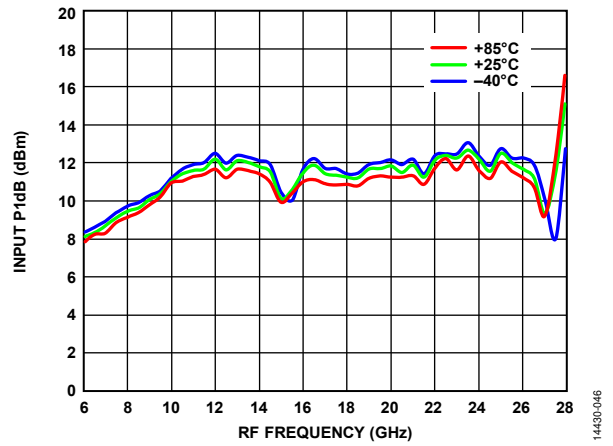

Figure 48. Input P1dB vs. RF Frequency at Various Temperatures, IF = 500 MHz, LO Drive = 13 dBm, Lower Sideband

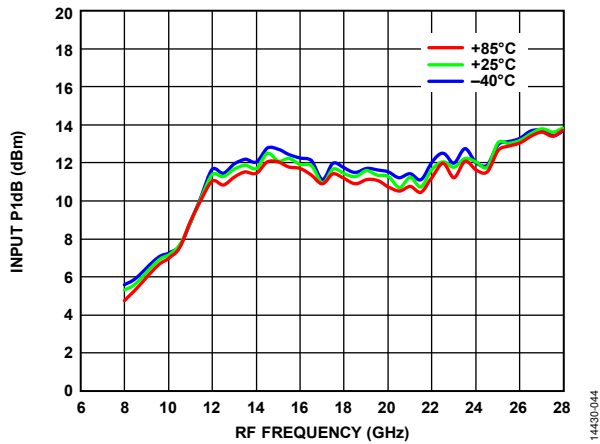

Figure 46. Input P1dB vs. RF Frequency at Various Temperatures, IF = 3000 MHz, LO Drive = 13 dBm, Upper Sideband

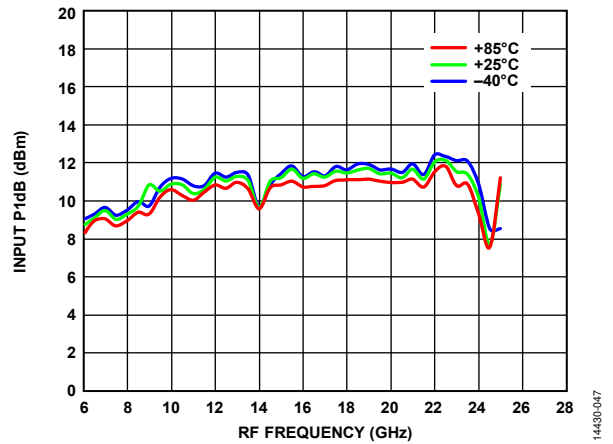

Figure 49. Input P1dB vs. RF Frequency at Various Temperatures, IF = 3000 MHz, LO Drive = 13 dBm, Lower Sideband

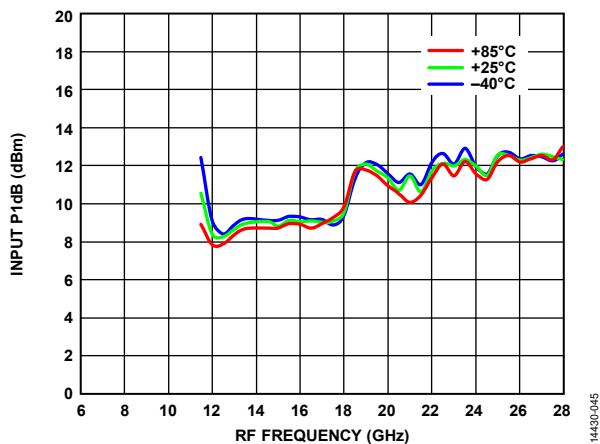

Figure 47. Input P1dB vs. RF Frequency at Various Temperatures, IF = 7000 MHz, LO Drive = 13 dBm, Upper Sideband

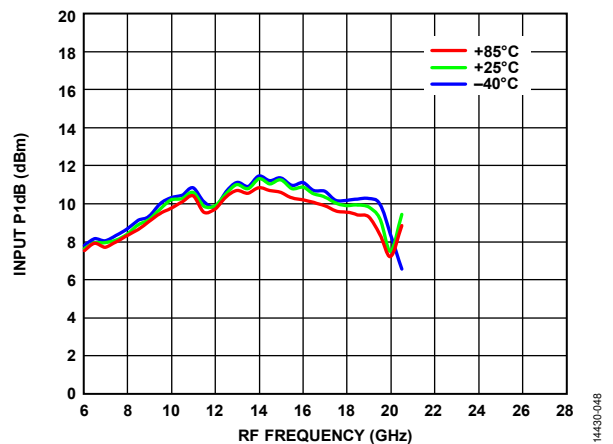

Figure 50. Input P1dB vs. RF Frequency at Various Temperatures, IF = 7000 MHz, LO Drive = 13 dBm, Lower Sideband

UPCONVERTER, UPPER SIDEBAND

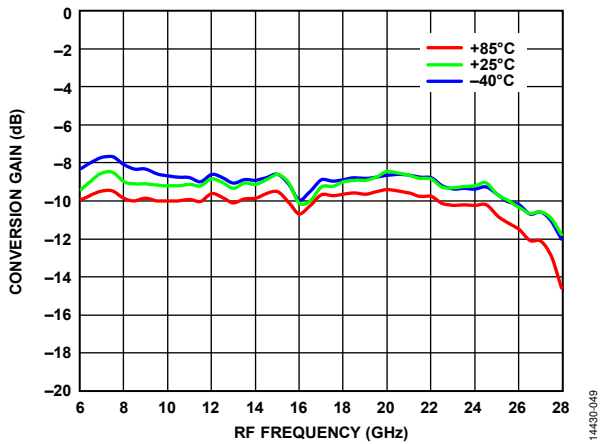

Figure 51. Conversion Gain vs. RF Frequency at Various Temperatures, LO Drive = 13 dBm, IF = 500 MHz

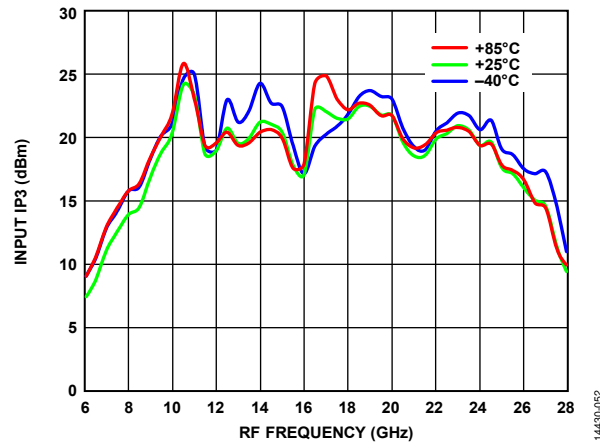

Figure 54. Input IP3 vs. RF Frequency at Various Temperatures, LO Drive = 13 dBm, IF = 500 MHz

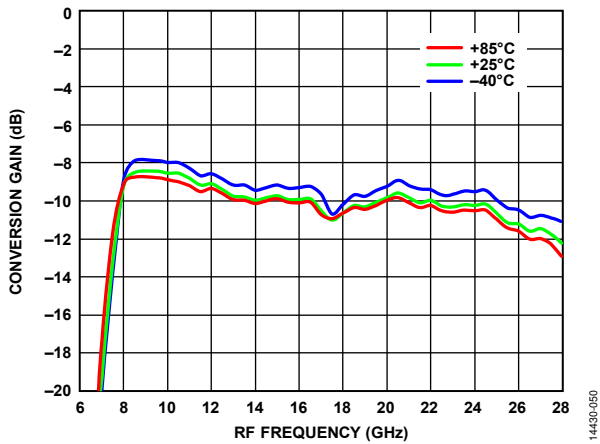

Figure 52. Conversion Gain vs. RF Frequency at Various Temperatures, LO Drive = 13 dBm, IF = 3000 MHz

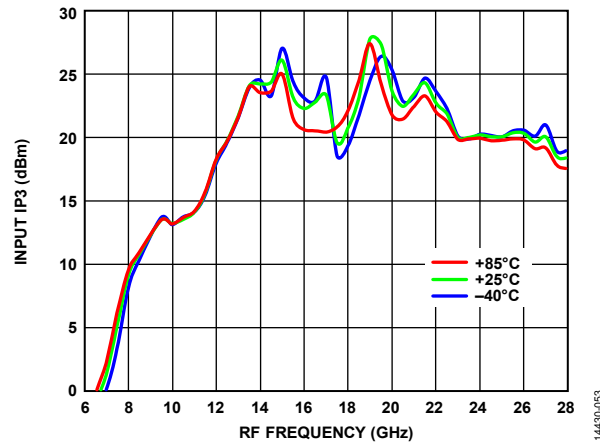

Figure 55. Input IP3 vs. RF Frequency at Various Temperatures, LO Drive = 13 dBm, IF = 3000 MHz

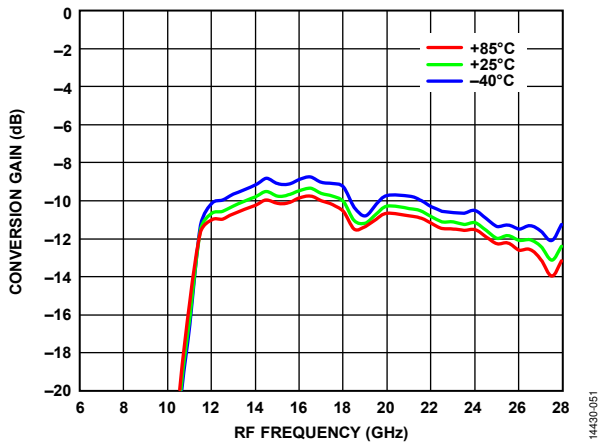

Figure 53. Conversion Gain vs. RF Frequency at Various Temperatures, LO Drive = 13 dBm, IF = 7000 MHz

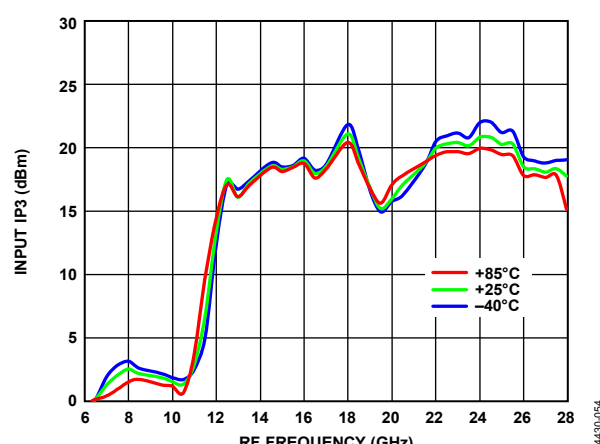

Figure 56. Input IP3 vs. RF Frequency at Various Temperatures, LO Drive = 13 dBm, IF = 7000 MHz

UPCONVERTER, LOWER SIDEBAND

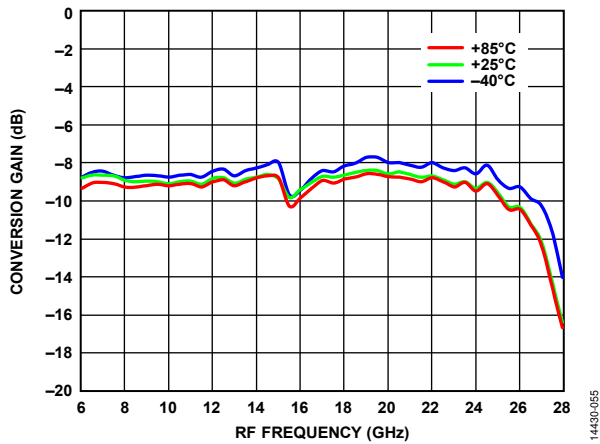

Figure 57. Conversion Gain vs. RF Frequency at Various Temperatures, LO Drive = 13 dBm, IF = 500 MHz

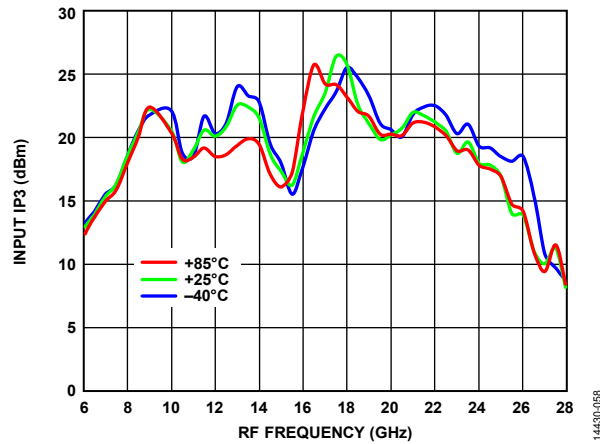

Figure 60. Input IP3 vs. RF Frequency at Various Temperatures, LO Drive = 13 dBm, IF = 500 MHz

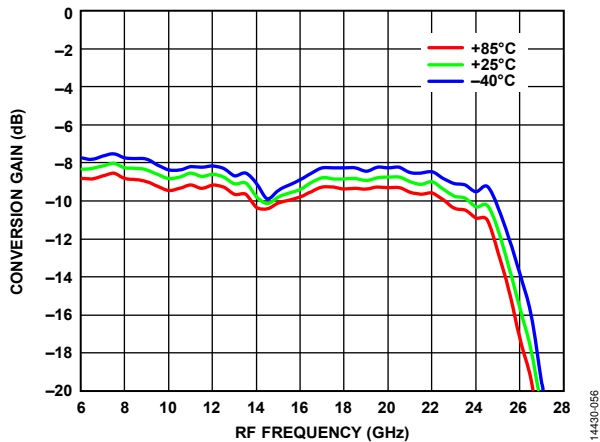

Figure 58. Conversion Gain vs. RF Frequency at Various Temperatures, LO Drive = 13 dBm, IF = 3000 MHz

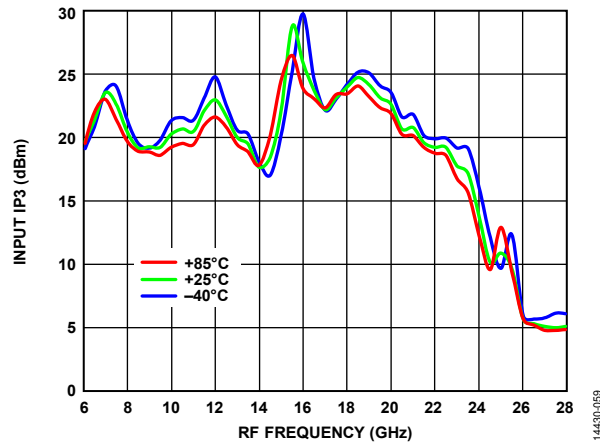

Figure 61. Input IP3 vs. RF Frequency at Various Temperatures, LO Drive = 13 dBm, IF = 3000 MHz

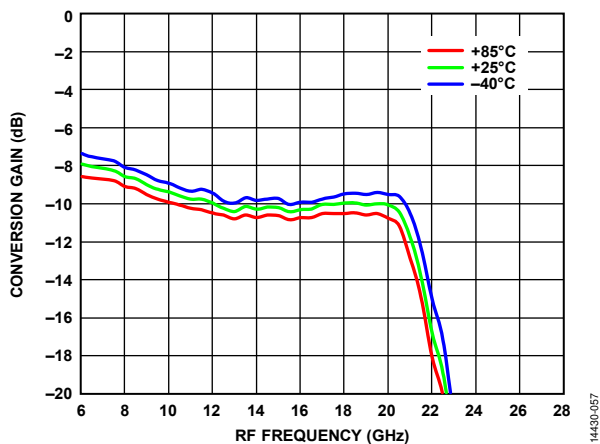

Figure 59. Conversion Gain vs. RF Frequency at Various Temperatures, LO Drive = 13 dBm, IF = 7000 MHz

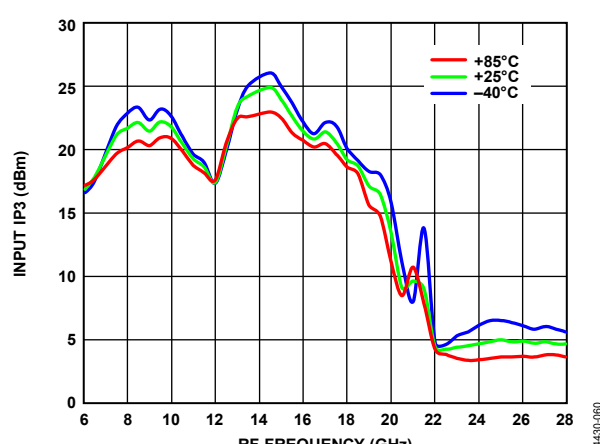

Figure 62. Input IP3 vs. RF Frequency at Various Temperatures, LO Drive = 13 dBm, IF = 7000 MHz

SPURIOUS PERFORMANCE

Downconversion, Upper Sideband

Spur values are $(M \times RF) - (N \times LO)$. Mixer spurious products are measured in dBc from the IF output power level. N/A means not applicable.

M × N Spurious Outputs, IF = 500 MHz

RF frequency = 9 GHz and RF input power = -10 dBm.
LO frequency = 8.5 GHz and LO input power = 13 dBm.

		N × LO					
		0	1	2	3	4	5
M × RF	0	N/A	+9	+30	+26	+47	N/A
	1	-1	0	+18	+29	+35	+51
	2	+58	+56	+57	+63	+73	+72
	3	+76	+87	+63	+63	+61	+87
	4	+79	+83	+85	+89	+96	+90
	5	N/A	+79	+83	+85	+90	+93

RF frequency = 18 GHz and RF input power = -10 dBm.
LO frequency = 17.5 GHz and LO input power = 13 dBm.

		N × LO					
		0	1	2	3	4	5
M × RF	0	N/A	-9	+41	N/A	N/A	N/A
	1	+9	0	+33	+49	N/A	N/A
	2	+80	+60	+54	+64	+81	N/A
	3	N/A	+79	+87	+69	+84	+80
	4	N/A	N/A	+82	+87	+96	+88
	5	N/A	N/A	N/A	+79	+83	+94

RF frequency = 26 GHz and RF input power = -10 dBm.
LO frequency = 25.5 GHz and LO input power = 13 dBm.

		N × LO					
		0	1	2	3	4	5
M × RF	0	N/A	10	N/A	N/A	N/A	N/A
	1	10	0	36	N/A	N/A	N/A
	2	N/A	59	74	74	N/A	N/A
	3	N/A	N/A	83	81	85	N/A
	4	N/A	N/A	N/A	N/A	82	94
	5	N/A	N/A	N/A	N/A	N/A	83

M × N Spurious Outputs, IF = 1000 MHz

RF frequency = 9 GHz and RF input power = -10 dBm.
LO frequency = 8 GHz and LO input power = 13 dBm.

		N × LO					
		0	1	2	3	4	5
M × RF	0	N/A	+5	+27	+39	+43	N/A
	1	-1	0	+19	+25	+35	+45
	2	+57	+56	+57	+56	+72	+72
	3	+76	+85	+64	+66	+61	+80
	4	+79	+83	+87	+88	+87	+88
	5	N/A	+78	+78	+75	+79	+61

RF frequency = 18 GHz and RF input power = -10 dBm.
LO frequency = 17 GHz and LO input power = 13 dBm.

		N × LO					
		0	1	2	3	4	5
M × RF	0	N/A	-6	+39	N/A	N/A	N/A
	1	+9	0	+29	+46	N/A	N/A
	2	+80	+63	+54	+66	+79	N/A
	3	N/A	+79	+84	+69	+79	+83
	4	N/A	N/A	+78	+87	+89	+90
	5	N/A	N/A	N/A	+77	+86	+91

RF frequency = 26 GHz and RF input power = -10 dBm.
LO frequency = 25 GHz and LO input power = 13 dBm.

		N × LO					
		0	1	2	3	4	5
M × RF	0	N/A	10	N/A	N/A	N/A	N/A
	1	10	0	37	N/A	N/A	N/A
	2	N/A	60	76	73	N/A	N/A
	3	N/A	N/A	82	77	86	N/A
	4	N/A	N/A	N/A	80	85	86
	5	N/A	N/A	N/A	N/A	81	89

Downconversion, Lower Sideband

Spur values are $(M \times RF) - (N \times LO)$. Mixer spurious products are measured in dBc from the IF output power level. N/A means not applicable.

M × N Spurious Outputs, IF = 500 MHz

RF frequency = 9 GHz and RF input power = -10 dBm.
LO frequency = 9.5 GHz and LO input power = 13 dBm.

		N × LO					
		0	1	2	3	4	5
M × RF	0	N/A	+8	+21	+32	+55	N/A
	1	-1	0	+18	+44	+36	+54
	2	+57	+65	+65	+63	+75	+83
	3	+76	+82	+64	+65	+71	+85
	4	+80	+85	+89	+89	+96	+91
	5	N/A	+81	+83	+90	+90	+96

RF frequency = 18 GHz and RF input power = -10 dBm.
LO frequency = 18.5 GHz and LO input power = 13 dBm.

		N × LO					
		0	1	2	3	4	5
M × RF	0	N/A	-8	+54	N/A	N/A	N/A
	1	+9	0	+31	+54	N/A	N/A
	2	+80	+55	+58	+67	+79	N/A
	3	N/A	+81	+88	+70	+85	+78
	4	N/A	N/A	+83	+90	+95	+88
	5	N/A	N/A	N/A	+83	+90	+95

RF frequency = 26 GHz and RF input power = -10 dBm.
LO frequency = 26.5 GHz and LO input power = 13 dBm.

		N × LO					
		0	1	2	3	4	5
M × RF	0	N/A	11	N/A	N/A	N/A	N/A
	1	10	0	36	N/A	N/A	N/A
	2	N/A	60	67	71	N/A	N/A
	3	N/A	N/A	82	73	85	N/A
	4	N/A	N/A	N/A	84	96	81
	5	N/A	N/A	N/A	N/A	83	94

M × N Spurious Outputs, IF = 1000 MHz

RF frequency = 9 GHz and RF input power = -10 dBm.
LO frequency = 8 GHz and LO input power = 13 dBm.

		N × LO					
		0	1	2	3	4	5
M × RF	0	N/A	5	23	37	45	N/A
	1	1	0	18	37	37	N/A
	2	57	63	66	62	82	82
	3	76	78	65	63	77	84
	4	80	83	89	88	89	86
	5	N/A	81	85	90	90	90

RF frequency = 18 GHz and RF input power = -10 dBm.
LO frequency = 17 GHz and LO input power = 13 dBm.

		N × LO					
		0	1	2	3	4	5
M × RF	0	N/A	-5	+45	N/A	N/A	N/A
	1	+9	0	+33	+54	N/A	N/A
	2	+78	+58	+59	+73	+78	N/A
	3	N/A	+80	+85	+70	+83	N/A
	4	N/A	N/A	+82	+86	+89	+85
	5	N/A	N/A	N/A	+81	+87	+89

RF frequency = 26 GHz and RF input power = -10 dBm.
LO frequency = 25 GHz and LO input power = 13 dBm.

		N × LO					
		0	1	2	3	4	5
M × RF	0	N/A	11	N/A	N/A	N/A	N/A
	1	10	0	35	N/A	N/A	N/A
	2	N/A	59	65	67	N/A	N/A
	3	N/A	N/A	81	70	80	N/A
	4	N/A	N/A	N/A	84	85	80
	5	N/A	N/A	N/A	N/A	84	89

Upconversion, Upper Sideband

Mixer spurious products are measured in dBc from the RF output power level. N/A means not applicable.

IF frequency = 6 GHz and RF input power = -10 dBm.
 LO frequency = 5.5 GHz and LO input power = 13 dBm.

		N × LO					
		0	1	2	3	4	5
M × IF	-5	+81	+82	+85	+90	+87	+94
	-4	+85	+87	+90	+88	+89	+92
	-3	+68	+64	+55	+58	+63	+59
	-2	+62	+63	+64	+63	+57	+76
	-1	+3	0	+18	+15	+28	+43
	0	N/A	-2	+21	+15	+37	+42
	+1	+3	+3	+35	+36	+40	+58
	+2	+62	+70	+68	+75	+81	+77
	+3	+68	+74	+79	+81	+79	N/A
	+4	+85	+83	+78	+77	N/A	N/A
	+5	+83	+79	+77	N/A	N/A	N/A

Upconversion, Lower Sideband

Mixer spurious products are measured in dBc from the IF output power level. N/A means not applicable.

IF frequency = 6 GHz and RF input power = -10 dBm.
 LO frequency = 6.5 GHz and LO input power = 13 dBm.

		N × LO					
		0	1	2	3	4	5
M × IF	-5	+83	+85	+89	+90	+90	+95
	-4	+86	+89	+92	+90	+94	+91
	-3	+71	+71	+56	+60	+61	+73
	-2	+68	+55	+53	+72	+75	+71
	-1	+5	0	+18	+22	+32	+55
	0	N/A	-1	+20	+20	+39	+50
	+1	+5	+6	+36	+35	+47	+72
	+2	+69	+69	+75	+79	+79	N/A
	+3	+71	+79	+83	+77	N/A	N/A
	+4	+86	+83	+79	N/A	N/A	N/A
	+5	+81	+80	N/A	N/A	N/A	N/A

THEORY OF OPERATION

The HMC773A is a general-purpose, double balanced mixer that can be used as an upconverter or a downconverter from 6 GHz to 26 GHz.

When used as a downconverter, the HMC773A downconverts RF values between 6 GHz and 26 GHz to IF values between dc and 8 GHz.

When used as an upconverter, the mixer upconverts IF values between dc and 8 GHz to RF values between 6 GHz and 26 GHz.

The mixer performs well with LO drives of 13 dBm or greater, and it provides excellent LO to RF and LO to IF suppression due to optimized balun structures.

APPLICATIONS INFORMATION

TYPICAL APPLICATION CIRCUIT

Figure 63 shows the typical application circuit for the HMC773A. The HMC773A is a passive device and does not require any external components. The LO and RF pins are internally

ac-coupled. When IF operation is not required until dc, it is recommended to use an ac-coupled capacitor at the IF port.

ASSEMBLY DIAGRAM

The assembly diagram is shown in Figure 64.

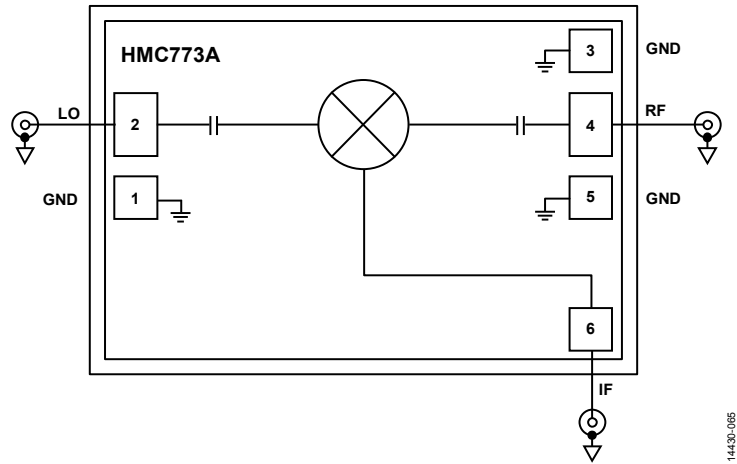

Figure 63. Typical Application Circuit

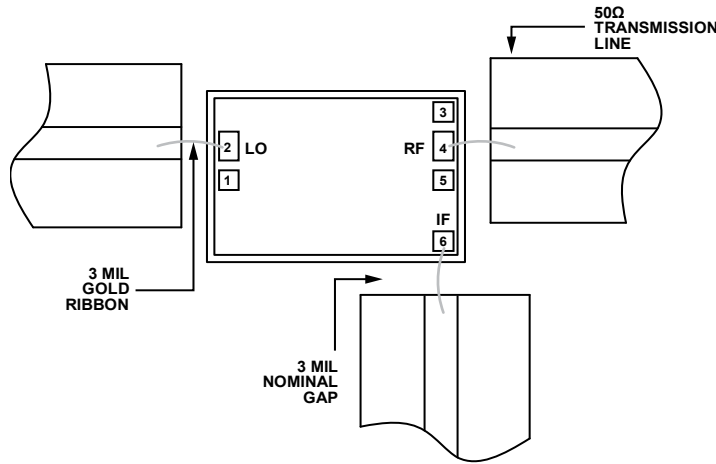

Figure 64. Assembly Diagram

MOUNTING AND BONDING TECHNIQUES FOR MILLIMETER WAVE GAAS MMICS

Attach the die directly to the ground plane eutectically or with conductive epoxy.

To bring RF to and from the chip, use 50 Ω microstrip transmission lines on 0.127 mm (0.005 inches) alumina thin film substrates (see Figure 65).

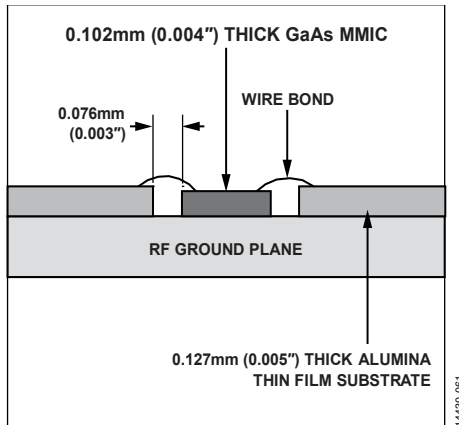

Figure 65. Routing RF Signals

If 0.254 mm (0.010 inches) alumina thin film substrates must be used, raise the die 0.150 mm (0.006 inches) so that the surface of the die is coplanar with the surface of the substrate.

One way to accomplish this coplanarity is to attach the 0.102 mm (0.004 inches) die to a 0.150 mm (0.006 inches) molybdenum heat spreader (moly tab), which is then attached to the ground plane (see Figure 66).

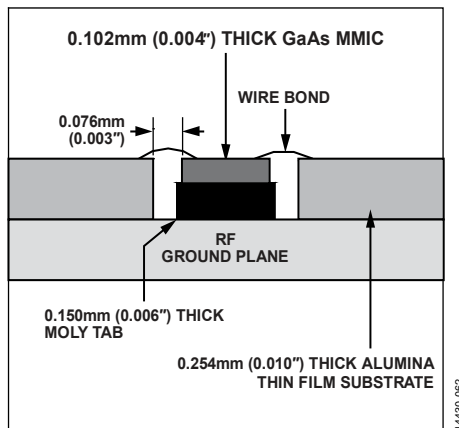

Figure 66. Routing RF Signals (Raised)

Bring the microstrip substrates as close to the die as possible to minimize ribbon bond length. Typical die to substrate spacing is 0.076 mm (0.003 inches). Gold ribbon of a 0.076 mm (0.003 inches) width and a <0.31 mm minimal length (<0.012 inches) is recommended to minimize inductance on the RF, LO, and IF ports.

HANDLING PRECAUTIONS

To avoid permanent damage, adhere to the following precautions.

Storage

All bare die ship in either waffle-based or gel-based ESD protective containers, and are then sealed in an electrostatic discharge (ESD) protective bag. After opening the sealed ESD protective bag, all die must be stored in a dry nitrogen environment.

Cleanliness

Handle the chips in a clean environment. Never use liquid cleaning systems to clean the chip.

Static Sensitivity

Follow ESD precautions to protect against ESD strikes.

Transients

Suppress instrument and bias supply transients while bias is applied. To minimize inductive pickup, use shielded signal and bias cables.

General Handling

Handle the chip only on the edges, using a vacuum collet or with a sharp pair of bent tweezers. Because the surface of the chip has fragile air bridges, never touch the surface of the chip with a vacuum collet, tweezers, or fingers.

MOUNTING

The chip is back metallized and can be die mounted with gold (Au)/tin (Sn) eutectic performs or with electrically conductive epoxy. The mounting surface must be clean and flat.

Eutectic Die Attach

It is best to use an 80% Au/20% Sn preform with a work surface temperature of 255°C and a tool temperature of 265°C. When hot 90% nitrogen/10% hydrogen gas is applied, maintain the tool tip temperature at 290°C. Do not expose the chip to a temperature greater than 320°C for more than 20 sec. No more than 3 sec of scrubbing is required for attachment.

Epoxy Die Attach

Apply a minimum amount of epoxy to the mounting surface so that a thin epoxy fillet is observed around the perimeter of the chip after placing it into position. Cure the epoxy per the schedule provided by the manufacturer.

WIRE BONDING

RF bonds made with 0.003 inch \times 0.005 inch gold ribbon are recommended for the RF ports. These bonds must be thermosonically bonded with a force of 40 g to 60 g. DC bonds of a 0.025 mm (0.001 inches) diameter, thermosonically bonded, are recommended. Create ball bonds with a force of 40 g to 50 g and wedge bonds with a force of 18 g to 22 g. Create all bonds with a nominal stage temperature of 150°C. Apply a minimum amount of ultrasonic energy to achieve reliable bonds. Keep all bonds as short as possible, less than 0.31 mm (0.012 inches).

OUTLINE DIMENSIONS

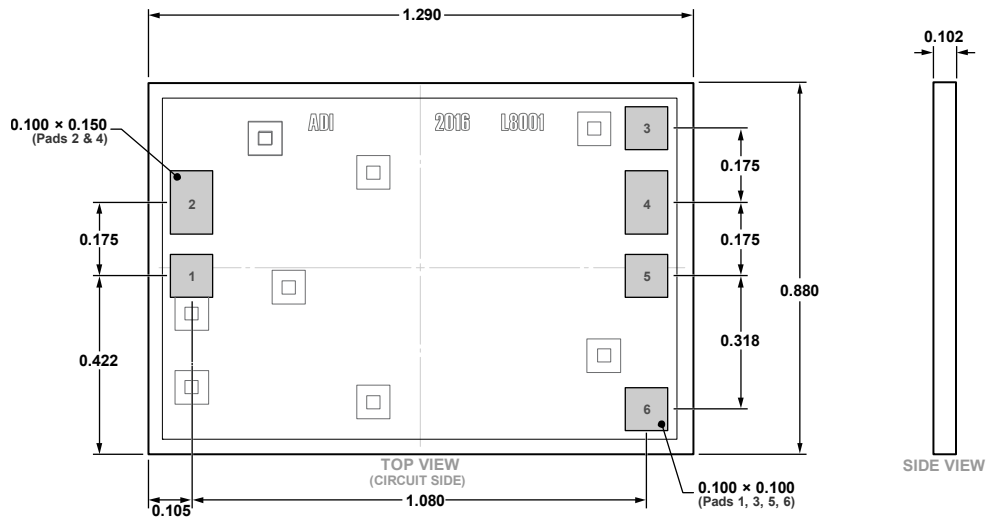

12-19-2017-A

Figure 67. 6-Pad Bare Die [CHIP]
(C-6-12)
Dimensions shown in millimeter

ORDERING GUIDE

Model	Temperature Range	Package Description	Package Option
HMC773A	-55°C to +85°C	6-Pad Bare Die [CHIP]	C-6-12
HMC773A-SX	-55°C to +85°C	6-Pad Bare Die [CHIP]	C-6-12