



Chipsmall Limited consists of a professional team with an average of over 10 year of expertise in the distribution of electronic components. Based in Hongkong, we have already established firm and mutual-benefit business relationships with customers from,Europe,America and south Asia,supplying obsolete and hard-to-find components to meet their specific needs.

With the principle of “Quality Parts,Customers Priority,Honest Operation,and Considerate Service”,our business mainly focus on the distribution of electronic components. Line cards we deal with include Microchip,ALPS,ROHM,Xilinx,Pulse,ON,Everlight and Freescale. Main products comprise IC,Modules,Potentiometer,IC Socket,Relay,Connector.Our parts cover such applications as commercial,industrial, and automotives areas.

We are looking forward to setting up business relationship with you and hope to provide you with the best service and solution. Let us make a better world for our industry!



Contact us

Tel: +86-755-8981 8866 Fax: +86-755-8427 6832

Email & Skype: info@chipsmall.com Web: www.chipsmall.com

Address: A1208, Overseas Decoration Building, #122 Zhenhua RD., Futian, Shenzhen, China





GaAs SMT pHEMT DUAL CHANNEL LOW NOISE AMPLIFIER, 1.7 - 2.2 GHz

Typical Applications

The HMC818LP4E is ideal for:

- Cellular/3G and LTE/WiMAX/4G
- BTS & Infrastructure
- Repeaters and Femtocells
- Public Safety Radios

Features

- Low Noise Figure: 0.85 dB
- High Gain: 20.5 dB
- High OIP3: +35 dBm
- Single Supply: +3V to +5V
- 50 Ohm Matched Input/Output
- 24 Lead 4x4mm QFN Package: 16mm²

Functional Diagram

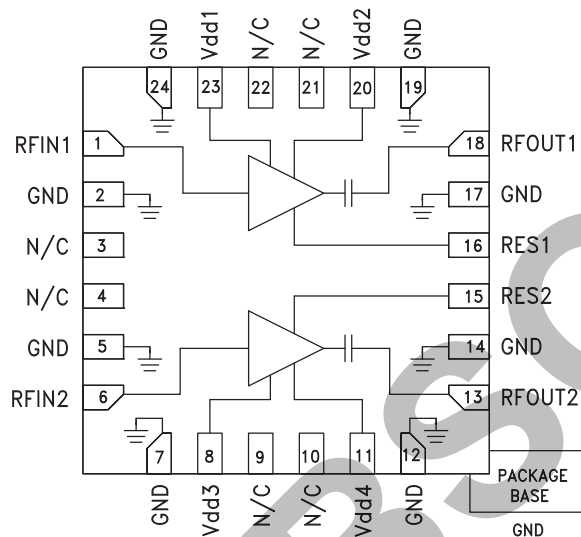

General Description

The HMC818LP4E is a GaAs pHEMT Dual Channel Low Noise Amplifier that is ideal for Cellular/3G and LTE/WiMAX/4G basestation front-end receivers operating between 1.7 - 2.2 GHz. The amplifier has been optimized to provide 0.85 dB noise figure, 20.5 dB gain and +35 dBm output IP3 from a single supply of +5V. Input and output return losses are excellent and the LNA requires minimal external matching and bias decoupling components. The HMC818LP4E can be biased with +3V to +5V and features an externally adjustable supply current which allows the designer to tailor the linearity performance of each channel of the LNA for a specific application.

Electrical Specifications,

$T_A = +25^\circ C$, $R_{bias} = 10K$, $V_{dd} = V_{dd1}, 2, 3, 4$, $I_{dd} = I_{dd1} + I_{dd2}, I_{dd3} + I_{dd4}$

Parameter	Vdd = 3V						Vdd = 5V						Units
	Min.	Typ.	Max.	Min.	Typ.	Max.	Min.	Typ.	Max.	Min.	Typ.	Max.	
Frequency Range	1700 - 2000			2000 - 2200			1700 - 2000			2000 - 2200			MHz
Gain	15	18		14	16.5		17	20.5		15.5	17.5		dB
Gain Variation Over Temperature		0.010			0.008			0.015			0.012		dB/°C
Noise Figure		0.95	1.2		0.95	1.2		0.85	1.1		0.85	1.1	dB
Input Return Loss		18			17			21			18		dB
Output Return Loss		16			15			15			13		dB
Output Power for 1 dB Compression (P1dB)		14			15			19			21		dBm
Saturated Output Power (Psat)		15			16			20			21.5		dBm
Output Third Order Intercept (IP3)		24.5			25			33			35		dBm
Supply Current (Idd)	30	42	55	30	42	55	78	112	146	78	112	146	mA

* Rbias resistor sets current, see application circuit herein



GaAs SMT pHEMT DUAL CHANNEL LOW NOISE AMPLIFIER, 1.7 - 2.2 GHz

Broadband Gain & Return Loss^{[1] [2]}

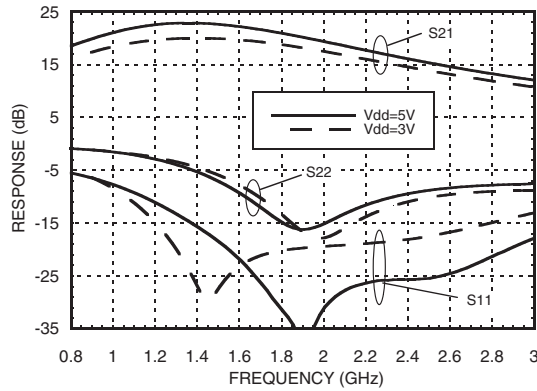

Gain vs. Temperature^[1]

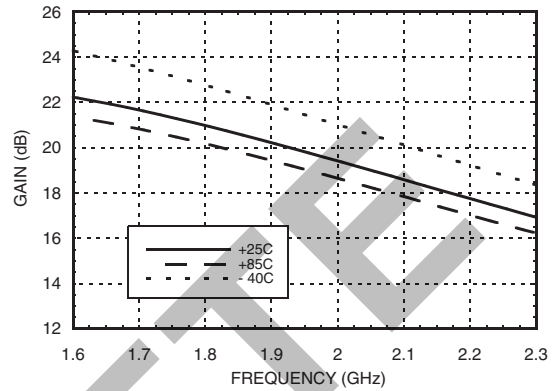

Gain vs. Temperature^[2]

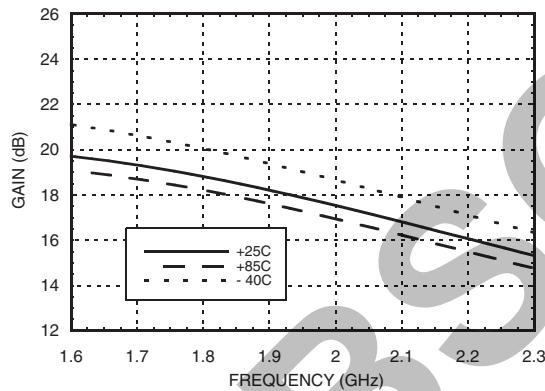

Input Return Loss vs. Temperature^[1]

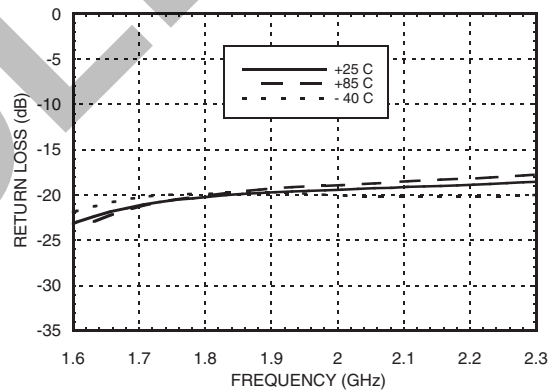

Output Return Loss vs. Temperature^[1]

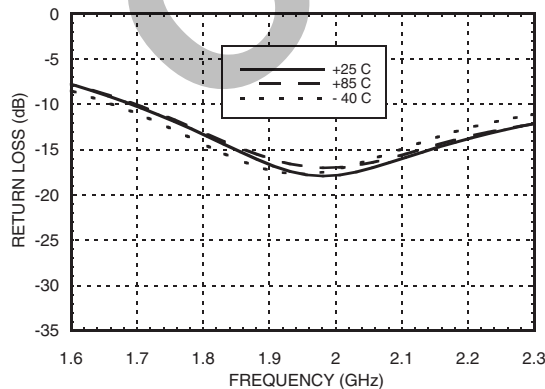

Reverse Isolation vs. Temperature^[1]

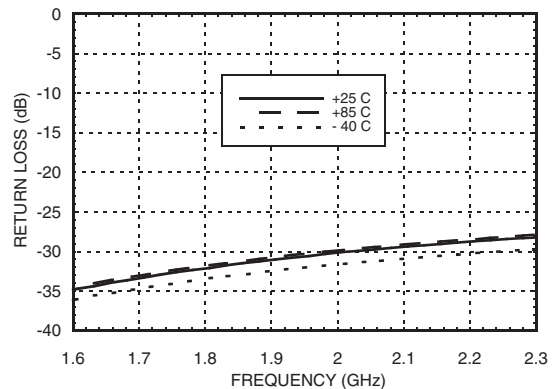

[1] Vdd = 5V, Rbias = 10K [2] Vdd = 3V, Rbias = 10K

Information furnished by Analog Devices is believed to be accurate and reliable. However, no responsibility is assumed by Analog Devices for its use, nor for any infringements of patents or other rights of third parties that may result from its use. Specifications subject to change without notice. No license is granted by implication or otherwise under any patent or patent rights of Analog Devices. Trademarks and registered trademarks are the property of their respective owners.

For price, delivery, and to place orders: Analog Devices, Inc., One Technology Way, P.O. Box 9106, Norwood, MA 02062-9106 Phone: 781-329-4700 • Order online at www.analog.com Application Support: Phone: 1-800-ANALOG-D



GaAs SMT pHEMT DUAL CHANNEL LOW NOISE AMPLIFIER, 1.7 - 2.2 GHz

Noise Figure vs Temperature [1]

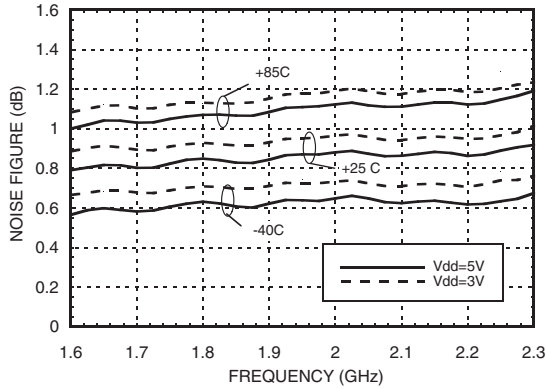

Output P1dB vs. Temperature

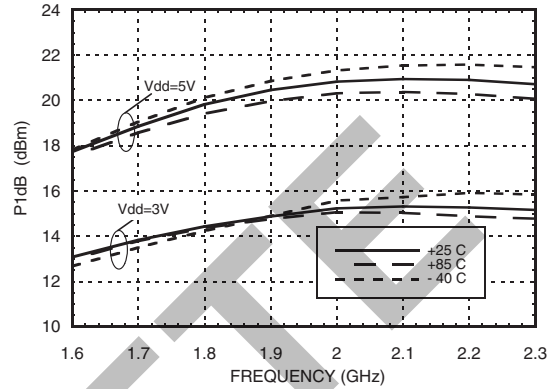

Psat vs. Temperature

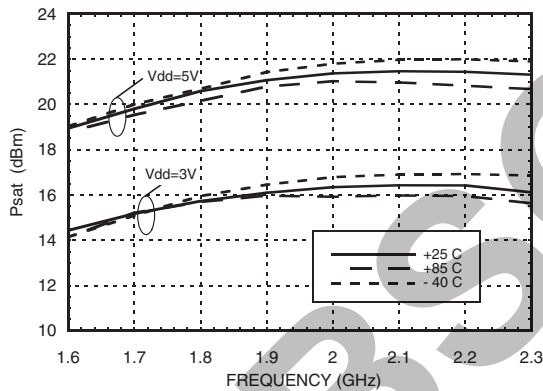

Output IP3 vs. Temperature

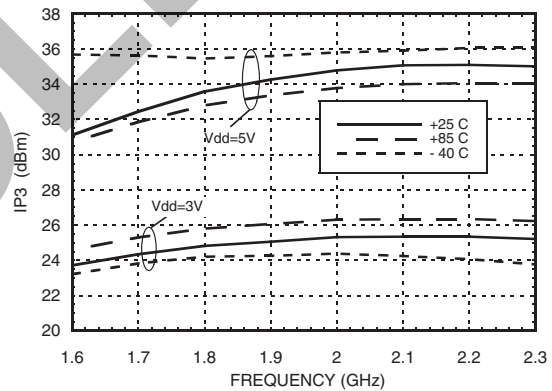

Output IP3 and Idd vs. Supply Voltage @ 1700 MHz

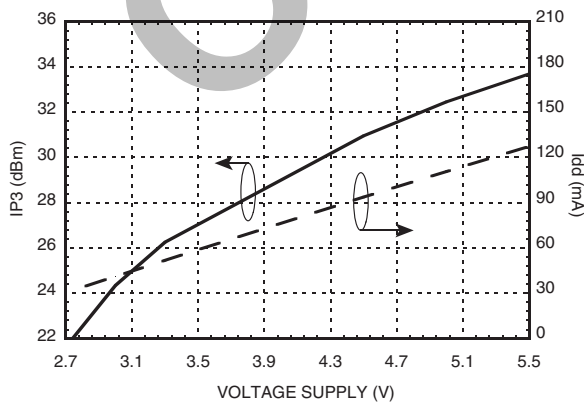

Output IP3 and Idd vs. Supply Voltage @ 2100 MHz

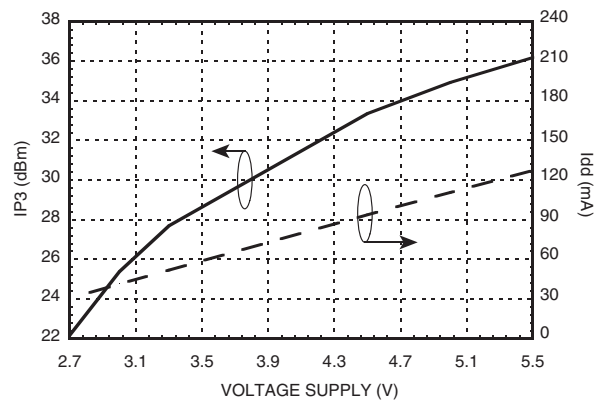

[1] Measurement reference plane shown on evaluation PCB drawing.

Information furnished by Analog Devices is believed to be accurate and reliable. However, no responsibility is assumed by Analog Devices for its use, nor for any infringements of patents or other rights of third parties that may result from its use. Specifications subject to change without notice. No license is granted by implication or otherwise under any patent or patent rights of Analog Devices. Trademarks and registered trademarks are the property of their respective owners.

For price, delivery, and to place orders: Analog Devices, Inc., One Technology Way, P.O. Box 9106, Norwood, MA 02062-9106 Phone: 781-329-4700 • Order online at www.analog.com Application Support: Phone: 1-800-ANALOG-D



GaAs SMT pHEMT DUAL CHANNEL LOW NOISE AMPLIFIER, 1.7 - 2.2 GHz

Power Compression @ 1700 MHz [1]

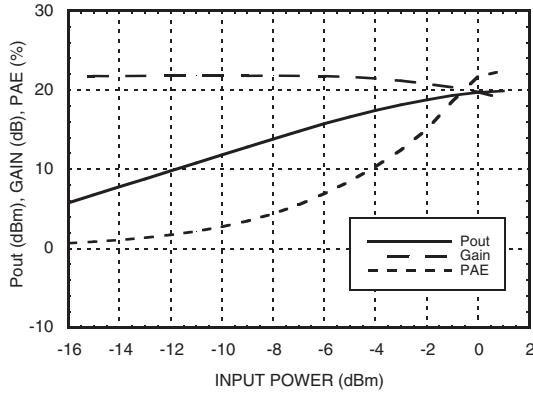

Power Compression @ 1700 MHz [2]

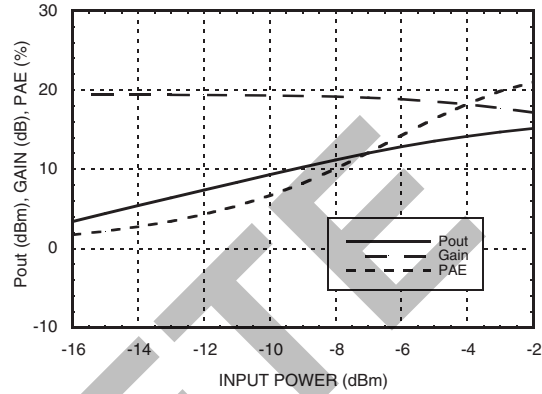

Power Compression @ 2100 MHz [1]

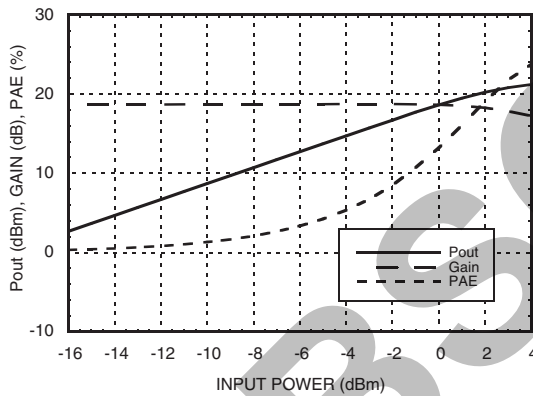

Power Compression @ 2100 MHz [2]

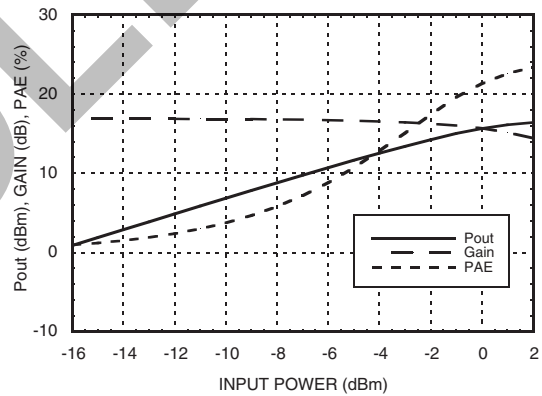

Gain, Power & Noise Figure vs. Supply Voltage @ 1700 MHz

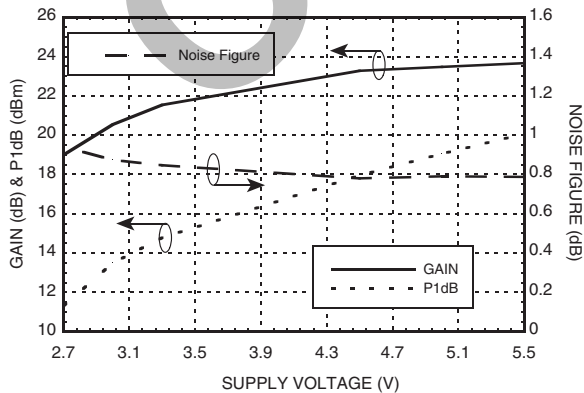

Gain, Power & Noise Figure vs. Supply Voltage @ 2100 MHz

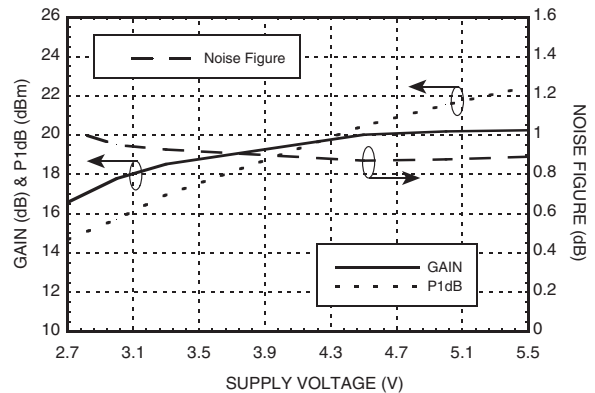

[1] Vdd = 5V [2] Vdd = 3V

Information furnished by Analog Devices is believed to be accurate and reliable. However, no responsibility is assumed by Analog Devices for its use, nor for any infringements of patents or other rights of third parties that may result from its use. Specifications subject to change without notice. No license is granted by implication or otherwise under any patent or patent rights of Analog Devices. Trademarks and registered trademarks are the property of their respective owners.

For price, delivery, and to place orders: Analog Devices, Inc., One Technology Way, P.O. Box 9106, Norwood, MA 02062-9106 Phone: 781-329-4700 • Order online at www.analog.com Application Support: Phone: 1-800-ANALOG-D



GaAs SMT pHEMT DUAL CHANNEL LOW NOISE AMPLIFIER, 1.7 - 2.2 GHz

7

AMPLIFIERS - LOW NOISE - SMT

Output IP3 vs. Rbias @ 1700 MHz [1]

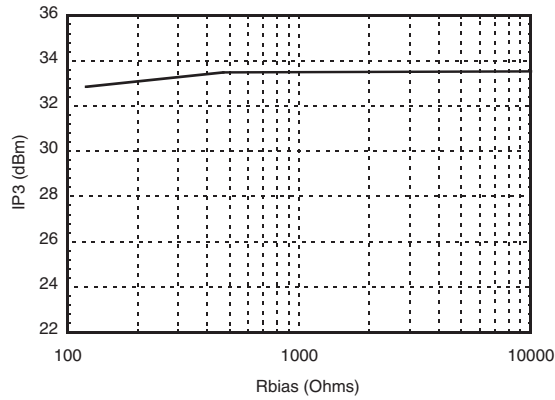

Gain, Noise Figure & Rbias @ 1700 MHz [1]

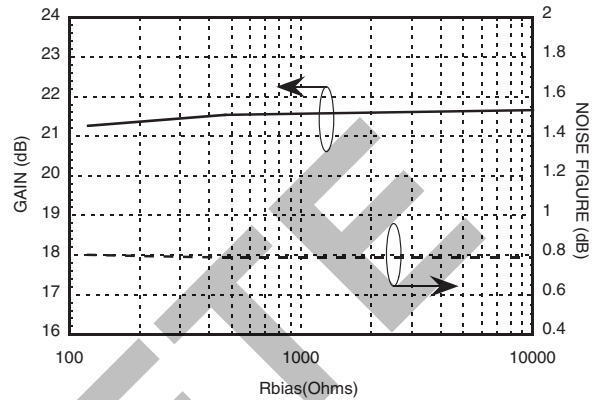

Output IP3 vs. Rbias @ 2100 MHz [1]

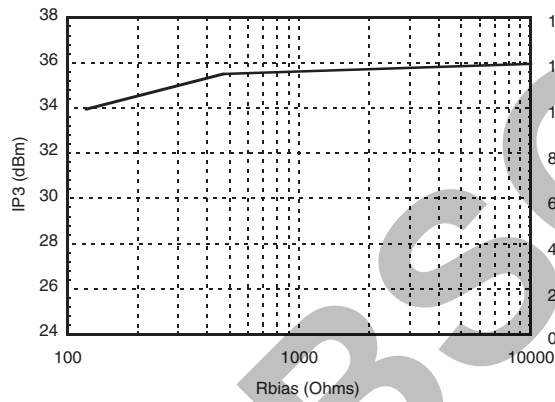

Gain, Noise Figure & Rbias @ 2100 MHz [1]

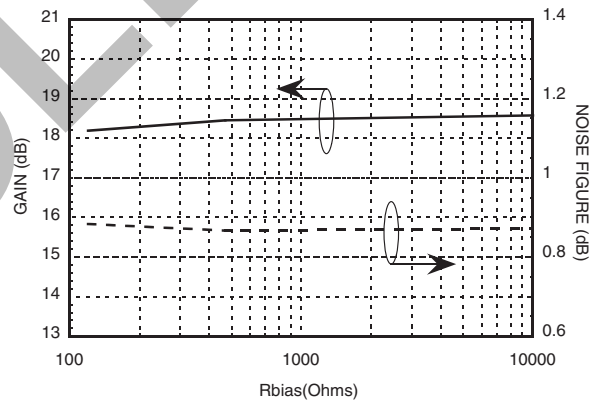

Cross Channel Isolation [1]

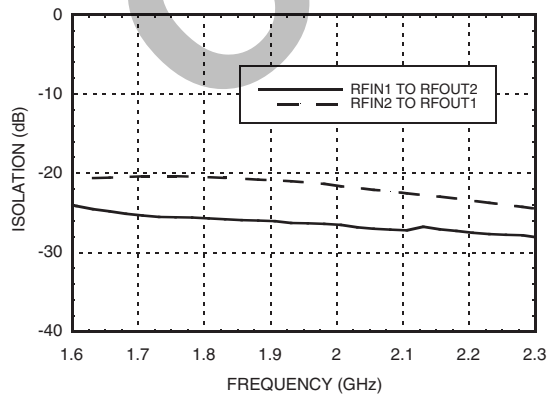

Magnitude Balance [1]

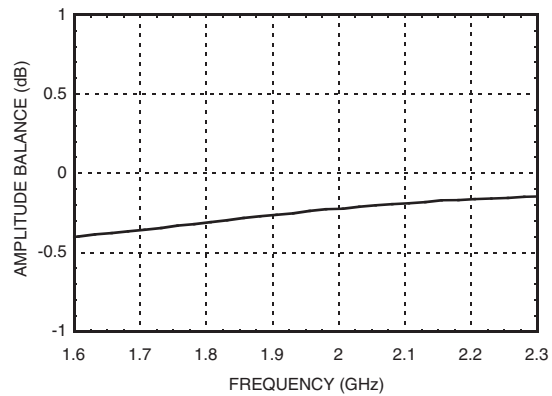

[1] Vdd = 5V

Information furnished by Analog Devices is believed to be accurate and reliable. However, no responsibility is assumed by Analog Devices for its use, nor for any infringements of patents or other rights of third parties that may result from its use. Specifications subject to change without notice. No license is granted by implication or otherwise under any patent or patent rights of Analog Devices. Trademarks and registered trademarks are the property of their respective owners.

For price, delivery, and to place orders: Analog Devices, Inc., One Technology Way, P.O. Box 9106, Norwood, MA 02062-9106 Phone: 781-329-4700 • Order online at www.analog.com Application Support: Phone: 1-800-ANALOG-D

GaAs SMT pHEMT DUAL CHANNEL LOW NOISE AMPLIFIER, 1.7 - 2.2 GHz



Phase Balance [1]

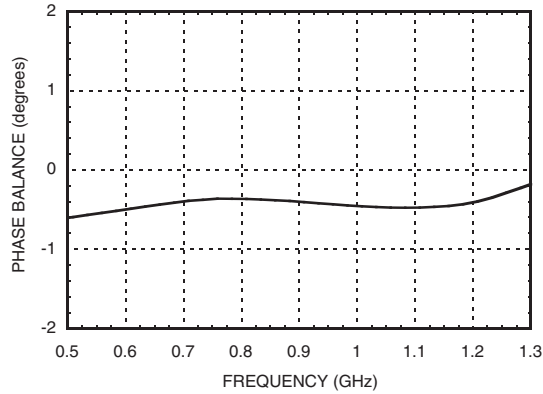

Absolute Bias Resistor

Range & Recommended Bias Resistor Values for I_{dd}

V _{dd} (V)	R _{bias}			I _{dd} (mA)
	Min (Ohms)	Max (Ohms)	R1 (Ohms)	
3V	10K [2]	Open Circuit	10K	42
5V	0	Open Circuit	120	64
			470	82
			10K	112

[2] With V_{dd}= 3V and R_{bias} < 10K Ohm may result in the part becoming conditionally unstable which is not recommended.

Absolute Maximum Ratings

Drain Bias Voltage (V _{dd})	6V
RF Input Power (RFIN) (V _{dd} = +5 V _{dc})	+10 dBm
Channel Temperature	150 °C
Continuous P _{diss} (T= 85 °C) (derate 19.35 mW/°C above 85 °C)	1.26 W
Thermal Resistance (channel to ground paddle)	51.67 °C/W
Storage Temperature	-65 to +150 °C
Operating Temperature	-40 to +85 °C

Typical Supply

Current vs. V_{dd} (R_{bias} = 10K)

V _{dd} (V)	I _{dd} (mA)
2.7	31
3.0	42
3.3	52
4.5	95
5.0	112
5.5	129

Note: Amplifier will operate over full voltage ranges shown above.



**ELECTROSTATIC SENSITIVE DEVICE
OBSERVE HANDLING PRECAUTIONS**

[1] V_{dd} = 5V



**GaAs SMT pHEMT DUAL CHANNEL
LOW NOISE AMPLIFIER, 1.7 - 2.2 GHz**

7

AMPLIFIERS - LOW NOISE - SMT

Outline Drawing

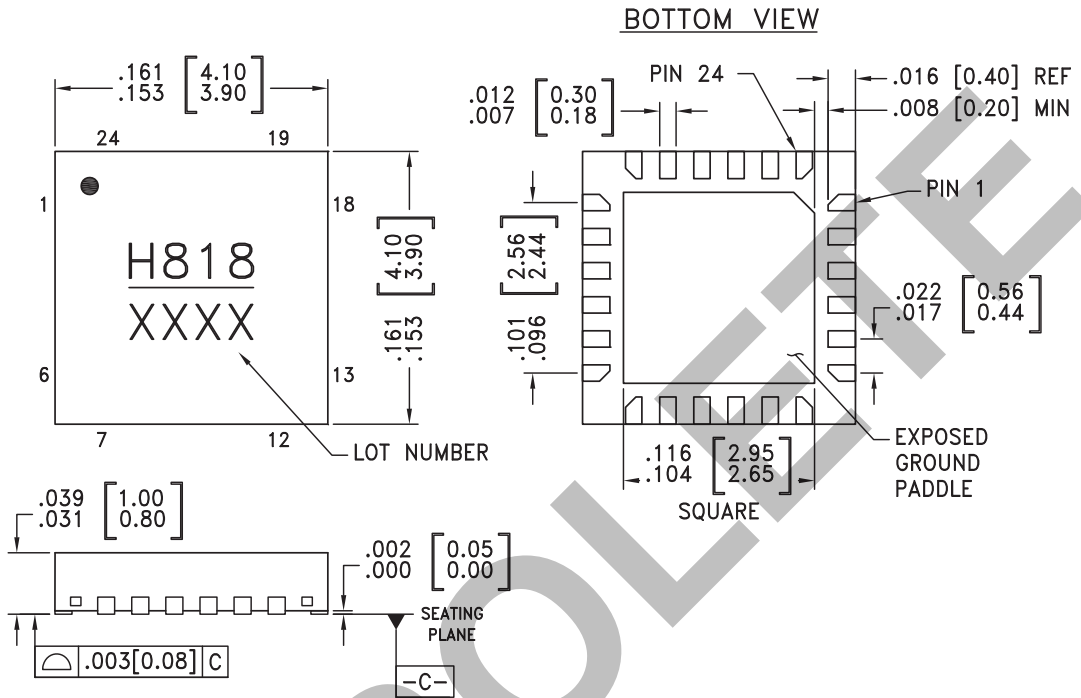

Package Information

Part Number	Package Body Material	Lead Finish	MSL Rating	Package Marking ^[1]
HMC818LP4E	RoHS-compliant Low Stress Injection Molded Plastic	100% matte Sn	MSL1 ^[2]	818 XXXX

[1] 4-Digit lot number XXXX

[2] Max peak reflow temperature of 235 °C

GaAs SMT pHEMT DUAL CHANNEL LOW NOISE AMPLIFIER, 1.7 - 2.2 GHz



Pin Descriptions

Pin Number	Function	Description	Interface Schematic
1, 6	RFIN1, 2	This pin is DC coupled an off chip DC blocking capacitor is required.	RFIN1,2
2, 5, 7, 12, 14, 17, 19, 24	GND	Package bottom must be connected to RF/DC ground.	
3, 4, 9, 10, 21, 22	N/C	No connection required. These pins may be connected to RF/DC ground without affecting performance.	
23, 20, 8, 11	Vdd1, 2, 3, 4	Power supply voltage for each amplifier. Choke inductor and bypass capacitors are required. See application circuit.	
18, 13	RFOUT1, 2	This pin is matched to 50 Ohms.	
16, 15	RES1, 2	These pins are used to set the DC current Idd2 and Idd4 in each amplifier via an external biasing resistor. See application circuit.	



**GaAs SMT pHEMT DUAL CHANNEL
LOW NOISE AMPLIFIER, 1.7 - 2.2 GHz**

7

Application Circuit

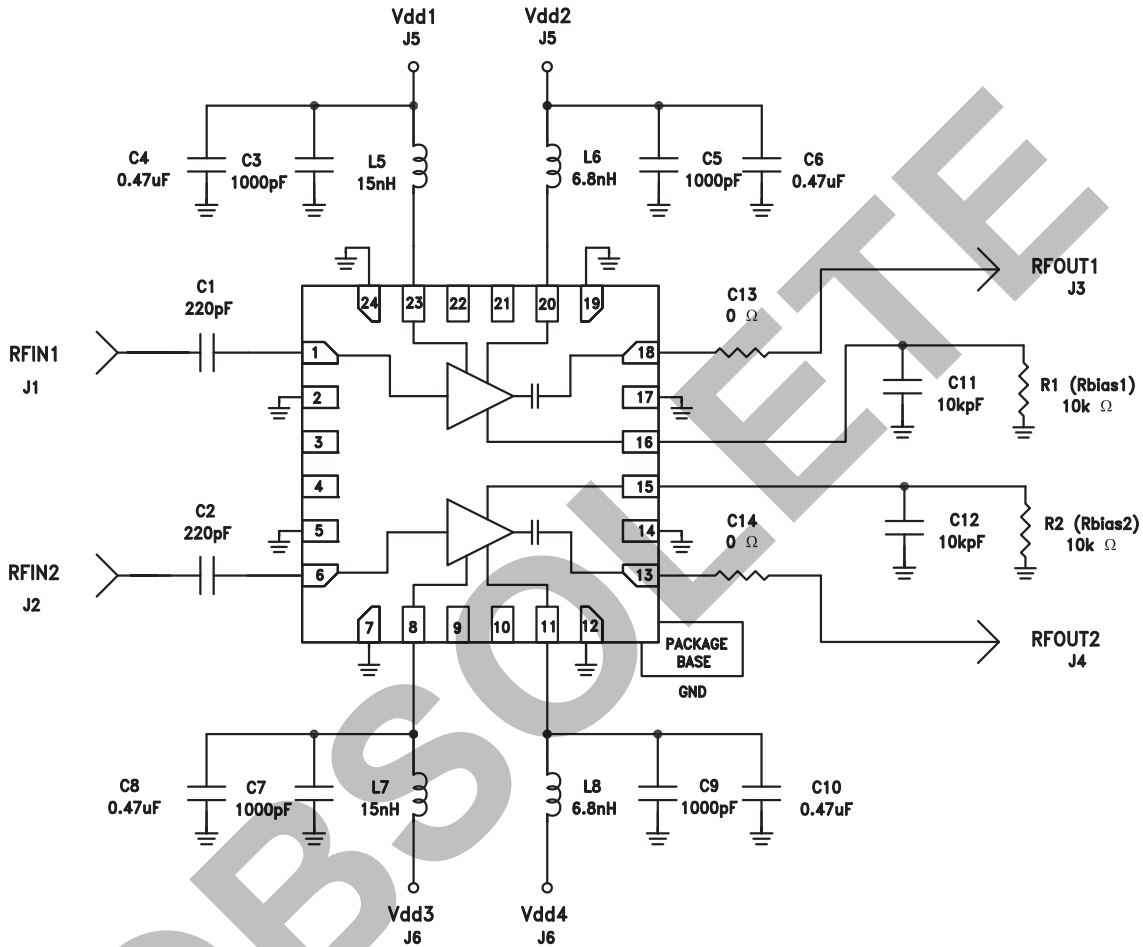

Information furnished by Analog Devices is believed to be accurate and reliable. However, no responsibility is assumed by Analog Devices for its use, nor for any infringements of patents or other rights of third parties that may result from its use. Specifications subject to change without notice. No license is granted by implication or otherwise under any patent or patent rights of Analog Devices. Trademarks and registered trademarks are the property of their respective owners.

For price, delivery, and to place orders: Analog Devices, Inc., One Technology Way, P.O. Box 9106, Norwood, MA 02062-9106 Phone: 781-329-4700 • Order online at www.analog.com Application Support: Phone: 1-800-ANALOG-D

GaAs SMT pHEMT DUAL CHANNEL LOW NOISE AMPLIFIER, 1.7 - 2.2 GHz



Evaluation PCB

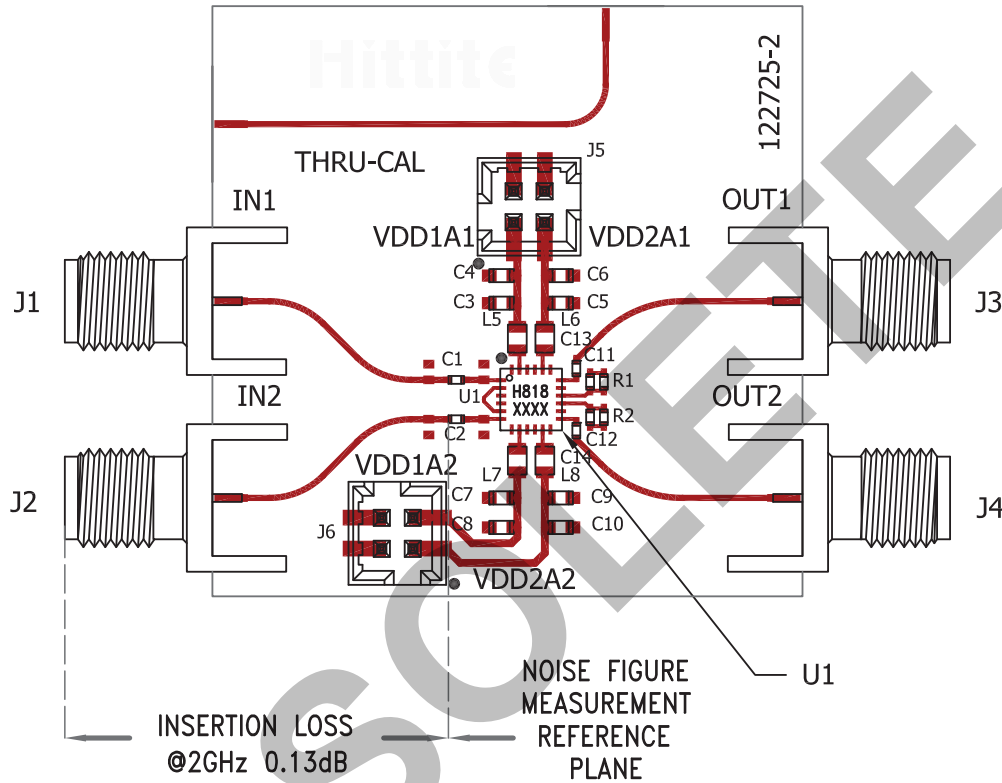

List of Materials for Evaluation PCB 122727 [1]

Item	Description
J1 - J4	PCB Mount SMA RF Connector
J5, J6	2mm Vertical Molex 8pos Connector
C1, C2	220 pF Capacitor, 0402 Pkg..
C3, C5, C7, C9	1000 pF Capacitor, 0603 Pkg.
C4, C6, C8, C10	0.47 μ F Capacitor, 0603 Pkg.
C11, C12	10 kpF Capacitor, 0402 Pkg.
C13, C14	0 Ohm Resistor, 0402 Pkg.
L5, L7	15 nH Inductor, 0603 Pkg.
L6, L8	6.8 nH Inductor, 0603 Pkg.
R1, R2 (Rbias 1, 2)	10k Ohm Resistor, 0402 Pkg.
U1	HMC818LP4(E) Amplifier
PCB [2]	122725 Evaluation PCB

[1] Reference this number when ordering complete evaluation PCB

[2] Circuit Board Material: Rogers 4350 or Arlon 25FR

The circuit board used in this application should use RF circuit design techniques. Signal lines should have 50 Ohm impedance while the package ground leads and exposed paddle should be connected directly to the ground plane similar to that shown. A sufficient number of via holes should be used to connect the top and bottom ground planes. The evaluation board should be mounted to an appropriate heat sink. The evaluation circuit board shown is available from Hittite upon request.