



Chipsmall Limited consists of a professional team with an average of over 10 year of expertise in the distribution of electronic components. Based in Hongkong, we have already established firm and mutual-benefit business relationships with customers from,Europe,America and south Asia,supplying obsolete and hard-to-find components to meet their specific needs.

With the principle of "Quality Parts,Customers Priority,Honest Operation,and Considerate Service",our business mainly focus on the distribution of electronic components. Line cards we deal with include Microchip,ALPS,ROHM,Xilinx,Pulse,ON,Everlight and Freescale. Main products comprise IC,Modules,Potentiometer,IC Socket,Relay,Connector.Our parts cover such applications as commercial,industrial, and automotives areas.

We are looking forward to setting up business relationship with you and hope to provide you with the best service and solution. Let us make a better world for our industry!



## Contact us

Tel: +86-755-8981 8866 Fax: +86-755-8427 6832

Email & Skype: info@chipsmall.com Web: www.chipsmall.com

Address: A1208, Overseas Decoration Building, #122 Zhenhua RD., Futian, Shenzhen, China



### FEATURES

- Passive I/Q mixer
- RF and LO range: 2.5 GHz to 8.5 GHz
- Wide IF range: dc to 4 GHz
- Single-ended RF, LO, and IF
- Conversion loss (downconverter): 9 dB (typical)
- Image rejection (downconverter): 25 dBc (typical)
- SSB noise figure (downconverter): 11.5 dB (typical)
- Input IP3 (downconverter): 20 dBm (typical)
- Input P1dB compression point (downconverter): 13 dBm (typical)
- Input IP2 (downconverter): 58 dBm (typical)
- RF to IF isolation (downconverter): 22 dB (typical)
- LO to RF isolation (downconverter): 48 dB (typical)
- LO to IF isolation (downconverter): 38 dB (typical)
- Amplitude balance (downconverter):  $\pm 0.5$  dB (typical)
- Phase balance (downconverter):  $\pm 5^\circ$  (typical)
- RF return loss: 13 dB (typical)
- LO return loss 13 dB (typical)
- IF return loss: 17 dB (typical)
- Exposed pad, 4 mm  $\times$  4 mm, 24-terminal, ceramic LCC package

### APPLICATIONS

- Test and measurement instrumentation
- Military, aerospace, and radar
- Direct conversion receivers

### GENERAL DESCRIPTION

The HMC8193 is a passive, in phase/quadrature (I/Q), monolithic microwave integrated circuit (MMIC) mixer that can be used either as an image rejection mixer for receiver operations, or as a single-sideband upconverter for transmitter operations from 2.5 GHz to 8.5 GHz. The inherent I/Q architecture of the HMC8193 offers excellent image rejection and thereby eliminates the need for expensive filtering of unwanted sidebands. The mixer also provides excellent local oscillator (LO) to radio frequency (RF) and LO to intermediate frequency (IF) isolation and reduces the effect of LO leakage to ensure signal integrity.

### FUNCTIONAL BLOCK DIAGRAM

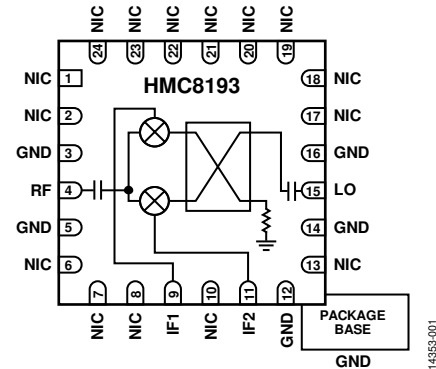

Figure 1.

Being the HMC8193 is a passive mixer, it does not require any dc power sources. The device offers a lower noise figure than an active mixer, ensuring superior dynamic range for high performance and precision applications.

The HMC8193 is fabricated on a gallium arsenide (GaAs), metal semiconductor field effect transistor (MESFET) process and uses Analog Devices, Inc., mixer cells and a 90° hybrid. It is available in a compact, 4 mm  $\times$  4 mm, 24-lead LCC package and operates over the  $-40^\circ\text{C}$  to  $+85^\circ\text{C}$  temperature range. An evaluation board for this device is also available.

## TABLE OF CONTENTS

Features .....	1	Upconverter Performance.....	18
Applications.....	1	Isolation and Return Loss .....	24
Functional Block Diagram .....	1	IF Bandwidth .....	26
General Description .....	1	Amplitude and Phase Imbalance .....	27
Revision History .....	2	Spurious and Harmonics Performance .....	29
Specifications.....	3	Theory of Operation .....	32
Absolute Maximum Ratings.....	4	Applications Information .....	33
Thermal Resistance .....	4	Soldering Information and Recommended Land Pattern ....	34
ESD Caution.....	4	Evaluation Board Information.....	35
Pin Configuration and Function Descriptions.....	5	Outline Dimensions .....	36
Interface Schematics.....	5	Ordering Guide .....	36
Typical Performance Characteristics .....	6		
Downconverter Performance.....	6		

## REVISION HISTORY

### 5/2018—Rev. A to Rev. B

Changes to Applications Information Section.....	33
--	----

### 1/2018—Rev. 0 to Rev. A

Changes to Features.....	1
Changed Single-Sideband (SSB) Noise Figure Parameter from 15 dB Typical to 11.5 dB Typical, Table 1 .....	3
Changes to Ordering Guide .....	36

### 8/2017—Revision 0: Initial Version

## SPECIFICATIONS

T<sub>A</sub> = 25°C, IF = 100 MHz, and LO drive = 18 dBm; all measurements performed as downconverter with lower sideband selected, unless otherwise noted.

Table 1.

Parameter	Symbol	Min	Typ	Max	Unit
RADIO FREQUENCY	RF	2.5		8.5	GHz
LOCAL OSCILLATOR	LO				
Frequency		2.5		8.5	GHz
Drive Level			18		dBm
INTERMEDIATE FREQUENCY	IF	DC		4	GHz
RF PERFORMANCE AS DOWNCONVERTER					
Conversion Loss			9	11	dB
Image Rejection		23	25		dBc
Single-Sideband (SSB) Noise Figure			11.5		dB
Input Third-Order Intercept	IP3	16	20		dBm
Input 1 dB Compression Point	P1dB		13		dBm
Input Second-Order Intercept	IP2		58		dBm
Isolation					
RF to IF		13	22		dB
LO to RF		37	48		dB
LO to IF		30	38		dB
Amplitude Balance			±0.5		dB
Phase Balance			±5		Degrees
RF PERFORMANCE AS UPCONVERTER					
Conversion Loss			8.5		dB
Sideband Rejection			23		dBc
Input Third-Order Intercept	IP3		21		dBm
RETURN LOSS PERFORMANCE					
RF			13		dB
LO			13		dB
IFx			17		dB

## ABSOLUTE MAXIMUM RATINGS

Table 2.

Parameter	Rating
RF Input Power	21 dBm
LO Input Power	25 dBm
IF Input Power	21 dBm
IF Source/Sink Current	6 mA
Continuous Power Dissipation, $P_{DISS}$ ( $T_A = 85^\circ\text{C}$ , Derate 12.44 mW/ $^\circ\text{C}$ Above $85^\circ\text{C}$ )	1120 mW
Maximum Junction Temperature	$175^\circ\text{C}$
Maximum Peak Reflow Temperature (MSL3)	$260^\circ\text{C}$
Operating Temperature Range	$-40^\circ\text{C}$ to $+85^\circ\text{C}$
Storage Temperature Range	$-65^\circ\text{C}$ to $+150^\circ\text{C}$
Electrostatic Discharge (ESD) Sensitivity	
Human Body Model (HBM)	2000 V
Field Induced Charged Device Model (FICDM)	1250 V

Stresses at or above those listed under Absolute Maximum Ratings may cause permanent damage to the product. This is a stress rating only; functional operation of the product at these or any other conditions above those indicated in the operational section of this specification is not implied. Operation beyond the maximum operating conditions for extended periods may affect product reliability.

## THERMAL RESISTANCE

Thermal performance is directly linked to printed circuit board (PCB) design and operating environment. Careful attention to PCB thermal design is required.

Table 3. Thermal Resistance

Package Type	$\theta_{JA}$	$\theta_{JC}$	Unit
E-24-1 <sup>1</sup>	120	80	$^\circ\text{C}/\text{W}$

<sup>1</sup> Thermal impedance simulated values are based on a JEDEC 252P test board with  $4 \times 4$  thermal vias. See JEDEC JESD51-12 for additional information.

## ESD CAUTION



**ESD (electrostatic discharge) sensitive device.** Charged devices and circuit boards can discharge without detection. Although this product features patented or proprietary protection circuitry, damage may occur on devices subjected to high energy ESD. Therefore, proper ESD precautions should be taken to avoid performance degradation or loss of functionality.

# PIN CONFIGURATION AND FUNCTION DESCRIPTIONS

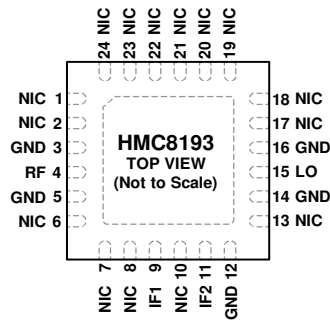

- NOTES**
1. NOT INTERNALLY CONNECTED. NO CONNECTION IS REQUIRED. THESE PINS CAN BE CONNECTED TO RF/DC GROUND WITHOUT AFFECTING PERFORMANCE.
  2. EXPOSED PAD. THE EXPOSED PAD MUST BE CONNECTED TO RF/DC GROUND.

14353-002

Figure 2. Pin Configuration

Table 4. Pin Function Descriptions

Pin No.	Mnemonic	Description
1, 2, 6 to 8, 10, 13, 17 to 24	NIC	Not Internally Connected. No connection is required. These pins can be connected to RF/dc ground without affecting performance.
3, 5, 12, 14, 16	GND	Ground Connect. These pins and package bottom must be connected to RF/dc ground. See Figure 3 for the interface schematic.
4	RF	Radio Frequency. This pin is ac-coupled and matched to 50 Ω. See Figure 5 for the interface schematic.
9	IF1	First and Quadrature Intermediate Frequency. This pin is dc-coupled. For applications not requiring operation to dc, dc block this port externally using a series capacitor with a value selected to pass the necessary IF frequency range. For operation to dc, this pin must not source or sink more than 6 mA of current; otherwise, the device does not function and may fail. See Figure 4 for the interface schematic.
11	IF2	Second Quadrature Intermediate Frequency. This pin is dc-coupled. For applications not requiring operation to dc, dc block this port externally using a series capacitor with a value selected to pass the necessary IF frequency range. For operation to dc, this pin must not source or sink more than 6 mA of current; otherwise, the device does not function and may fail. See Figure 4 for the interface schematic.
15	LO	Local Oscillator. This pin is ac-coupled and matched to 50 Ω. See Figure 6 for the interface schematic.
	EPAD	Exposed Pad. The exposed pad must be connected to RF/dc ground.

## INTERFACE SCHEMATICS



Figure 3. GND Interface Schematic

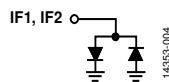

Figure 4. IF1, IF2 Interface Schematic

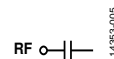

Figure 5. RF Interface Schematic

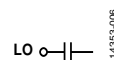

Figure 6. LO Interface Schematic

# TYPICAL PERFORMANCE CHARACTERISTICS

## DOWNCONVERTER PERFORMANCE

### Downconverter Performance at IF = 100 MHz, Lower Sideband

Data taken at LO drive = 18 dBm and TA = 25°C, unless otherwise noted.

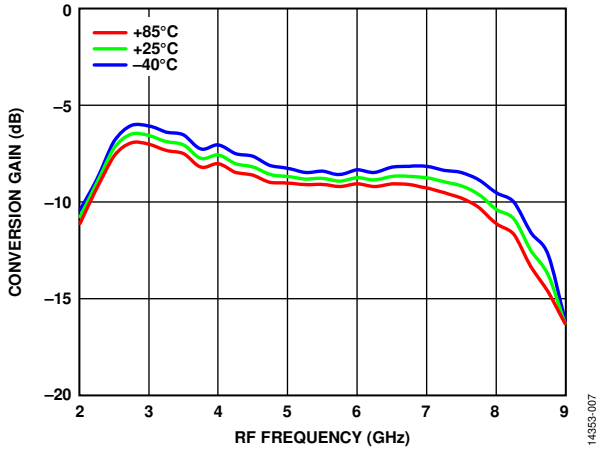

Figure 7. Conversion Gain vs. RF Frequency at Various Temperatures

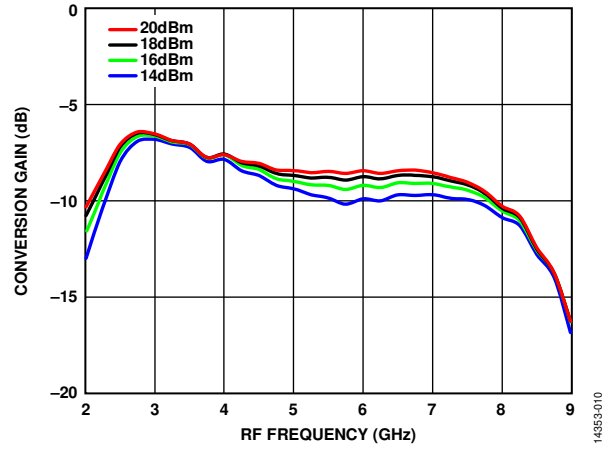

Figure 10. Conversion Gain vs. RF Frequency at Various LO Drives

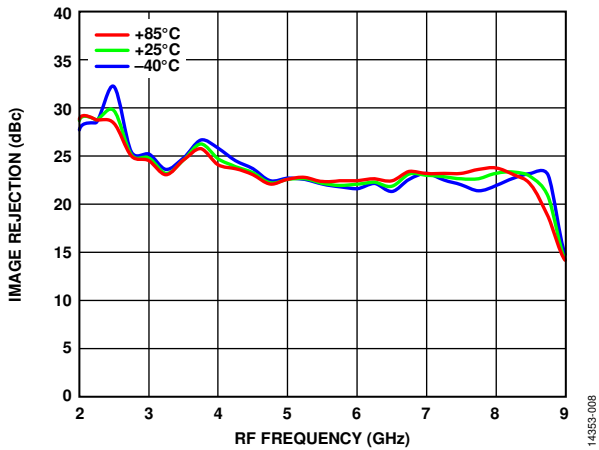

Figure 8. Image Rejection vs. RF Frequency at Various Temperatures

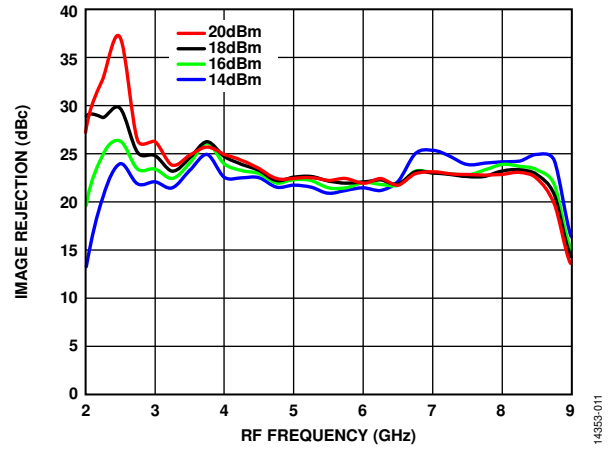

Figure 11. Image Rejection vs. RF Frequency at Various LO Drives

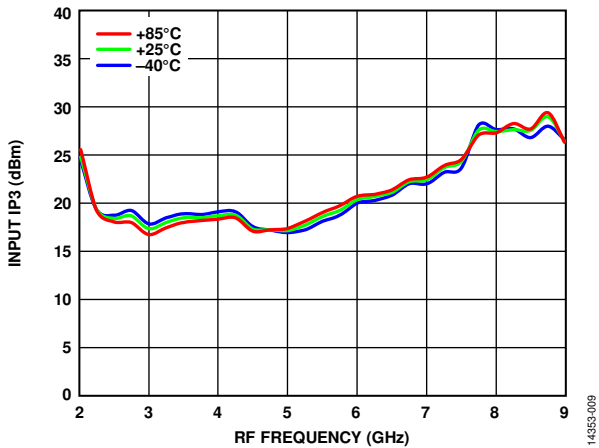

Figure 9. Input IP3 vs. RF Frequency at Various Temperatures

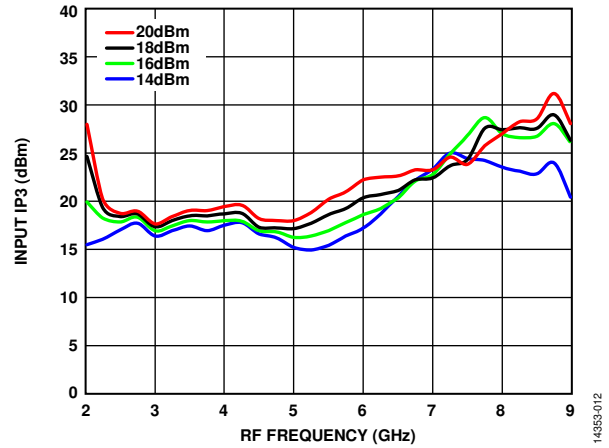

Figure 12. Input IP3 vs. RF Frequency at Various LO Drives

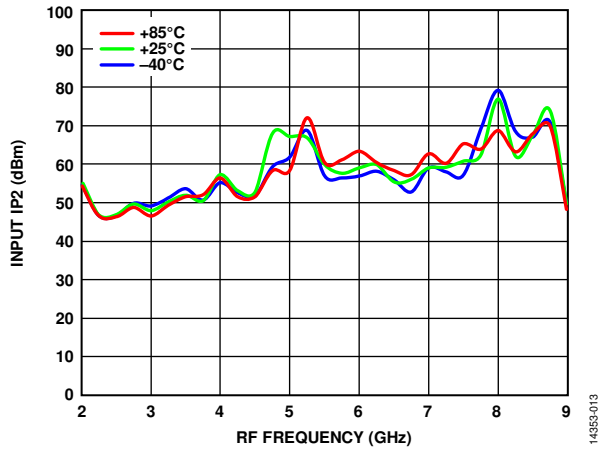

Figure 13. Input IP2 vs. RF Frequency at Various Temperatures

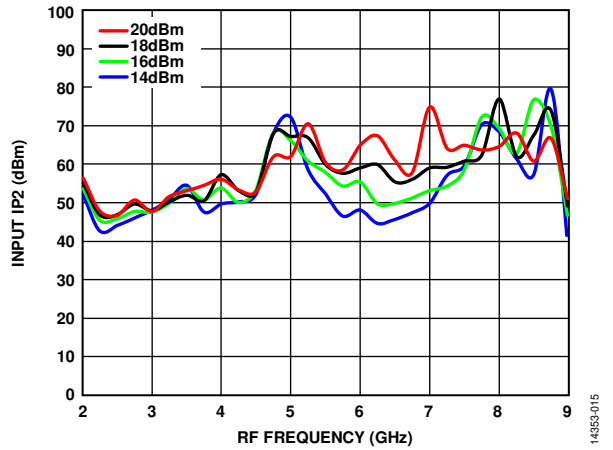

Figure 15. Input IP2 vs. RF Frequency at Various LO Drives

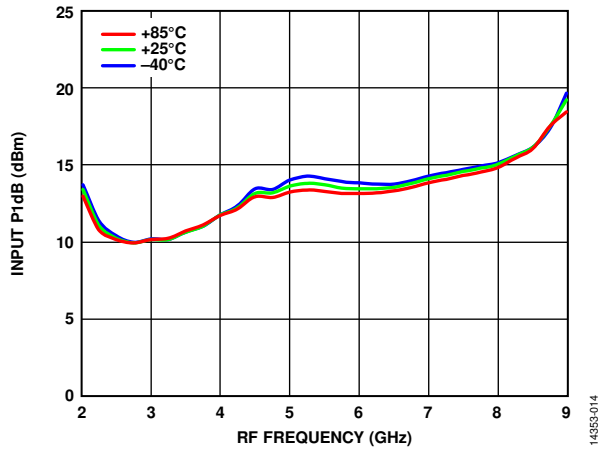

Figure 14. Input P1dB vs. RF Frequency at Various Temperatures

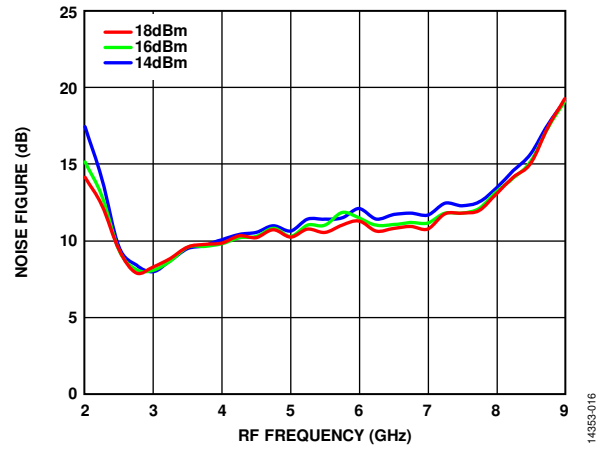

Figure 16. Noise Figure vs. RF Frequency at Various LO Drives



**Downconverter Performance at IF = 1000 MHz, Lower Sideband**

Data taken at LO drive = 18 dBm and T<sub>A</sub> = 25°C, unless otherwise noted.

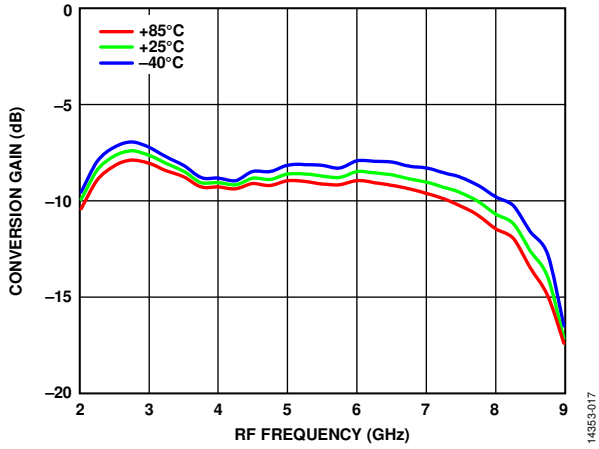

Figure 17. Conversion Gain vs. RF Frequency at Various Temperatures

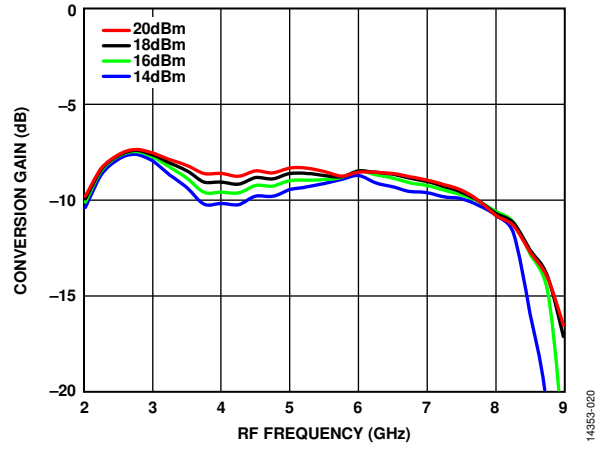

Figure 20. Conversion Gain vs. RF Frequency at Various LO Drives

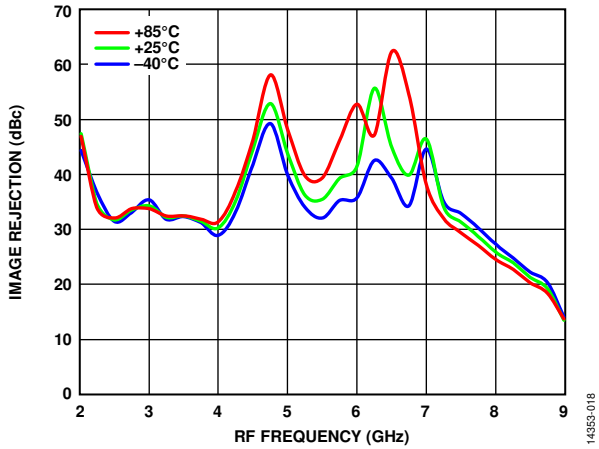

Figure 18. Image Rejection vs. RF Frequency at Various Temperatures

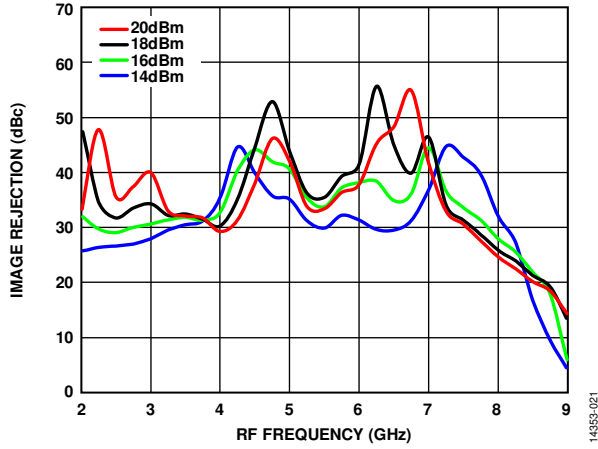

Figure 21. Image Rejection vs. RF Frequency at Various LO Drives

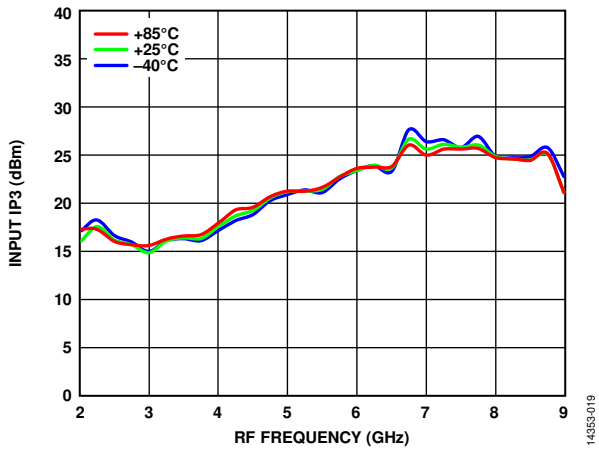

Figure 19. Input IP3 vs. RF Frequency at Various Temperatures

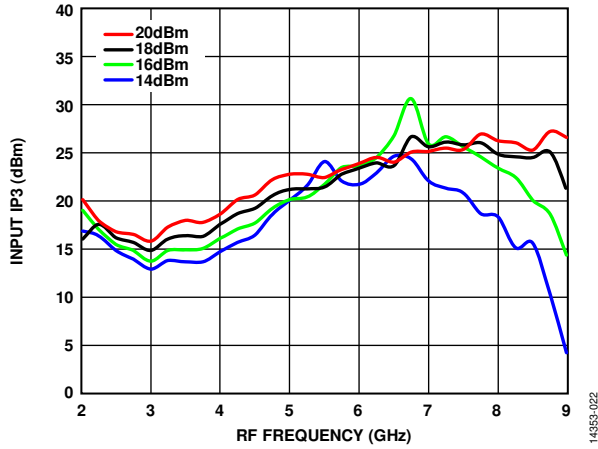

Figure 22. Input IP3 vs. RF Frequency at Various LO Drives

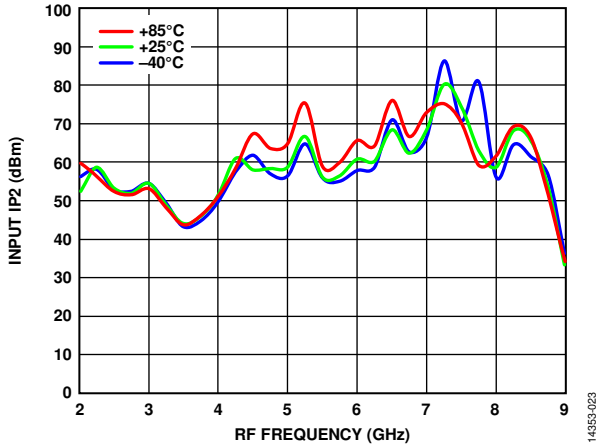

Figure 23. Input IP2 vs. RF Frequency at Various Temperatures

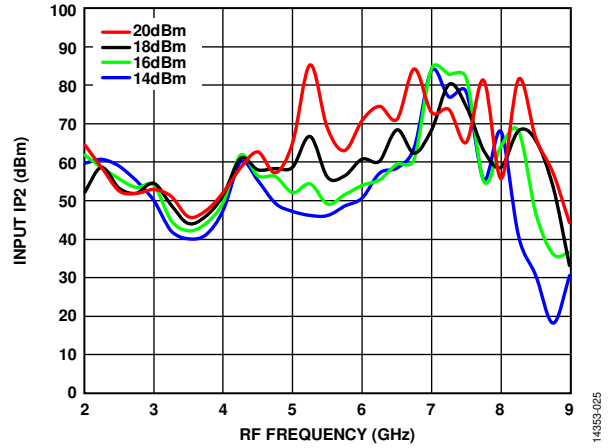

Figure 25. Input IP2 vs. RF Frequency at Various LO Drives

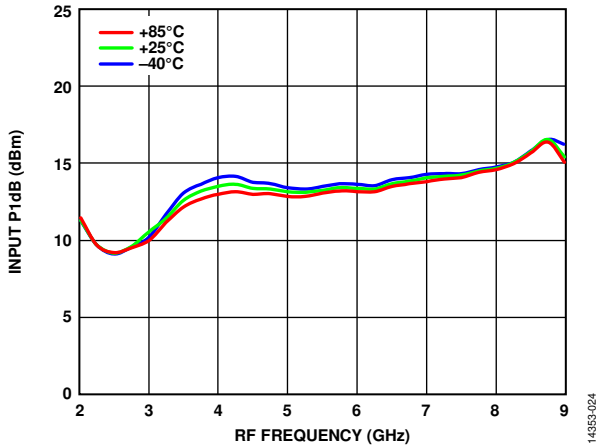

Figure 24. Input P1dB vs. RF Frequency at Various Temperatures

143353-023

143353-025

143353-024

**Downconverter Performance at IF = 3500 MHz, Lower Sideband**

Data taken at LO drive = 18 dBm and T<sub>A</sub> = 25°C, unless otherwise noted.

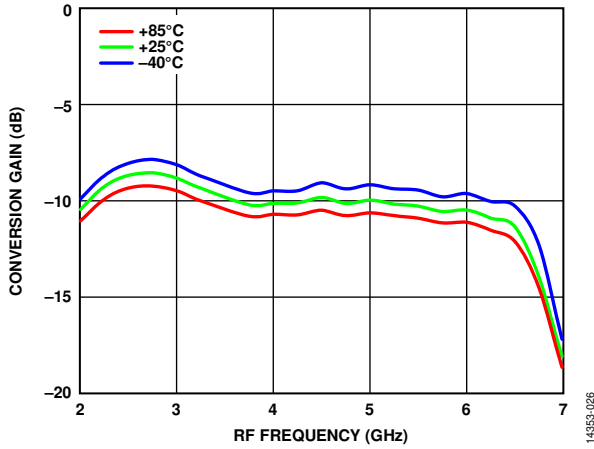

Figure 26. Conversion Gain vs. RF Frequency at Various Temperatures

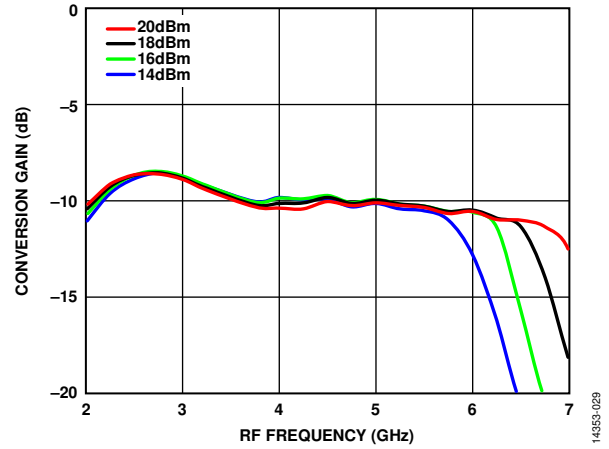

Figure 29. Conversion Gain vs. RF Frequency at Various LO Drives

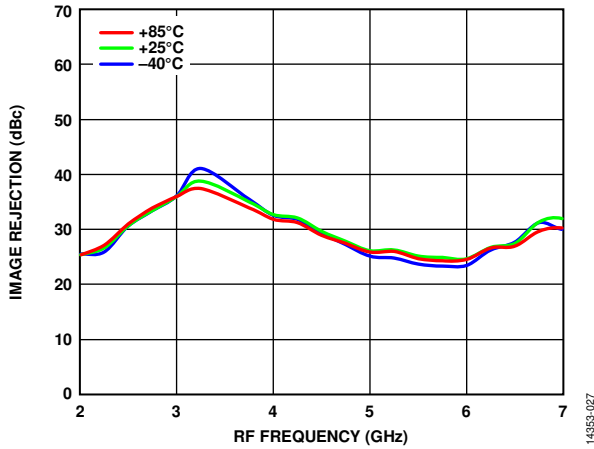

Figure 27. Image Rejection vs. RF Frequency at Various Temperatures

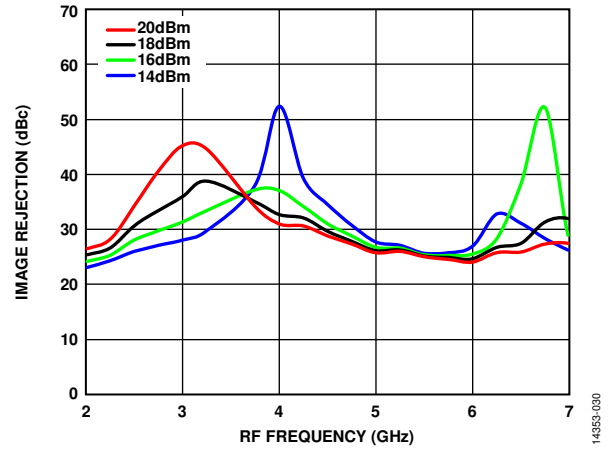

Figure 30. Image Rejection vs. RF Frequency at Various LO Drives

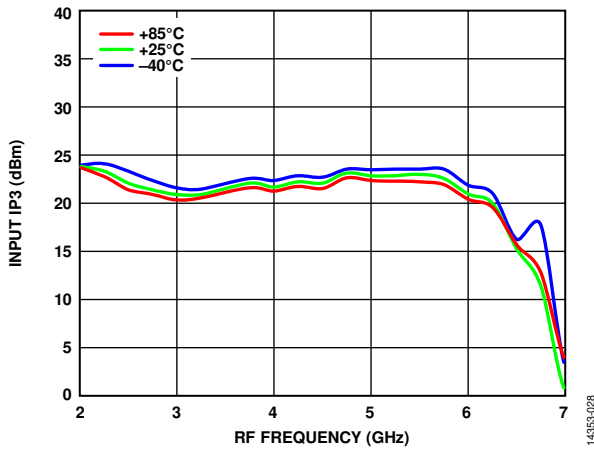

Figure 28. Input IP3 vs. RF Frequency at Various Temperatures

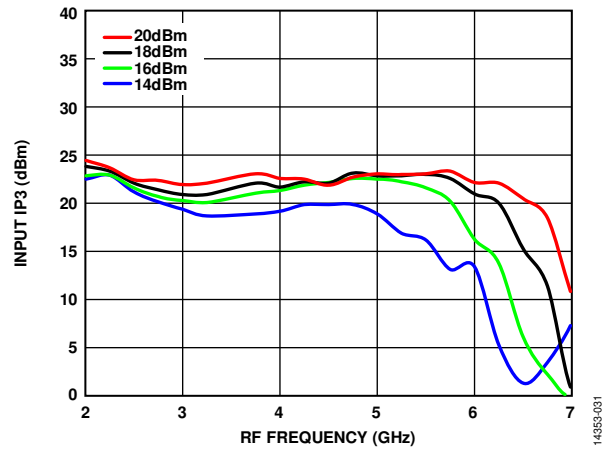

Figure 31. Input IP3 vs. RF Frequency at Various LO Drives

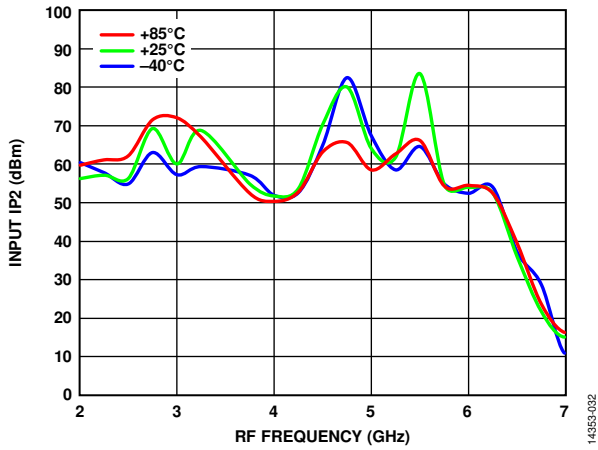

Figure 32. Input IP2 vs. RF Frequency at Various Temperatures

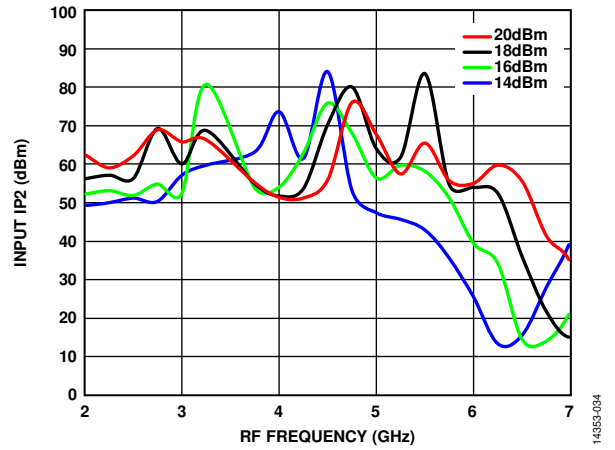

Figure 34. Input IP2 vs. RF Frequency at Various LO Drives

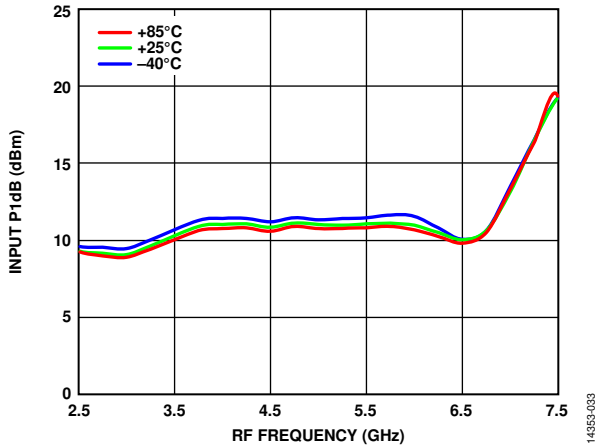

Figure 33. Input P1dB vs. RF Frequency at Various Temperatures

**Downconverter Performance at IF = 100 MHz, Upper Sideband**

Data taken at LO drive = 18 dBm and T<sub>A</sub> = 25°C, unless otherwise noted.

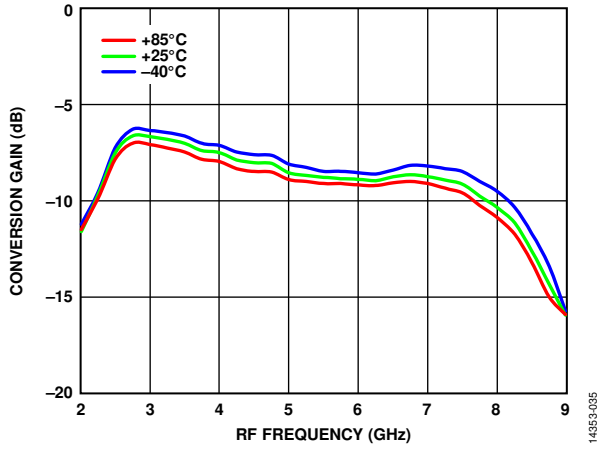

Figure 35. Conversion Gain vs. RF Frequency at Various Temperatures

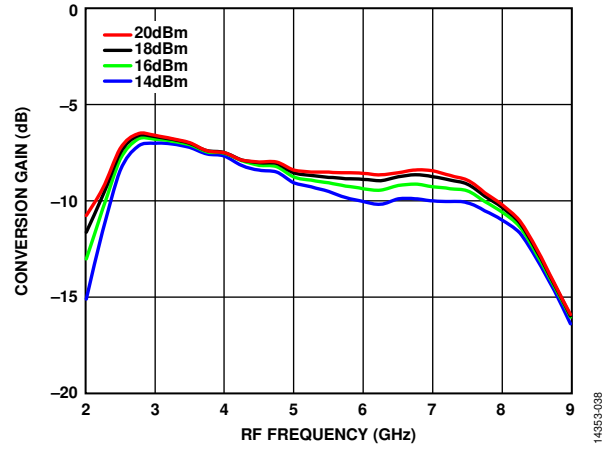

Figure 38. Conversion Gain vs. RF Frequency at Various LO Drives

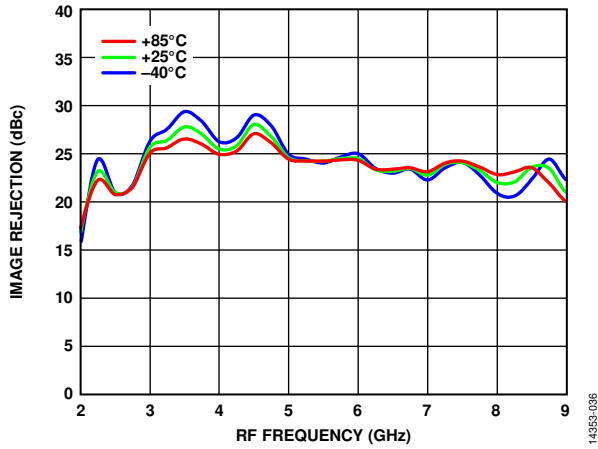

Figure 36. Image Rejection vs. RF Frequency at Various Temperatures

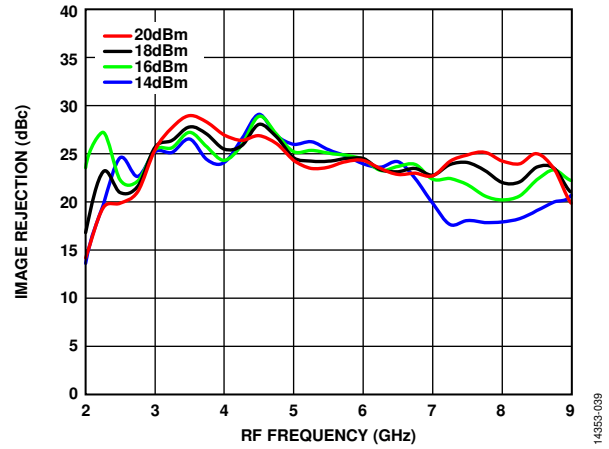

Figure 39. Image Rejection vs. RF Frequency at Various LO Drives

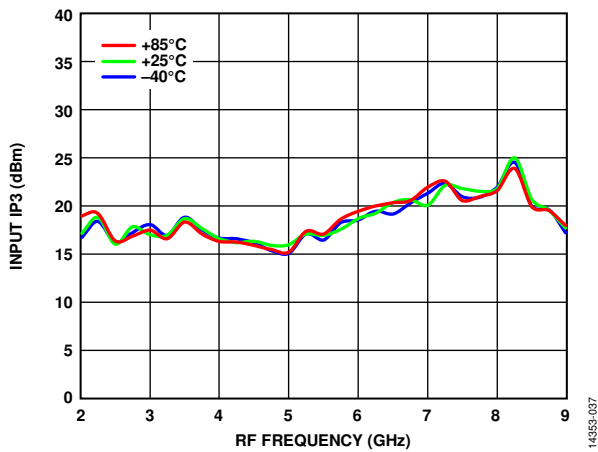

Figure 37. Input IP3 vs. RF Frequency at Various Temperatures

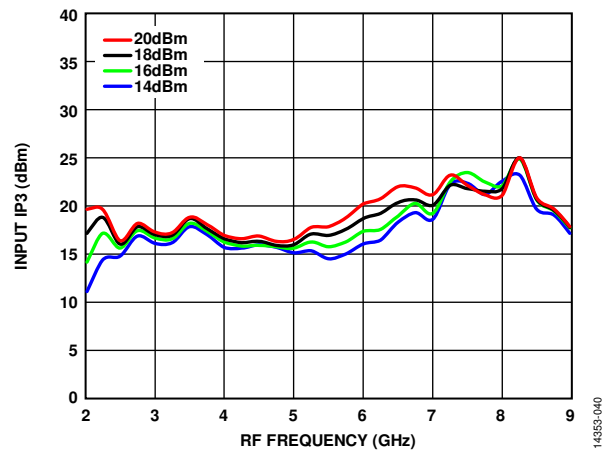

Figure 40. Input IP3 vs. RF Frequency at Various LO Drives

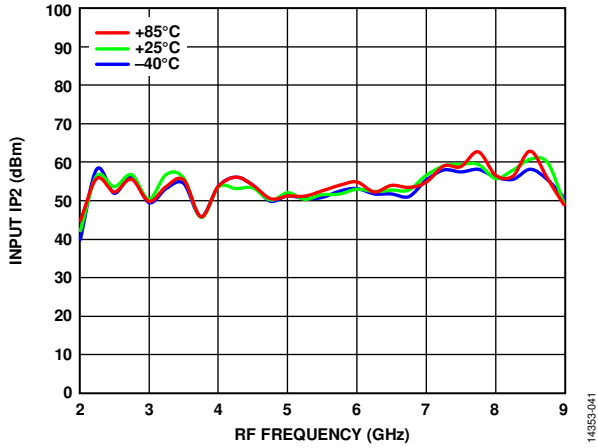

Figure 41. Input IP2 vs. RF Frequency at Various Temperatures

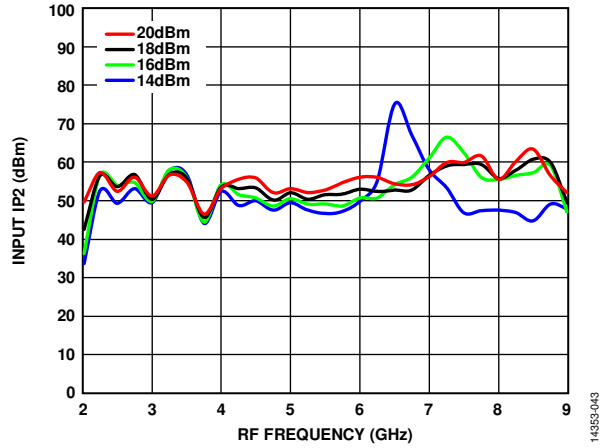

Figure 43. Input IP2 vs. RF Frequency at Various LO Drives

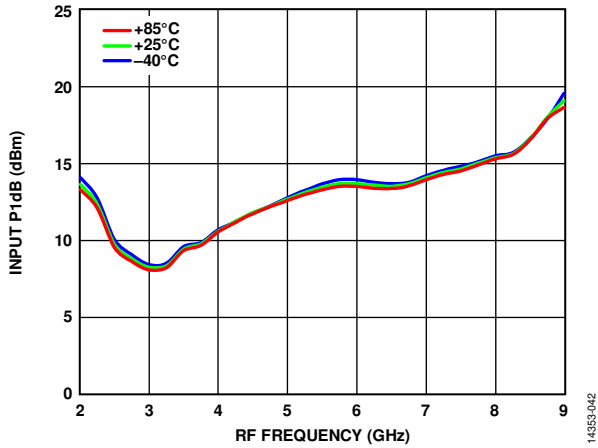

Figure 42. Input P1dB vs. RF Frequency at Various Temperatures

14353-041

14353-043

14353-042

**Downconverter Performance at IF = 1000 MHz, Upper Sideband**

Data taken at LO drive = 18 dBm and T<sub>A</sub> = 25°C, unless otherwise noted.

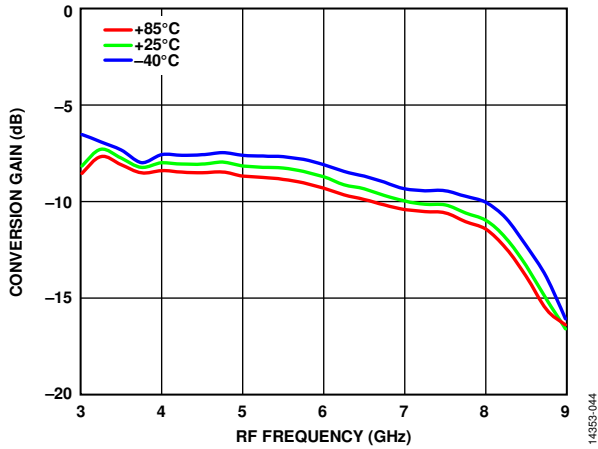

Figure 44. Conversion Gain vs. RF Frequency at Various Temperatures

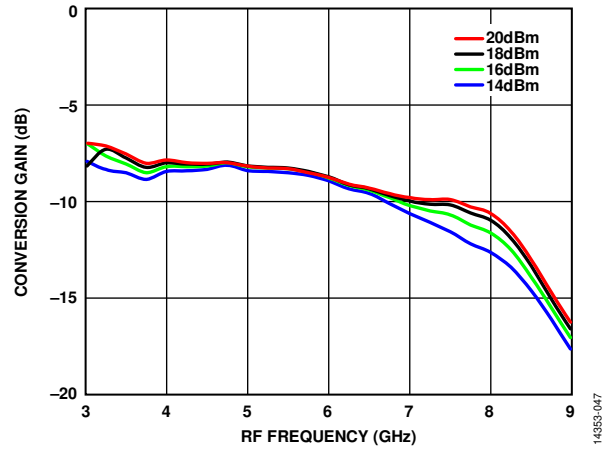

Figure 47. Conversion Gain vs. RF Frequency at Various LO Drives

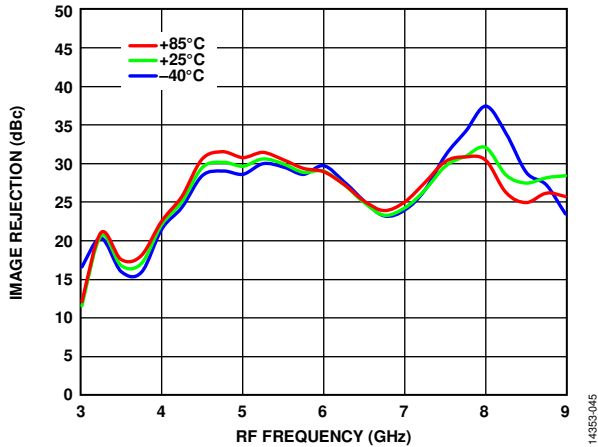

Figure 45. Image Rejection vs. RF Frequency at Various Temperatures

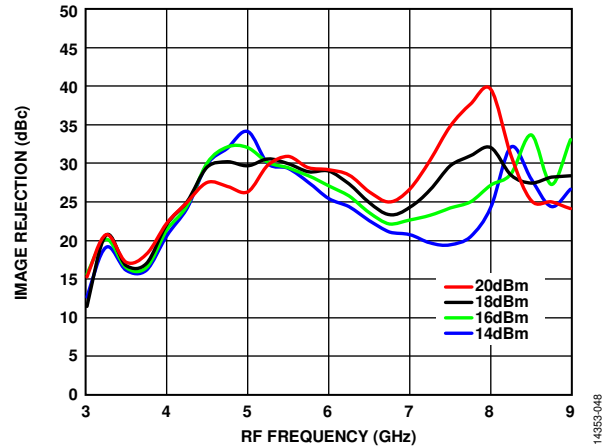

Figure 48. Image Rejection vs. RF Frequency at Various LO Drives

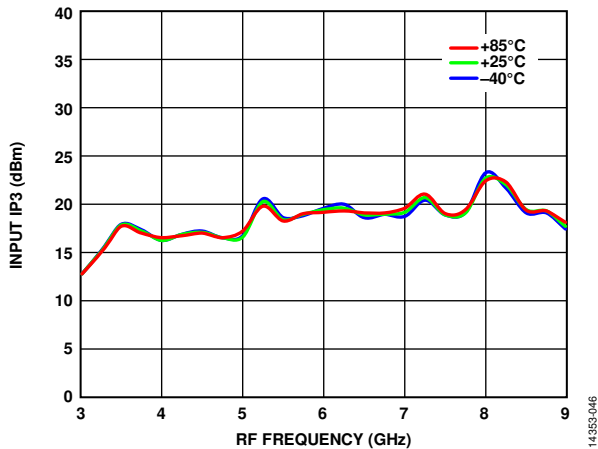

Figure 46. Input IP3 vs. RF Frequency at Various Temperatures

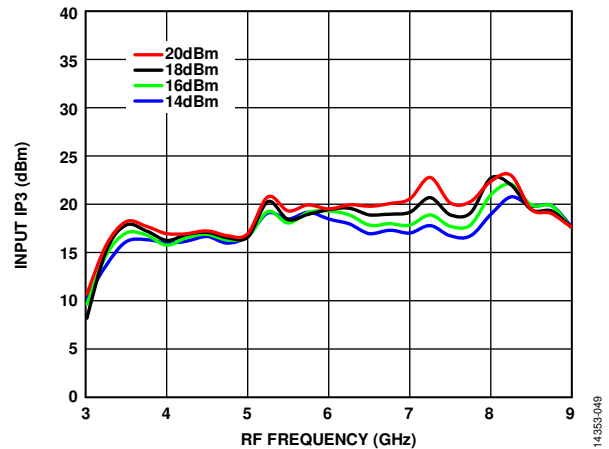

Figure 49. Input IP3 vs. RF Frequency at Various LO Drives

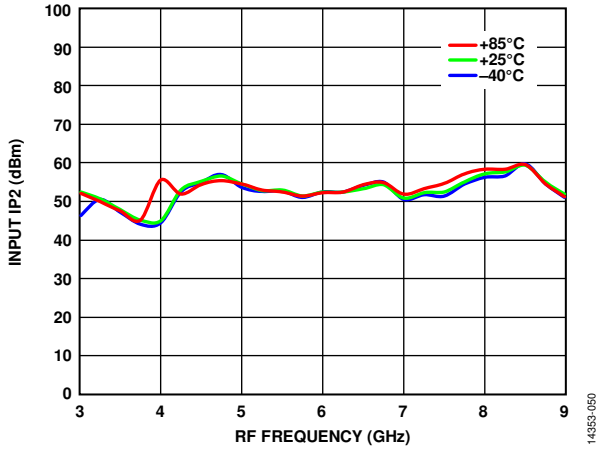

Figure 50. Input IP2 vs. RF Frequency at Various Temperatures

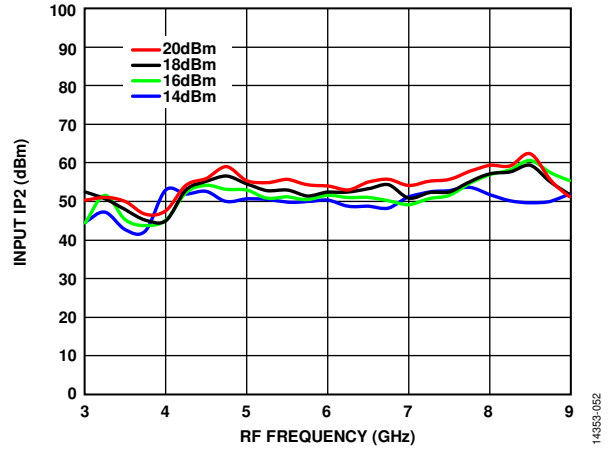

Figure 52. Input IP2 vs. RF Frequency at Various LO Drives

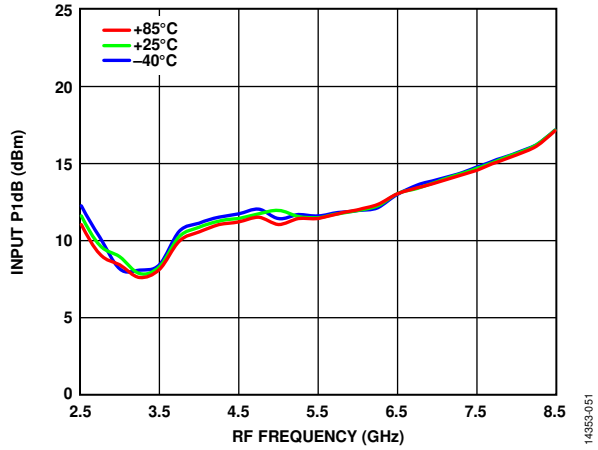

Figure 51. Input P1dB vs. RF Frequency at Various Temperatures



**Downconverter Performance at IF = 3500 MHz, Upper Sideband**

Data taken at LO drive = 18 dBm and T<sub>A</sub> = 25°C, unless otherwise noted.

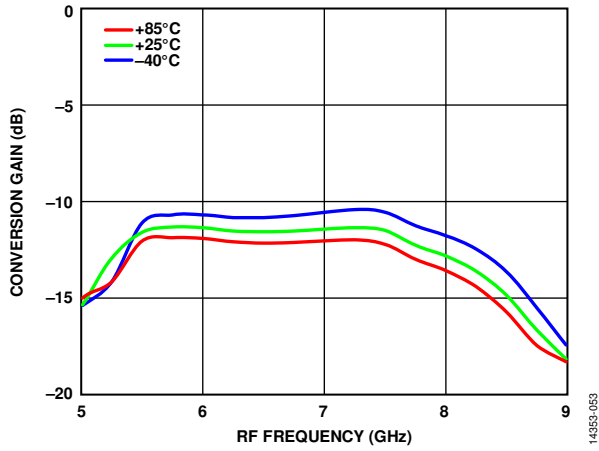

Figure 53. Conversion Gain vs. RF Frequency at Various Temperatures

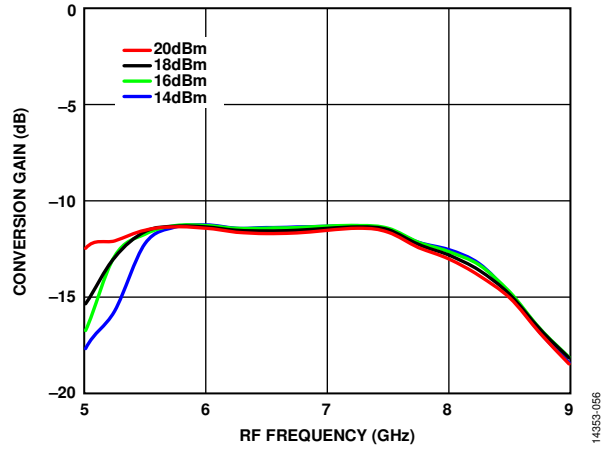

Figure 55. Conversion Gain vs. RF Frequency at Various LO Drives

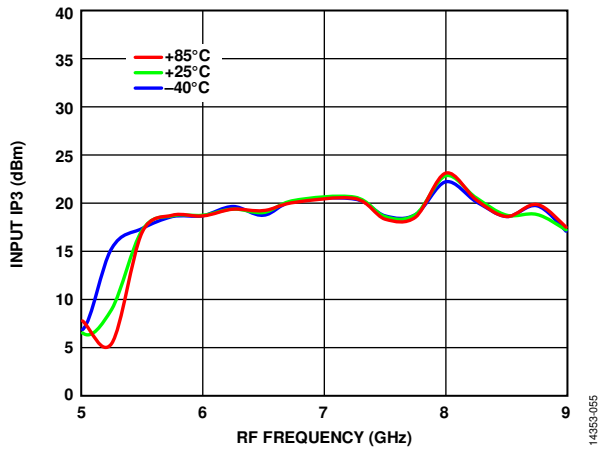

Figure 54. Input IP3 vs. RF Frequency at Various Temperatures

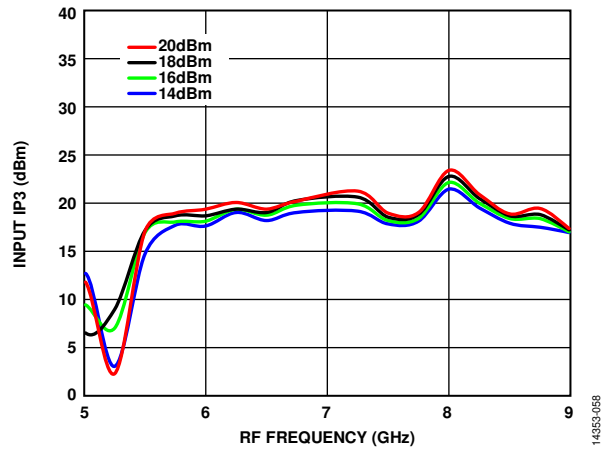

Figure 56. Input IP3 vs. RF Frequency at Various LO Drives

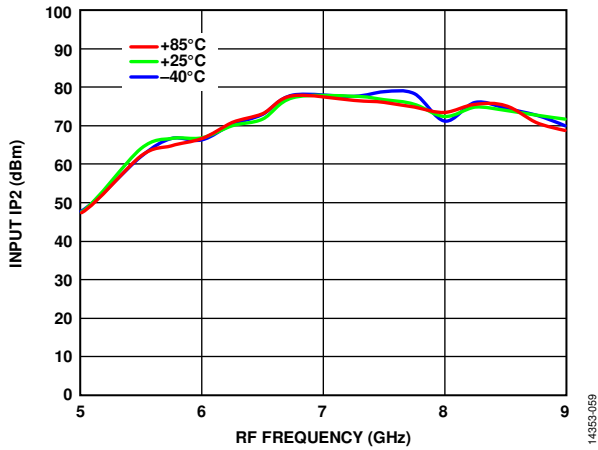

Figure 57. Input IP2 vs. RF Frequency at Various Temperatures

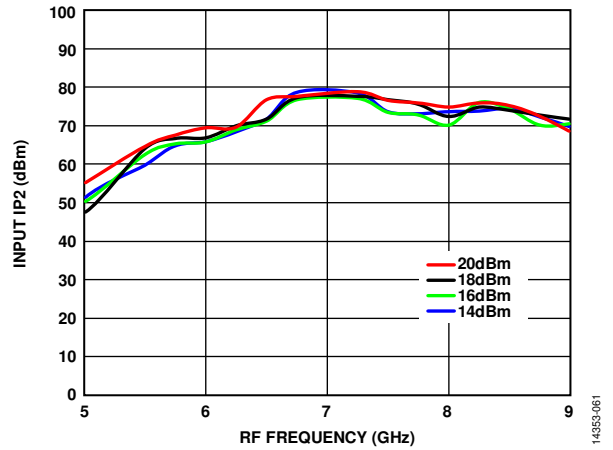

Figure 59. Input IP2 vs. RF Frequency at Various LO Drives

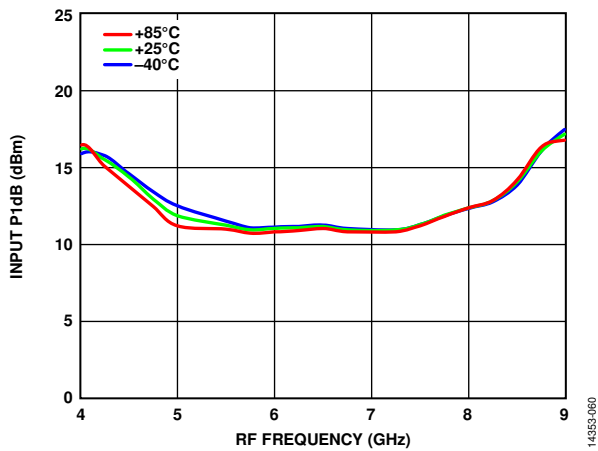

Figure 58. Input P1dB vs. RF Frequency at Various Temperatures

**UPCONVERTER PERFORMANCE**

**Upconverter Performance at IF = 100 MHz, Lower Sideband**

Data taken at LO drive = 18 dBm and T<sub>A</sub> = 25°C, unless otherwise noted.

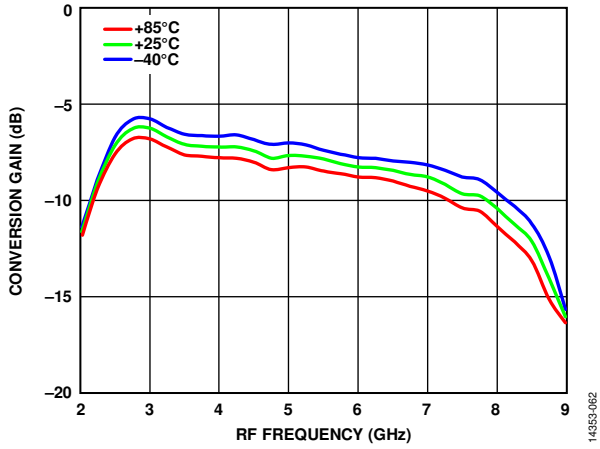

Figure 60. Conversion Gain vs. RF Frequency at Various Temperatures

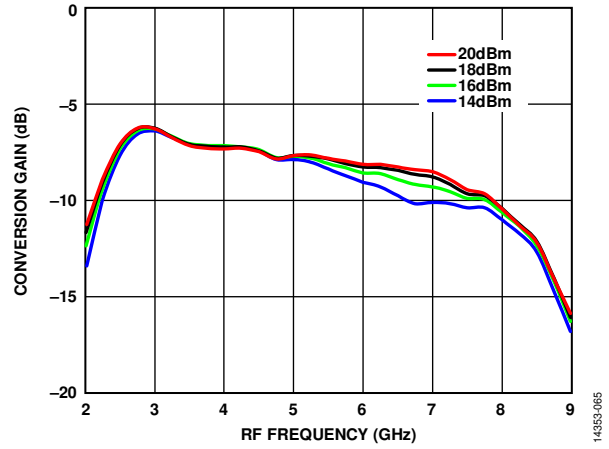

Figure 63. Conversion Gain vs. RF Frequency at Various LO Drives

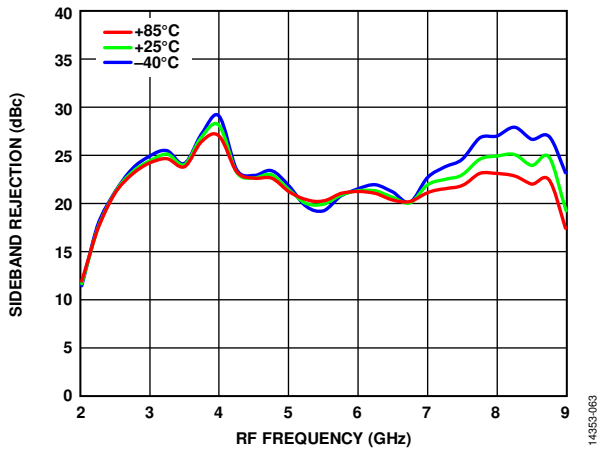

Figure 61. Sideband Rejection vs. RF Frequency at Various Temperatures

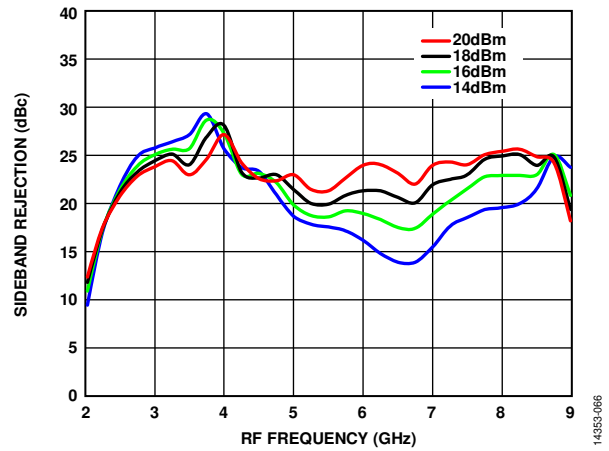

Figure 64. Sideband Rejection vs. RF Frequency at Various LO Drives

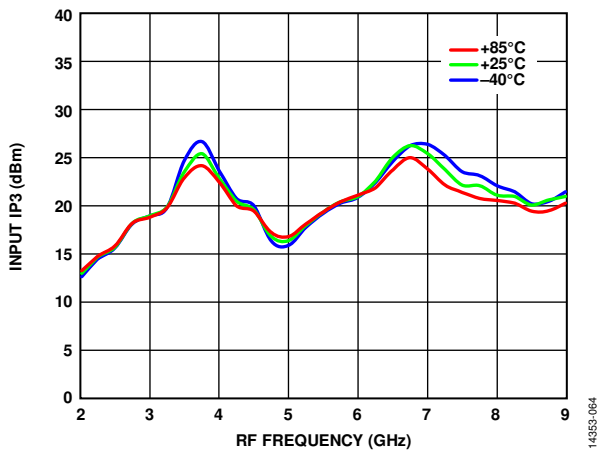

Figure 62. Input IP3 vs. RF Frequency at Various Temperatures

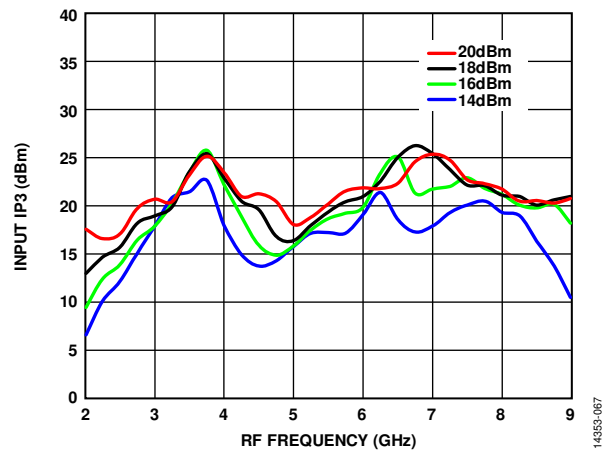

Figure 65. Input IP3 vs. RF Frequency at Various LO Drives

**Upconverter Performance at IF = 1000 MHz, Lower Sideband**

Data taken at LO drive = 18 dBm and  $T_A = 25^\circ\text{C}$ , unless otherwise noted.

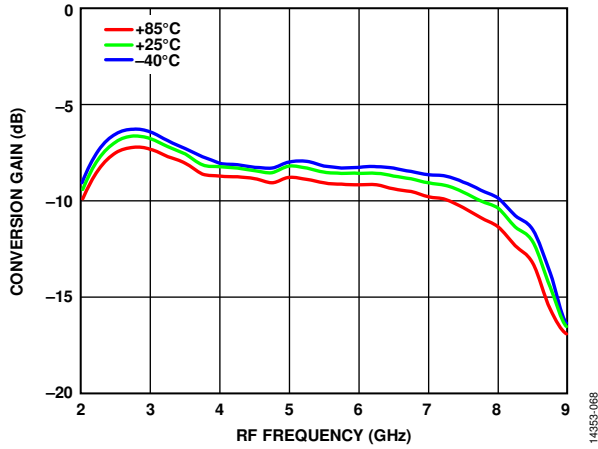

Figure 66. Conversion Gain vs. RF Frequency at Various Temperatures

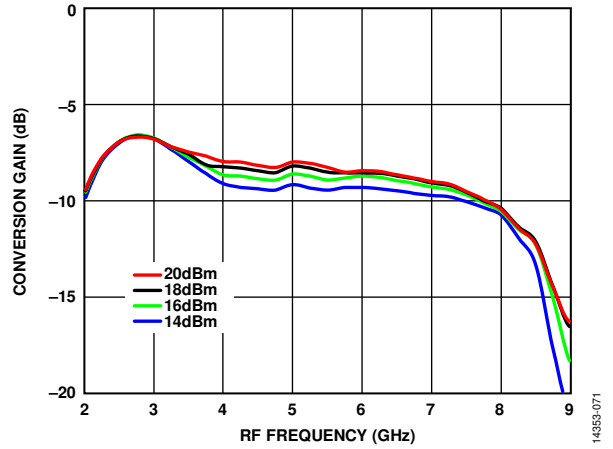

Figure 69. Conversion Gain vs. RF Frequency at Various LO Drives

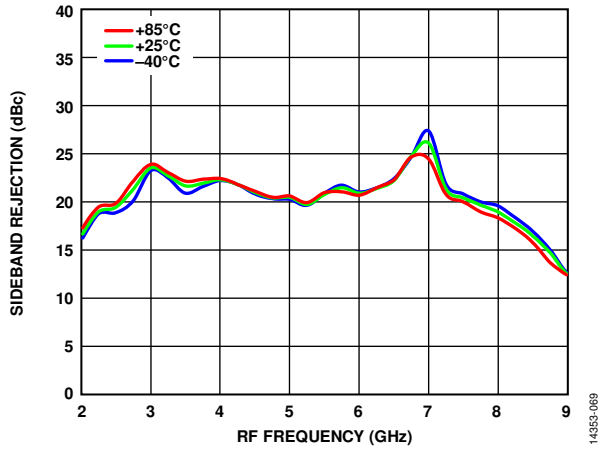

Figure 67. Sideband Rejection vs. RF Frequency at Various Temperatures

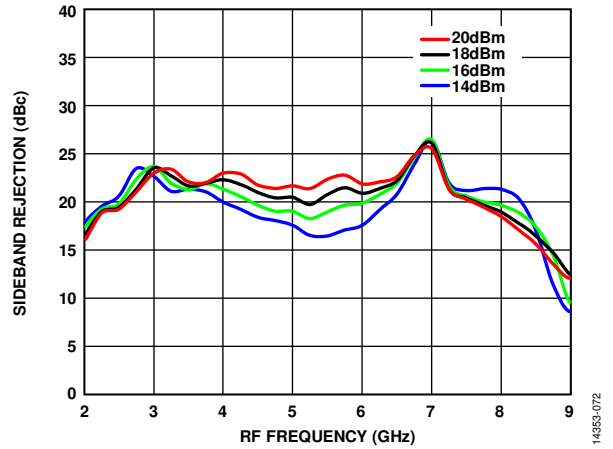

Figure 70. Sideband Rejection vs. RF Frequency at Various LO Drives

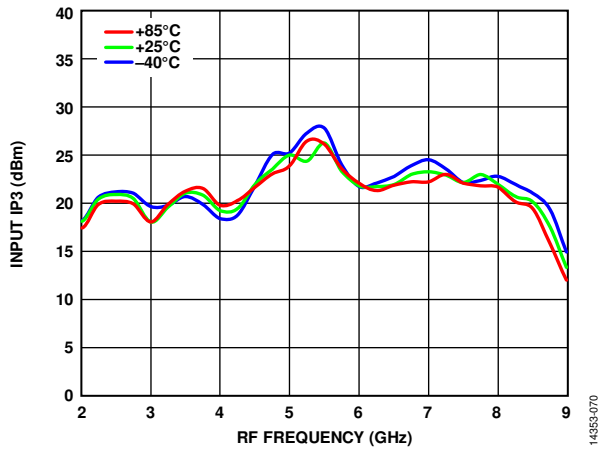

Figure 68. Input IP3 vs. RF Frequency at Various Temperatures

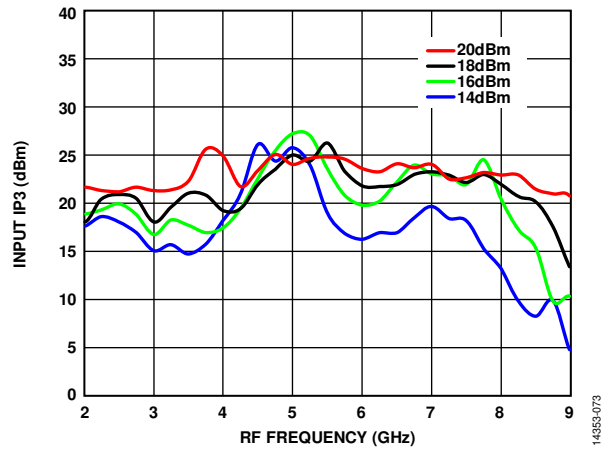

Figure 71. Input IP3 vs. RF Frequency at Various LO Drives

**Upconverter Performance at IF = 3500 MHz, Lower Sideband**

Data taken at LO drive = 18 dBm and T<sub>A</sub> = 25°C, unless otherwise noted.

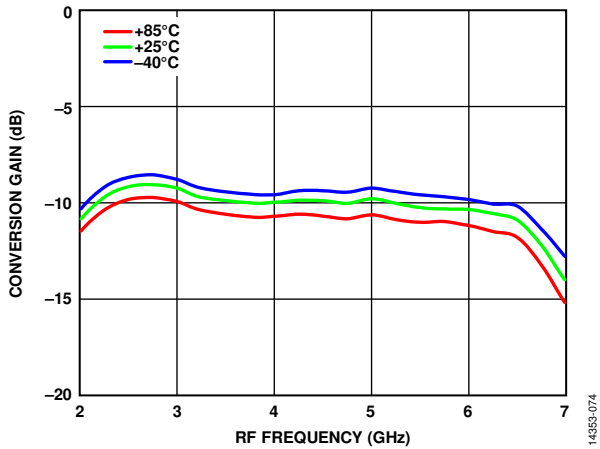

Figure 72. Conversion Gain vs. RF Frequency at Various Temperatures

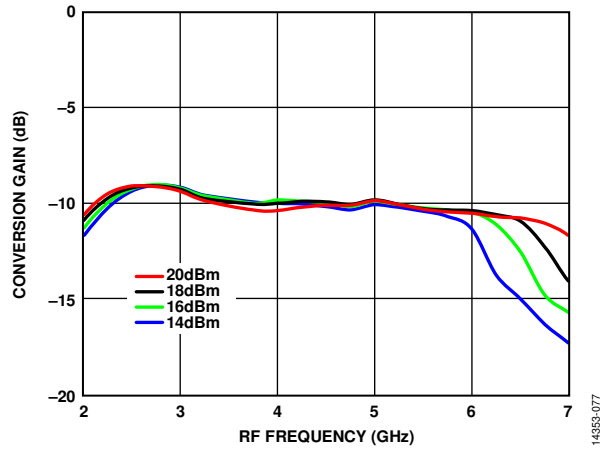

Figure 75. Conversion Gain vs. RF Frequency at Various LO Drives

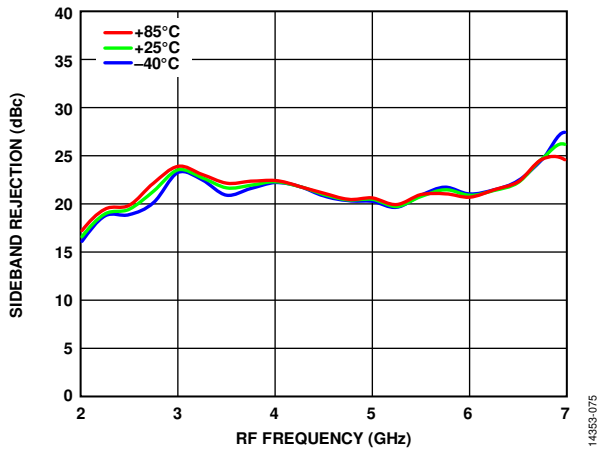

Figure 73. Sideband Rejection vs. RF Frequency at Various Temperatures

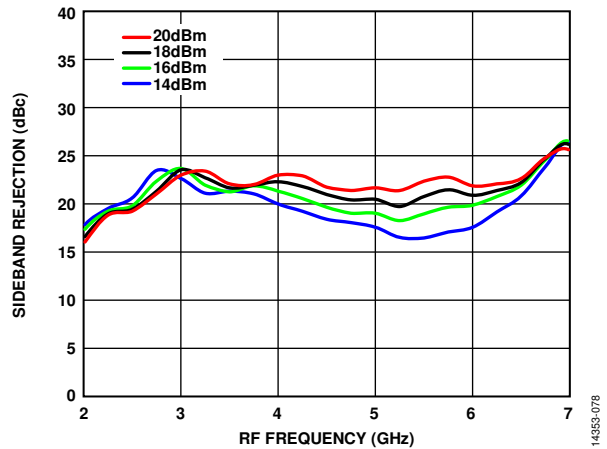

Figure 76. Sideband Rejection vs. RF Frequency at Various LO Drives

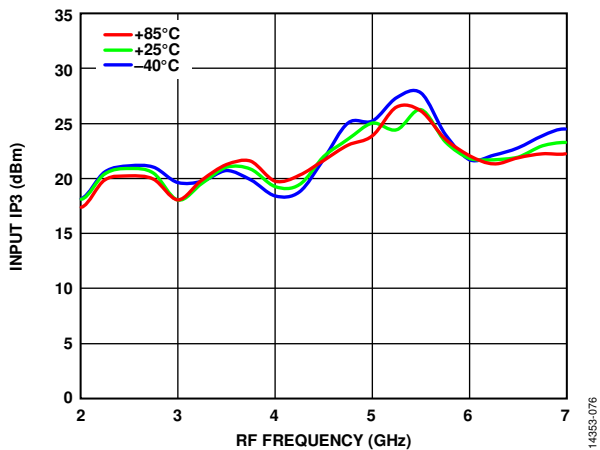

Figure 74. Input IP3 vs. RF Frequency at Various Temperatures

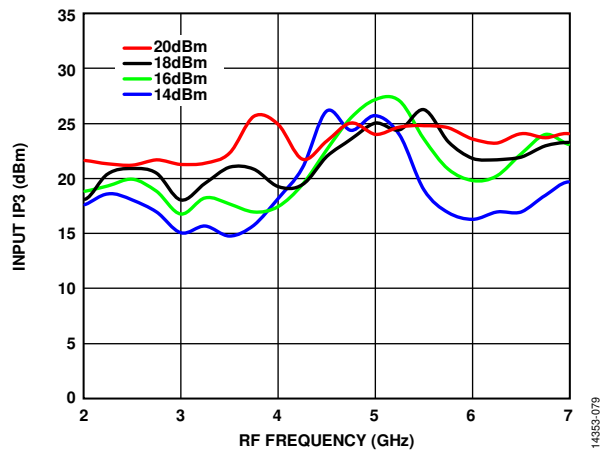

Figure 77. Input IP3 vs. RF Frequency at Various LO Drives

**Upconverter Performance at IF = 100 MHz, Upper Sideband**

Data taken at LO drive = 18 dBm and  $T_A = 25^\circ\text{C}$ , unless otherwise noted.

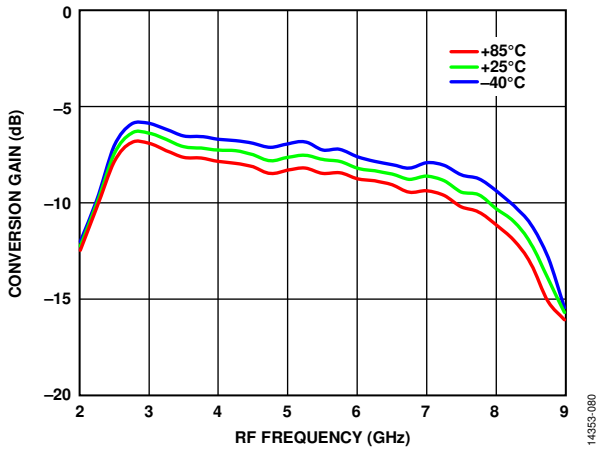

Figure 78. Conversion Gain vs. RF Frequency at Various Temperatures

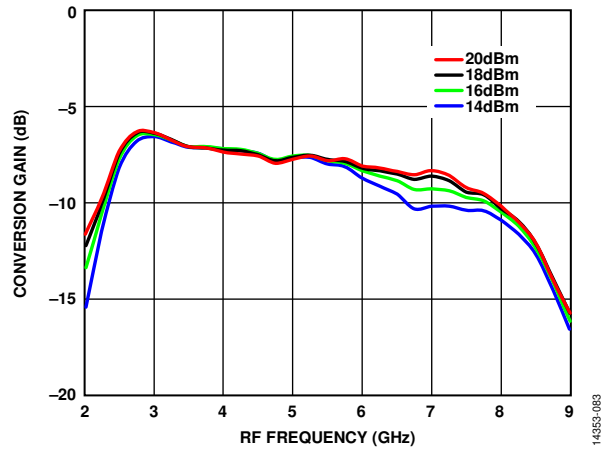

Figure 81. Conversion Gain vs. RF Frequency at Various LO Drives

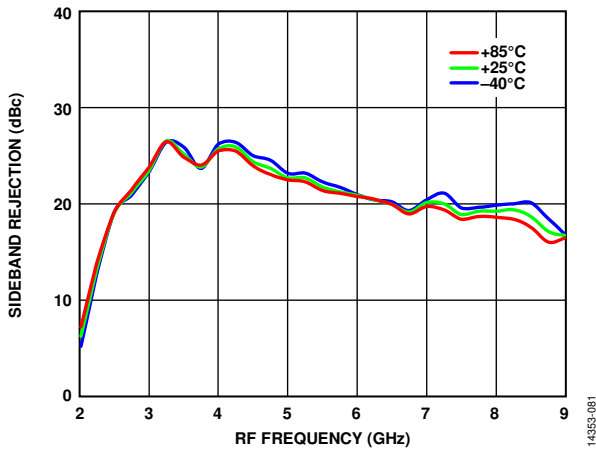

Figure 79. Sideband Rejection vs. RF Frequency at Various Temperatures

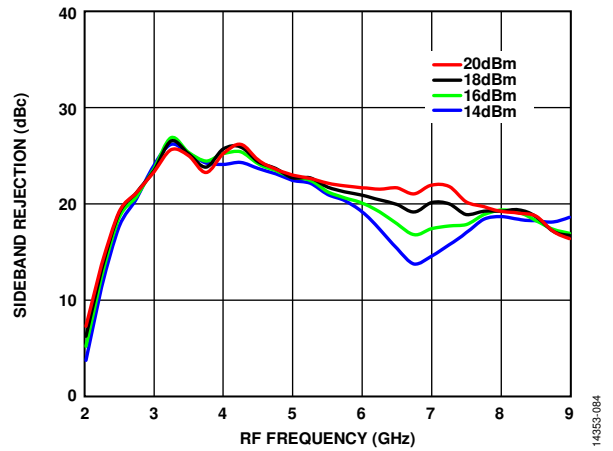

Figure 82. Sideband Rejection vs. RF Frequency at Various LO Drives

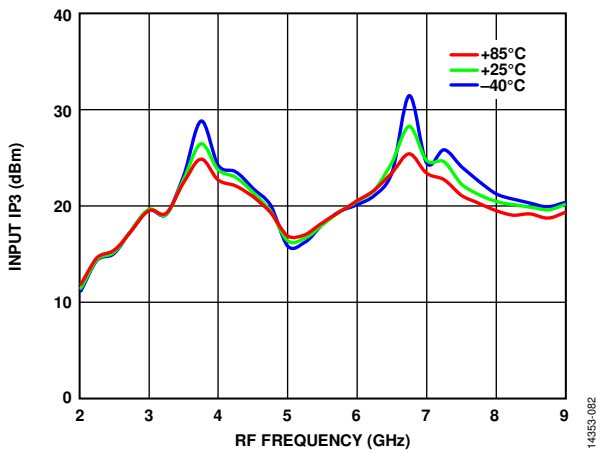

Figure 80. Input IP3 vs. RF Frequency at Various Temperatures

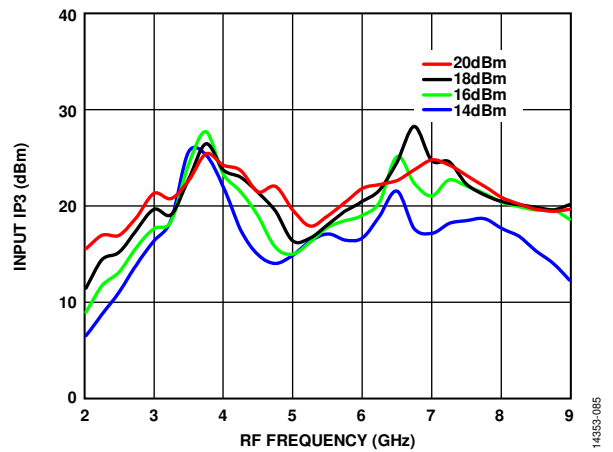

Figure 83. Input IP3 vs. RF Frequency at Various LO Drives

**Upconverter Performance at IF = 1000 MHz, Upper Sideband**

Data taken at LO drive = 18 dBm and T<sub>A</sub> = 25°C, unless otherwise noted.

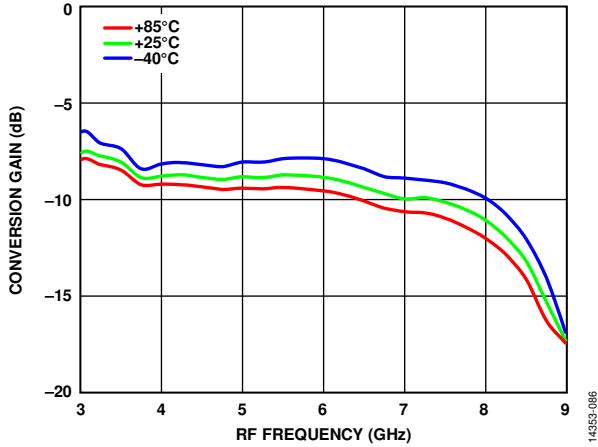

Figure 84. Conversion Gain vs. RF Frequency at Various Temperatures

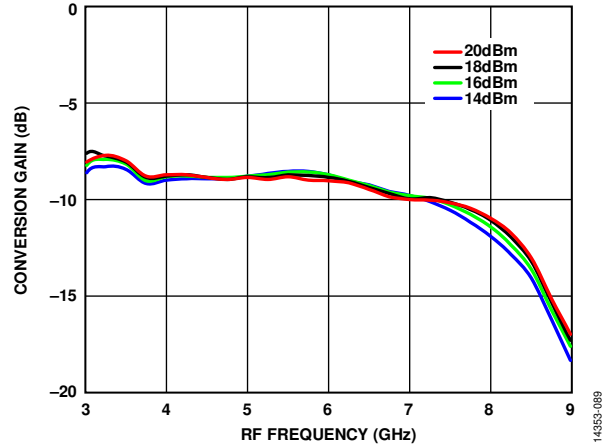

Figure 87. Conversion Gain vs. RF Frequency at Various LO Drives

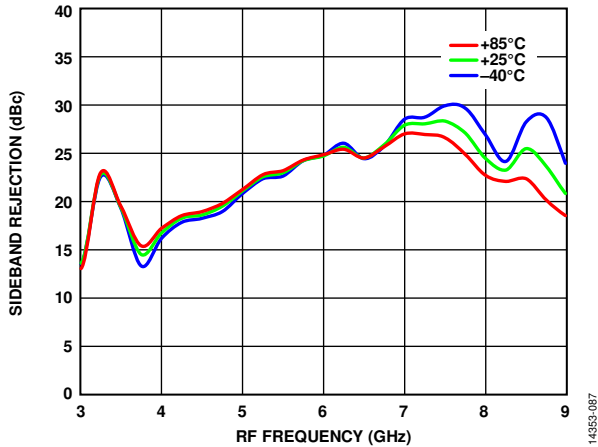

Figure 85. Sideband Rejection vs. RF Frequency at Various Temperatures

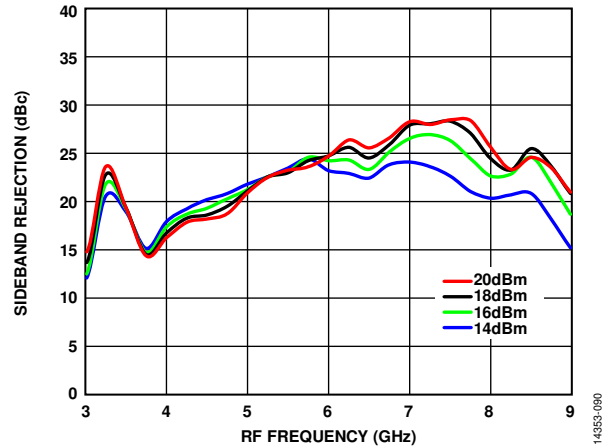

Figure 88. Sideband Rejection vs. RF Frequency at Various LO Drives

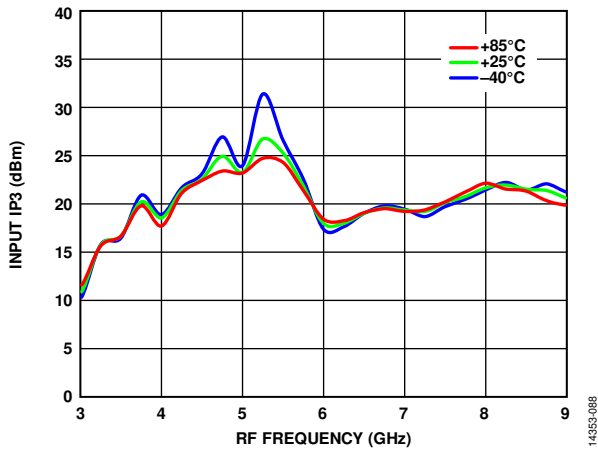

Figure 86. Input IP3 vs. RF Frequency at Various Temperatures

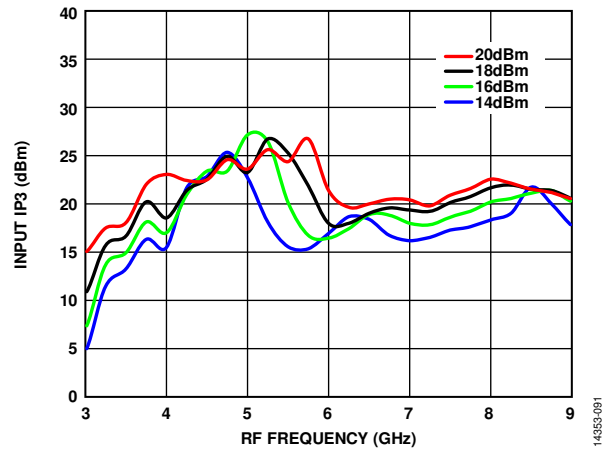

Figure 89. Input IP3 vs. RF Frequency at Various LO Drives

**Upconverter Performance at IF = 3500 MHz, Upper Sideband**

Data taken at LO drive = 18 dBm and T<sub>A</sub> = 25°C, unless otherwise noted.

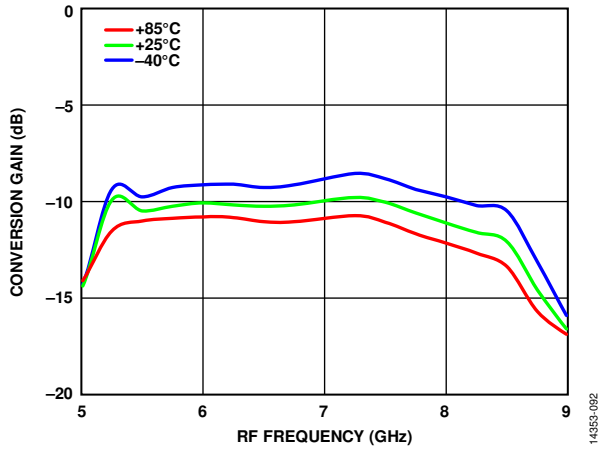

Figure 90. Conversion Gain vs. RF Frequency at Various Temperatures

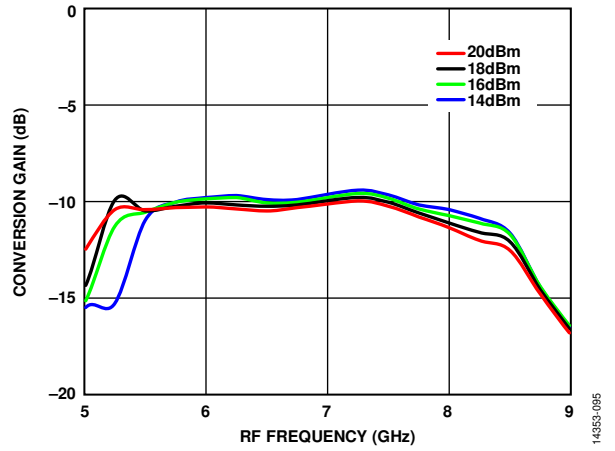

Figure 92. Conversion Gain vs. RF Frequency at Various LO Drives

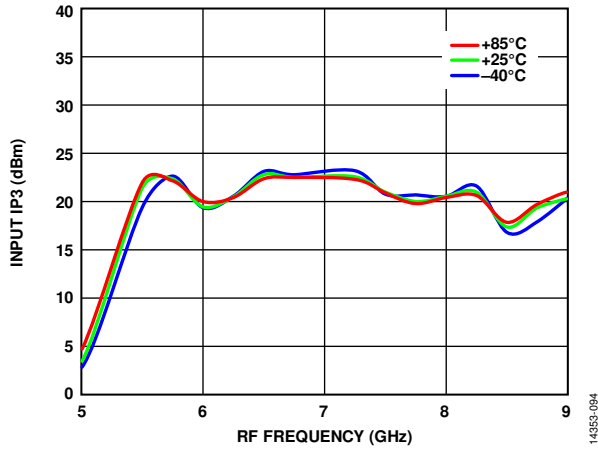

Figure 91. Input IP3 vs. RF Frequency at Various Temperatures

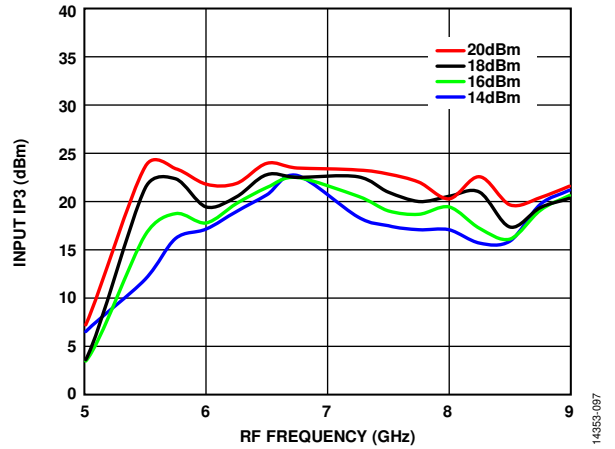

Figure 93. Input IP3 vs. RF Frequency at Various LO Drives



**ISOLATION AND RETURN LOSS**

Data taken at LO drive = 18 dBm, T<sub>A</sub> = 25°C, unless otherwise noted.

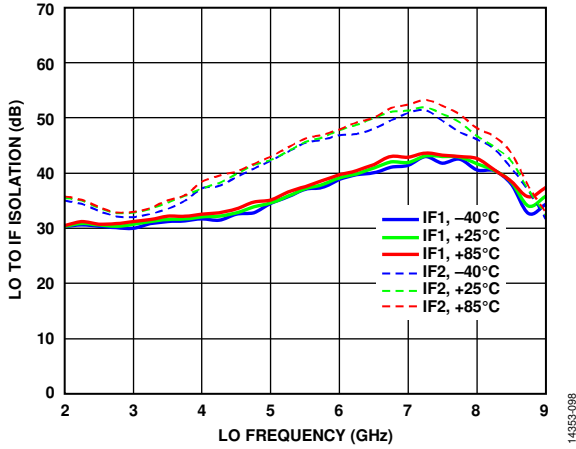

Figure 94. LO to IF Isolation vs. LO Frequency at Various Temperatures

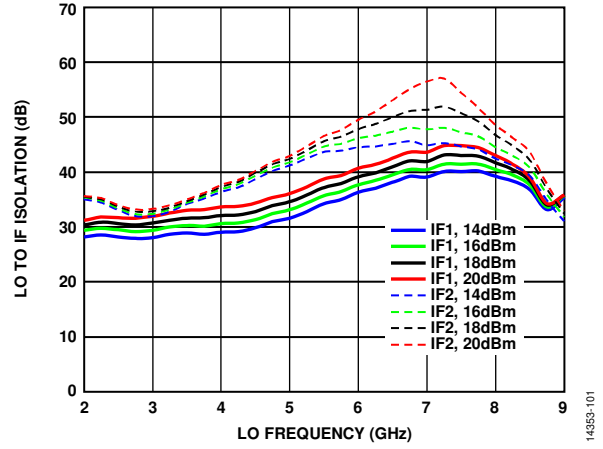

Figure 97. LO to IF Isolation vs. LO Frequency at Various LO Drives

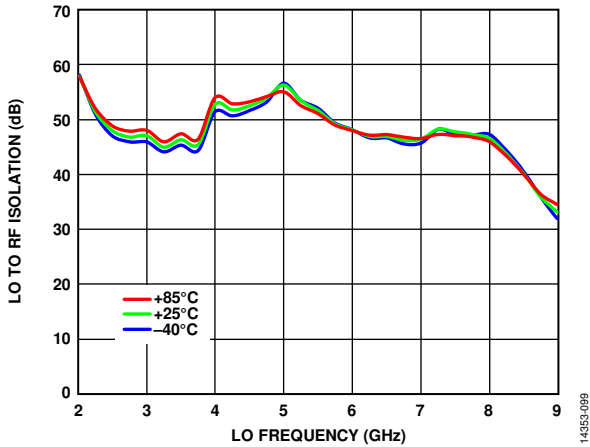

Figure 95. LO to RF Isolation vs. LO Frequency at Various Temperatures

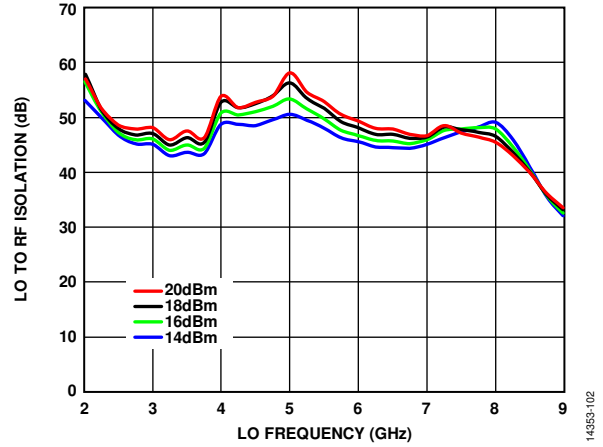

Figure 98. LO to RF Isolation vs. LO Frequency at Various LO Drives

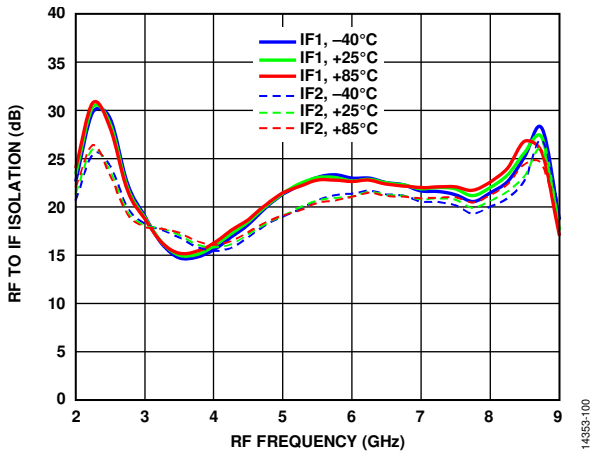

Figure 96. RF to IF Isolation vs. RF Frequency at Various Temperatures

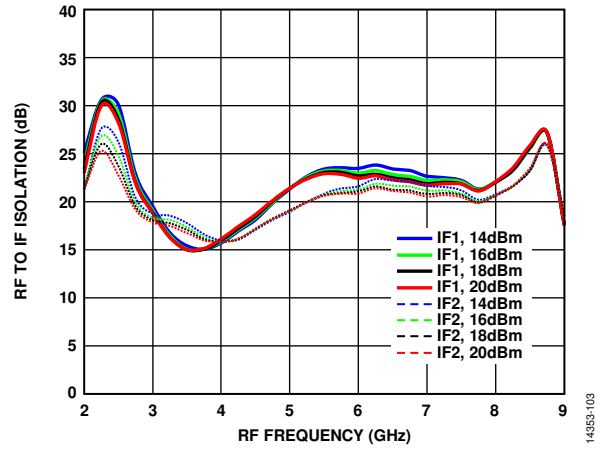

Figure 99. RF to IF Isolation vs. RF Frequency at Various LO Drives

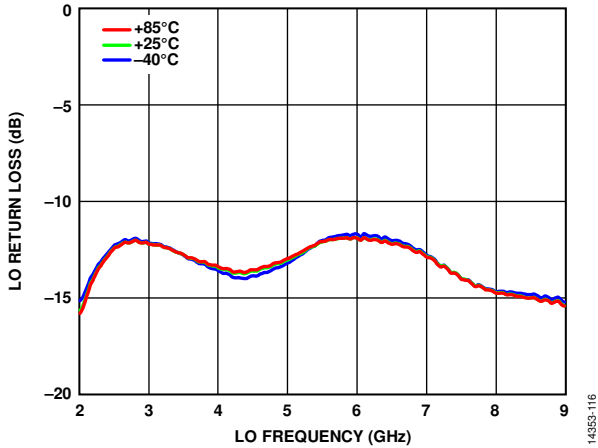

Figure 100. LO Return Loss vs. LO Frequency at Various Temperatures

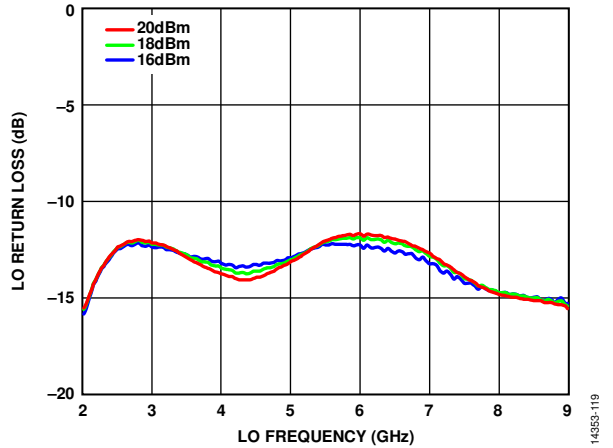

Figure 103. LO Return Loss vs. LO Frequency at Various LO Drives

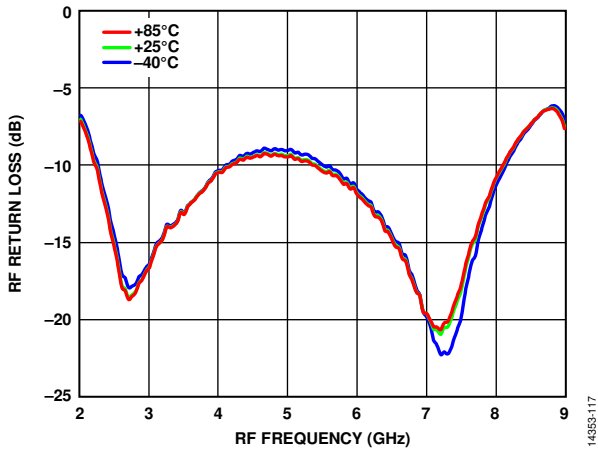

Figure 101. RF Return Loss vs. RF Frequency at Various Temperatures  
LO Frequency = 5.5 GHz

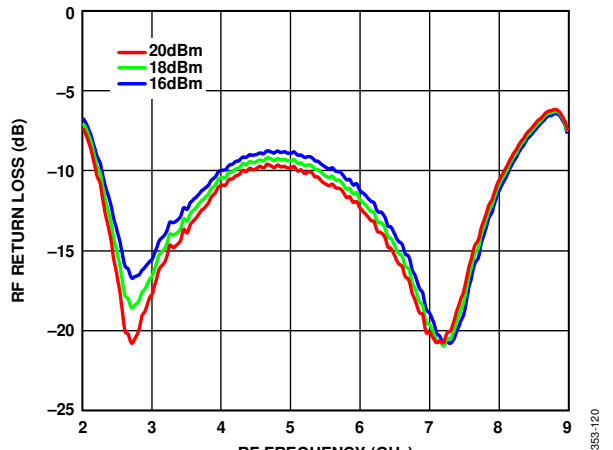

Figure 104. RF Return Loss vs. RF Frequency at Various LO Drives  
LO Frequency = 5.5 GHz

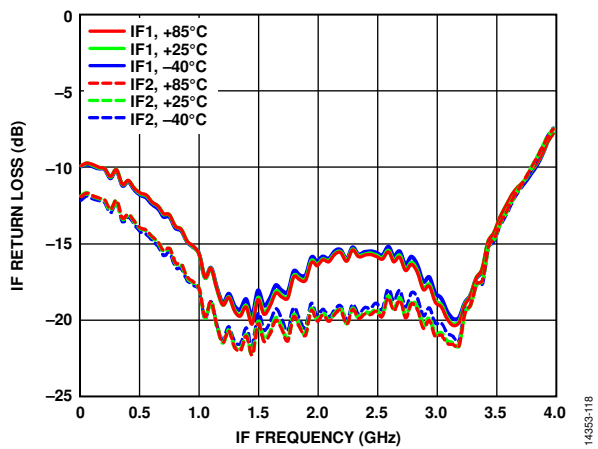

Figure 102. IF Return Loss vs. IF Frequency at Various Temperatures  
LO Frequency = 5.5 GHz

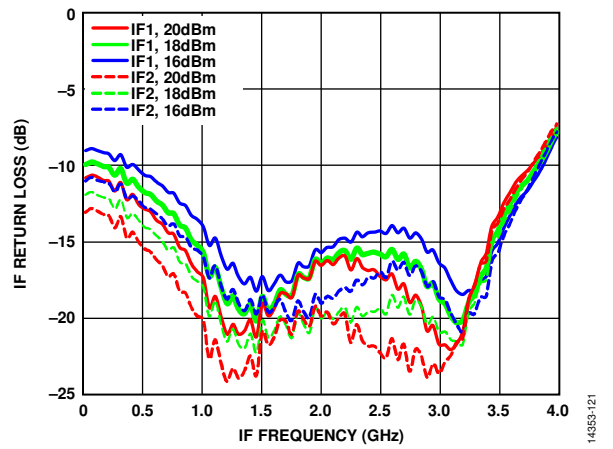

Figure 105. IF Return Loss vs. IF Frequency at Various LO Drives  
LO Frequency = 5.5 GHz