



Chipsmall Limited consists of a professional team with an average of over 10 year of expertise in the distribution of electronic components. Based in Hongkong, we have already established firm and mutual-benefit business relationships with customers from,Europe,America and south Asia,supplying obsolete and hard-to-find components to meet their specific needs.

With the principle of "Quality Parts,Customers Priority,Honest Operation,and Considerate Service",our business mainly focus on the distribution of electronic components. Line cards we deal with include Microchip,ALPS,ROHM,Xilinx,Pulse,ON,Everlight and Freescale. Main products comprise IC,Modules,Potentiometer,IC Socket,Relay,Connector.Our parts cover such applications as commercial,industrial, and automotives areas.

We are looking forward to setting up business relationship with you and hope to provide you with the best service and solution. Let us make a better world for our industry!



Contact us

Tel: +86-755-8981 8866 Fax: +86-755-8427 6832

Email & Skype: info@chipsmall.com Web: www.chipsmall.com

Address: A1208, Overseas Decoration Building, #122 Zhenhua RD., Futian, Shenzhen, China



GaAs pHEMT MMIC 1/2 WATT POWER AMPLIFIER, 22 - 26.5 GHz



Typical Applications

The HMC863LP4E is ideal for:

- Point-to-Point Radios
- Point-to-Multi-Point Radios
- VSAT
- Military & Space

Features

- Saturated Output Power:
up to +27.5 dBm @ 15% PAE
- High Output IP3: +33 dBm
- High Gain: 21.5 dB
- DC Supply: +6V @ 350mA
- No External Matching Required
- 24 Lead 4x4 mm SMT Package: 16 mm²

Functional Diagram

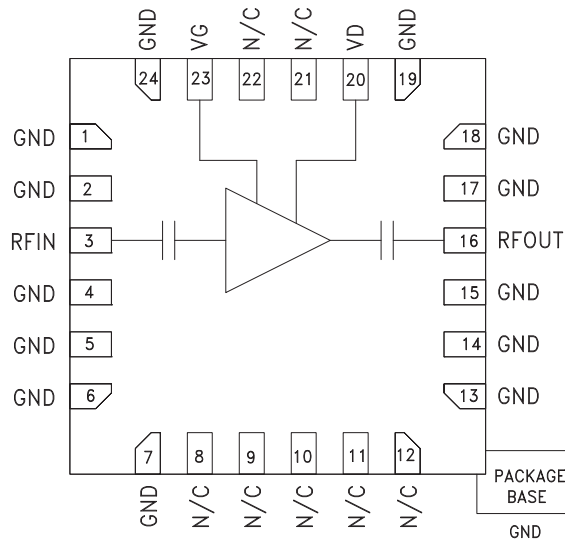

General Description

The HMC863LP4E is a three stage GaAs pHEMT MMIC 1/2 Watt Power Amplifier which operates between 22 and 26.5 GHz. The HMC863LP4E provides 21.5 dB of gain, +27.5 dBm of saturated output power and 15% PAE from a +6V supply. High output IP3 makes the HMC863LP4E ideal for point-to-point and point-to-multi-point radio systems as well as VSAT applications. The RF I/Os are DC blocked and matched to 50 Ohms for ease of integration into higher level assemblies. The HMC863LP4E can also be operated from a 5V supply with only a slight decrease in output power & IP3.

Electrical Specifications, $T_A = +25^\circ C$, $V_{dd} = V_{dd1} = V_{dd2} = +6V$, $I_{dd} = 350mA$ [1]

Parameter	Min.	Typ.	Max.	Units
Frequency Range	22 - 26.5			GHz
Gain	19	21.5		dB
Gain Variation Over Temperature		0.032		dB/°C
Input Return Loss		11		dB
Output Return Loss		15		dB
Output Power for 1 dB Compression (P1dB)	22	24.5		dBm
Saturated Output Power (P _{sat})		27		dBm
Output Third Order Intercept (IP ₃) ^[2]		33		dBm
Total Supply Current (I _{dd})		350	380	mA

[1] Adjust V_{gg} between -2 to 0V to achieve I_{dd} = 350mA typical.

[2] Measurement taken at +6V @ 350mA, P_{out} / Tone = +14 dBm

HMC863* PRODUCT PAGE QUICK LINKS

Last Content Update: 02/23/2017

COMPARABLE PARTS

View a parametric search of comparable parts.

EVALUATION KITS

- HMC863LP4E Evaluation Board

DOCUMENTATION

Data Sheet

- HMC863 Die Data Sheet
- HMC863LP4E Data Sheet

REFERENCE MATERIALS

Quality Documentation

- Package/Assembly Qualification Test Report: LP4, LP4B, LP4C, LP4K (QTR: 2013-00487 REV: 04)
- Semiconductor Qualification Test Report: PHEMT-H (QTR: 2013-00260)

DESIGN RESOURCES

- HMC863 Material Declaration
- PCN-PDN Information
- Quality And Reliability
- Symbols and Footprints

DISCUSSIONS

View all HMC863 EngineerZone Discussions.

SAMPLE AND BUY

Visit the product page to see pricing options.

TECHNICAL SUPPORT

Submit a technical question or find your regional support number.

DOCUMENT FEEDBACK

Submit feedback for this data sheet.



**GaAs pHEMT MMIC 1/2 WATT
POWER AMPLIFIER, 22 - 26.5 GHz**

**Broadband Gain &
Return Loss vs. Frequency**

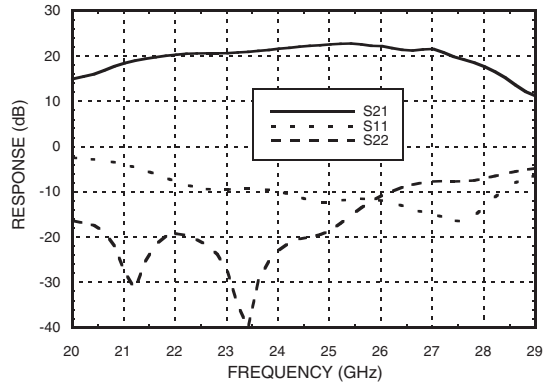

Gain vs. Temperature

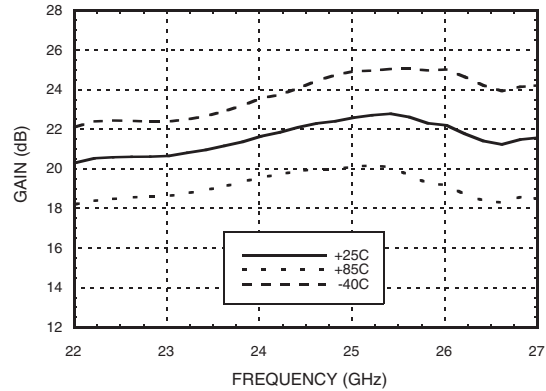

Input Return Loss vs. Temperature

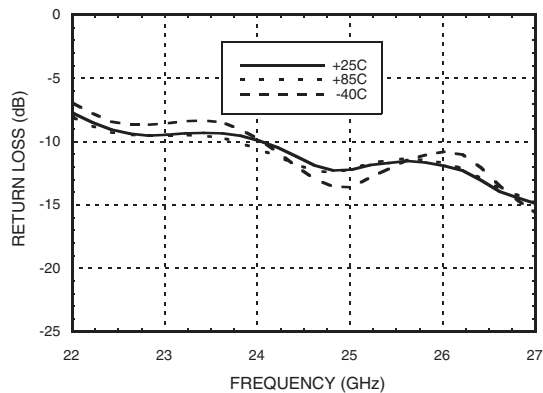

Output Return Loss vs. Temperature

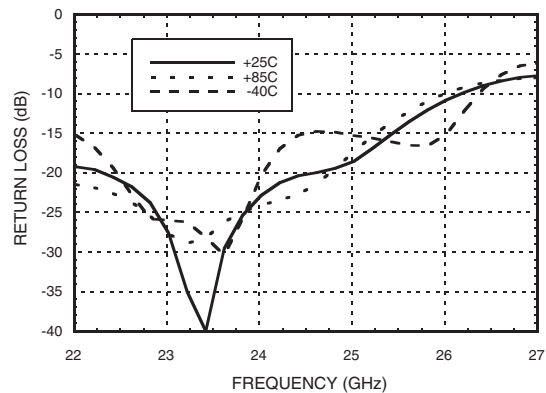

P1dB vs. Temperature

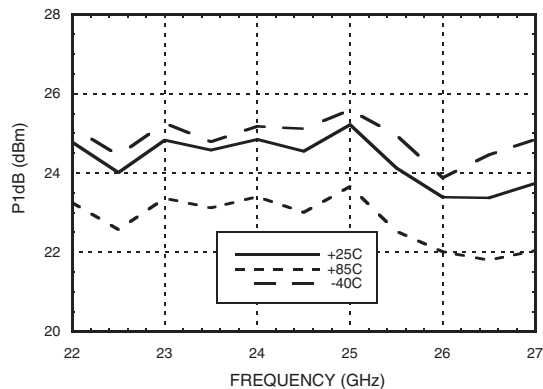

P1dB vs. Supply Voltage

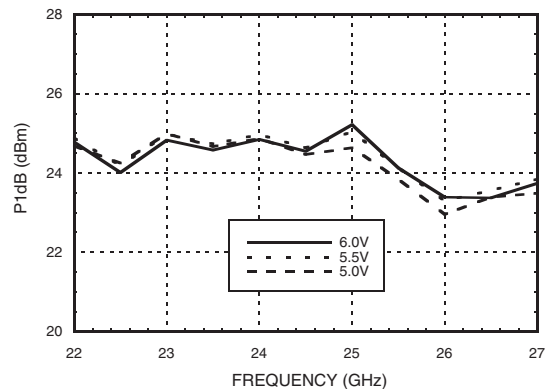

Information furnished by Analog Devices is believed to be accurate and reliable. However, no responsibility is assumed by Analog Devices for its use, nor for any infringements of patents or other rights of third parties that may result from its use. Specifications subject to change without notice. No license is granted by implication or otherwise under any patent or patent rights of Analog Devices. Trademarks and registered trademarks are the property of their respective owners.

For price, delivery, and to place orders: Analog Devices, Inc., One Technology Way, P.O. Box 9106, Norwood, MA 02062-9106 Phone: 781-329-4700 • Order online at www.analog.com Application Support: Phone: 1-800-ANALOG-D



**GaAs pHEMT MMIC 1/2 WATT
POWER AMPLIFIER, 22 - 26.5 GHz**

Psat vs. Temperature

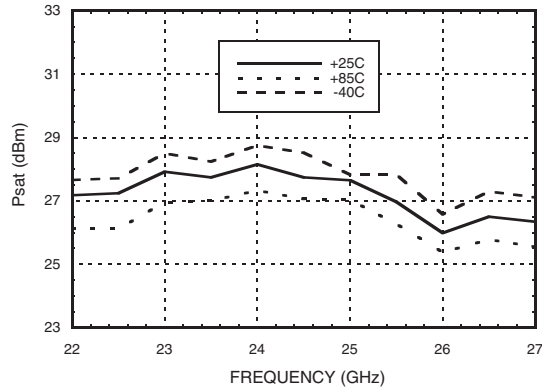

Psat vs. Supply Voltage

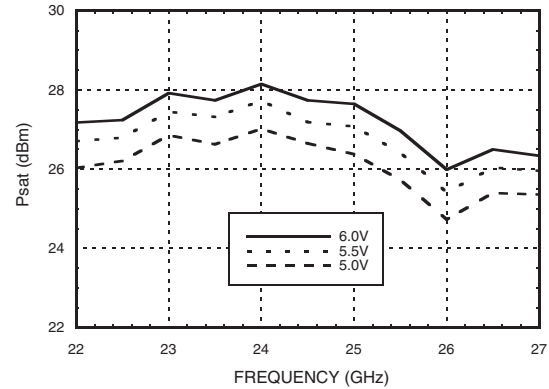

P1dB vs. Supply Current (Idd)

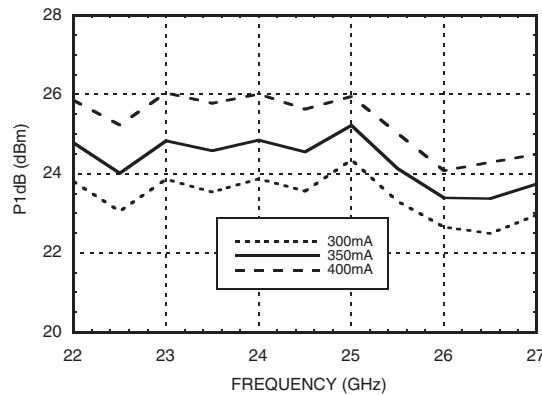

Psat vs. Supply Current (Idd)

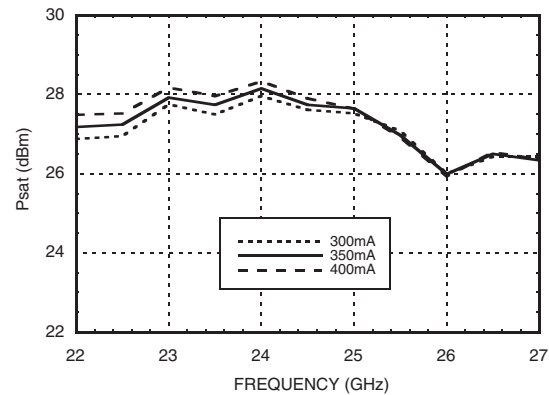

Output IP3 vs. Temperature, Pout/Tone = +14 dBm

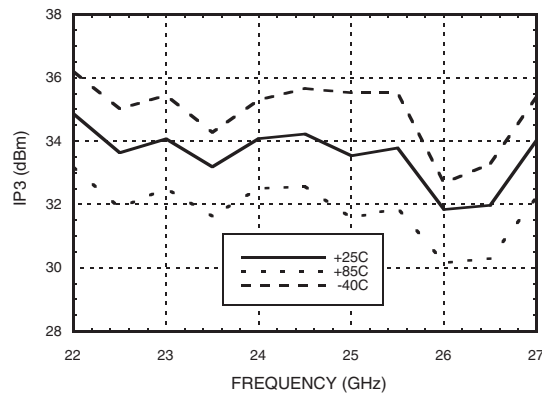

Output IP3 vs. Supply Current, Pout/Tone = +14 dBm

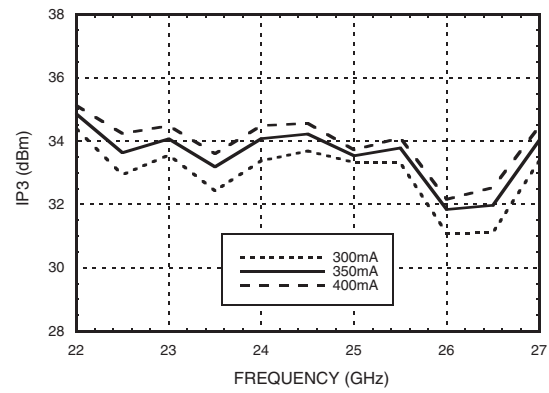

Information furnished by Analog Devices is believed to be accurate and reliable. However, no responsibility is assumed by Analog Devices for its use, nor for any infringements of patents or other rights of third parties that may result from its use. Specifications subject to change without notice. No license is granted by implication or otherwise under any patent or patent rights of Analog Devices. Trademarks and registered trademarks are the property of their respective owners.

For price, delivery, and to place orders: Analog Devices, Inc., One Technology Way, P.O. Box 9106, Norwood, MA 02062-9106 Phone: 781-329-4700 • Order online at www.analog.com Application Support: Phone: 1-800-ANALOG-D



GaAs pHEMT MMIC 1/2 WATT POWER AMPLIFIER, 22 - 26.5 GHz

Output IP3 vs. Supply Voltage, Pout/Tone = +14 dBm

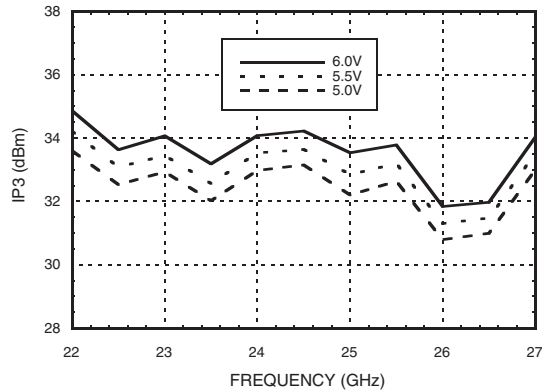

Output IM3 @ Vdd = +5V

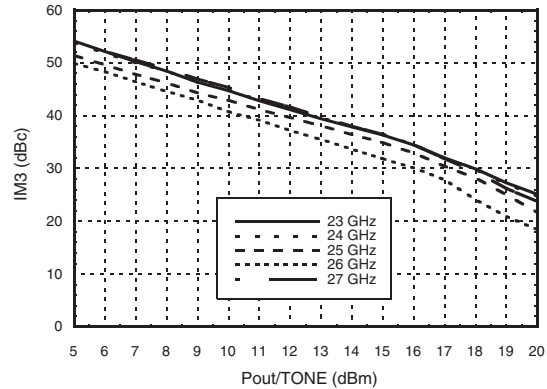

Output IM3 @ Vdd = +5.5V

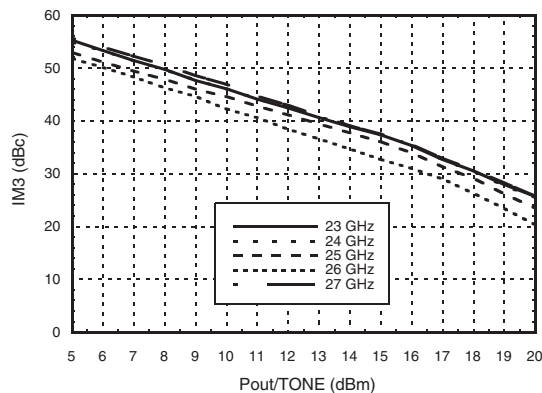

Output IM3 @ Vdd = +6V

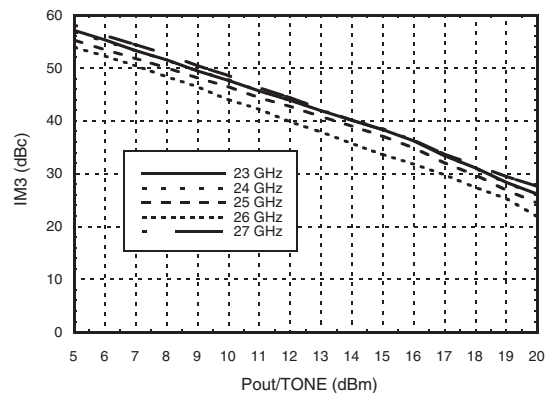

Power Compression @ 25 GHz

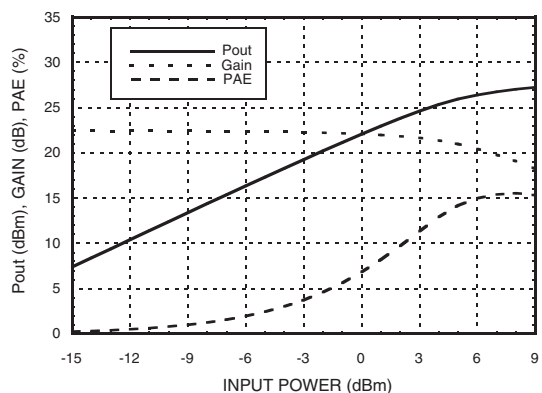

Reverse Isolation vs. Temperature

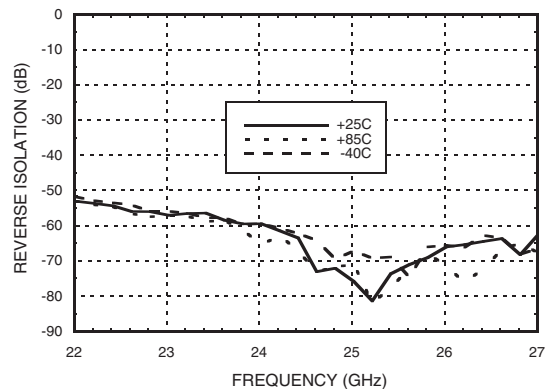

Information furnished by Analog Devices is believed to be accurate and reliable. However, no responsibility is assumed by Analog Devices for its use, nor for any infringements of patents or other rights of third parties that may result from its use. Specifications subject to change without notice. No license is granted by implication or otherwise under any patent or patent rights of Analog Devices. Trademarks and registered trademarks are the property of their respective owners.

For price, delivery, and to place orders: Analog Devices, Inc., One Technology Way, P.O. Box 9106, Norwood, MA 02062-9106 Phone: 781-329-4700 • Order online at www.analog.com Application Support: Phone: 1-800-ANALOG-D



GaAs pHEMT MMIC 1/2 WATT POWER AMPLIFIER, 22 - 26.5 GHz

**Gain & Power vs.
Supply Current @ 25 GHz**

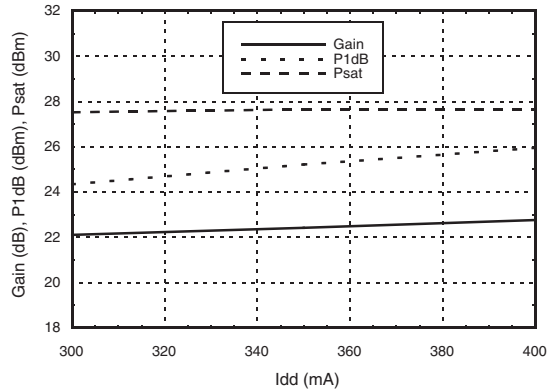

**Gain & Power vs.
Supply Voltage @ 25 GHz**

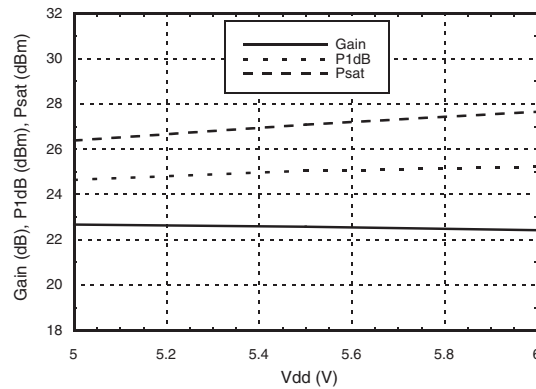

Power Dissipation

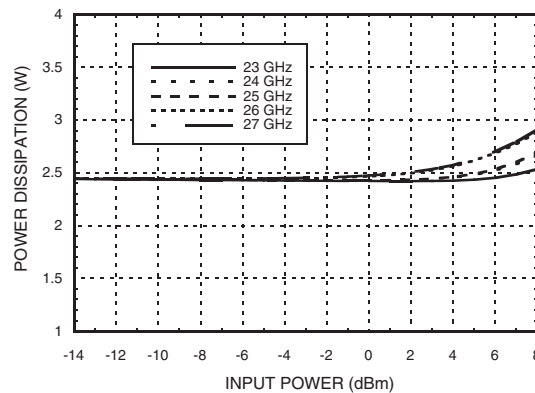

Absolute Maximum Ratings

Drain Bias Voltage (Vd)	6.3V
RF Input Power (RFIN)	+26 dBm
Channel Temperature	150 °C
Continuous Pdiss (T= 85 °C) (derate 37 mW/°C above 85 °C)	2.52 W
Thermal Resistance (channel to ground paddle)	26.9 C/W
Storage Temperature	-65 to +150 °C
Operating Temperature	-55 to +85 °C
ESD Sensitivity (HBM)	Class 0, 150V

Typical Supply Current vs. Vdd

Vdd (V)	Idd (mA)
+5.0	350
+5.5	350
+6.0	350

Note: Amplifier will operate over full voltage ranges shown above Vgg adjusted to achieve Idd = 350mA at +5.5V



**ELECTROSTATIC SENSITIVE DEVICE
OBSERVE HANDLING PRECAUTIONS**

GaAs pHEMT MMIC ½ WATT POWER AMPLIFIER, 22 - 26.5 GHz



Outline Drawing

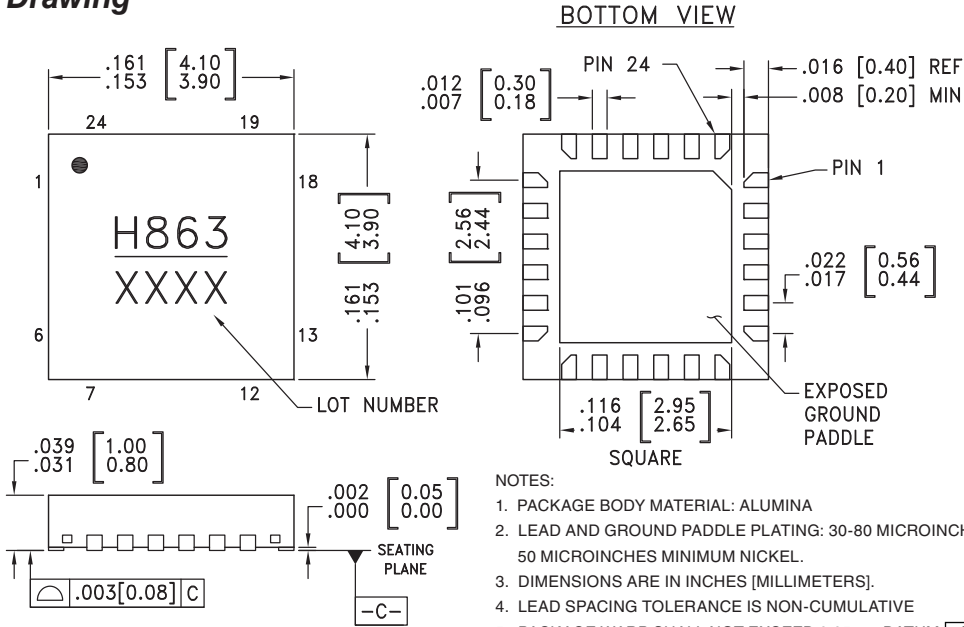

Package Information

Part Number	Package Body Material	Lead Finish	MSL Rating	Package Marking ^[1]
HMC863LP4E	RoHS-compliant Low Stress Injection Molded Plastic	100% matte Sn	MSL1 ^[2]	H863 XXXX

[1] 4-Digit lot number XXXX

[2] Max peak reflow temperature of 260 °C

Pin Descriptions

Pin Number	Function	Description	Interface Schematic
1, 2, 4 - 7, 12 - 15, 17 - 19, 24 Package Bottom	GND	Ground pins and package bottom must be connected to RF/DC ground.	
3	RFIN	This pin is AC coupled and matched to 50 Ohms.	
8 - 11	N/C	The pins are not connected internally; however, all data shown herein was measured with these pins connected to RF/DC ground externally.	
16	RFOUT	This pin is AC coupled and matched to 50 Ohms.	
20	Vd	Drain bias for amplifier. External 100 pF, 0.1 μF and 4.7 μF bypass capacitors are required.	
23	Vg	Gate control for PA. Adjust Vg to achieve recommended bias current. External 100 pF, 0.1 μF and 4.7 μF bypass capacitors are required.	

Information furnished by Analog Devices is believed to be accurate and reliable. However, no responsibility is assumed by Analog Devices for its use, nor for any infringements of patents or other rights of third parties that may result from its use. Specifications subject to change without notice. No license is granted by implication or otherwise under any patent or patent rights of Analog Devices. Trademarks and registered trademarks are the property of their respective owners.

For price, delivery, and to place orders: Analog Devices, Inc., One Technology Way, P.O. Box 9106, Norwood, MA 02062-9106
Phone: 781-329-4700 • Order online at www.analog.com
Application Support: Phone: 1-800-ANALOG-D

**GaAs pHEMT MMIC ½ WATT
POWER AMPLIFIER, 22 - 26.5 GHz**



Evaluation PCB

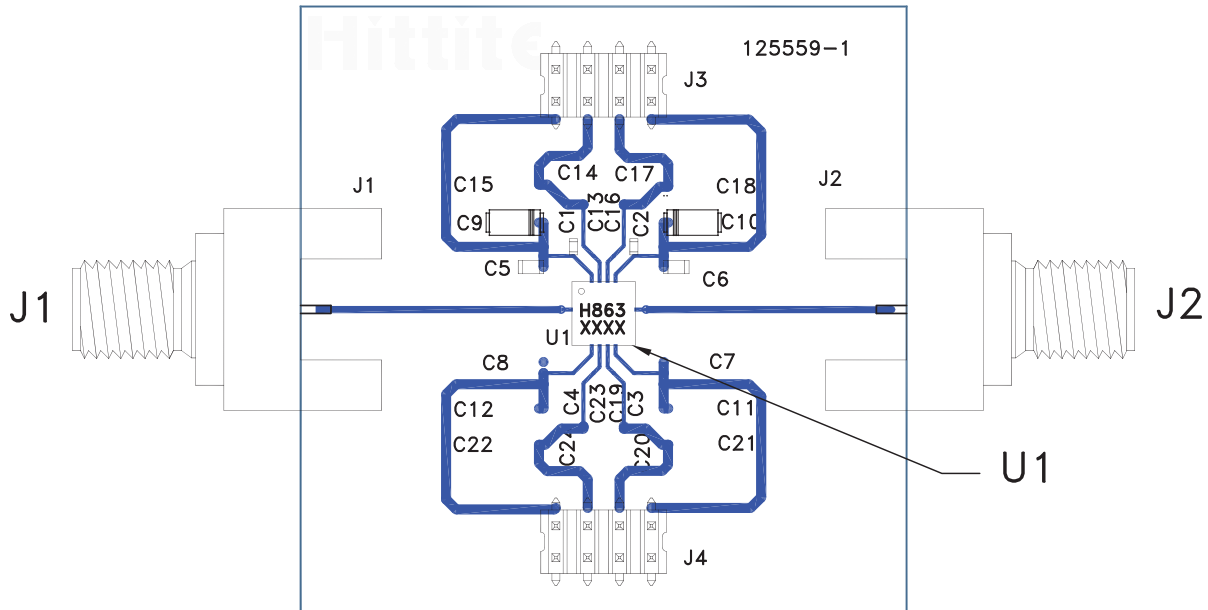

List of Materials for Evaluation PCB 130560 [1]

Item	Description
J1 - J2	2.9 mm Connectors
J3 - J4	DC Pins
C1, C2	100 pF Capacitors, 0402 Pkg.
C6	10 kΩ Resistor, 0402 Pkg
C10	4.7 μF Capacitor, 0402 Pkg.
U1	HMC863LP4E Power Amplifier
PCB [2]	125559 Evaluation PCB

[1] Reference this number when ordering complete evaluation PCB

[2] Circuit Board Material: Rogers 4350 or Arlon FR4

The circuit board used in the application should use RF circuit design techniques. Signal lines should have 50 Ohm impedance while the package ground leads and exposed paddle should be connected directly to the ground plane similar to that shown. A sufficient number of via holes should be used to connect the top and bottom ground planes. The evaluation board should be mounted to an appropriate heat sink. The evaluation circuit board shown is available from Hittite upon request.

**GaAs pHEMT MMIC ½ WATT
POWER AMPLIFIER, 22 - 26.5 GHz**



Application Circuit

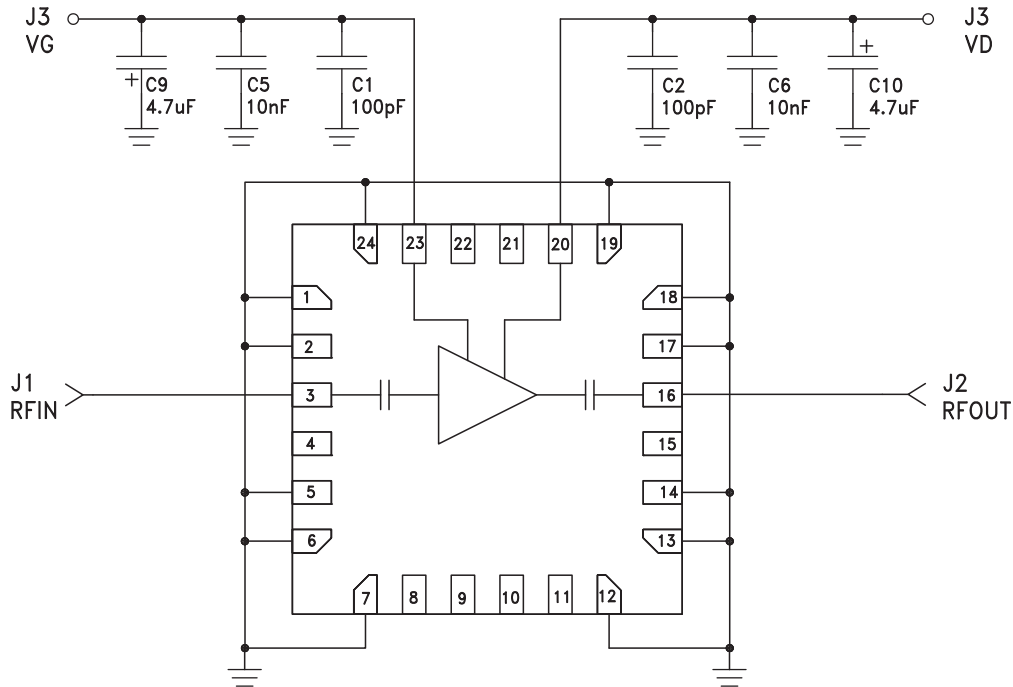

Information furnished by Analog Devices is believed to be accurate and reliable. However, no responsibility is assumed by Analog Devices for its use, nor for any infringements of patents or other rights of third parties that may result from its use. Specifications subject to change without notice. No license is granted by implication or otherwise under any patent or patent rights of Analog Devices. Trademarks and registered trademarks are the property of their respective owners.

For price, delivery, and to place orders: Analog Devices, Inc., One Technology Way, P.O. Box 9106, Norwood, MA 02062-9106 Phone: 781-329-4700 • Order online at www.analog.com Application Support: Phone: 1-800-ANALOG-D