



Chipsmall Limited consists of a professional team with an average of over 10 year of expertise in the distribution of electronic components. Based in Hongkong, we have already established firm and mutual-benefit business relationships with customers from,Europe,America and south Asia,supplying obsolete and hard-to-find components to meet their specific needs.

With the principle of “Quality Parts,Customers Priority,Honest Operation,and Considerate Service”,our business mainly focus on the distribution of electronic components. Line cards we deal with include Microchip,ALPS,ROHM,Xilinx,Pulse,ON,Everlight and Freescale. Main products comprise IC,Modules,Potentiometer,IC Socket,Relay,Connector.Our parts cover such applications as commercial,industrial, and automotives areas.

We are looking forward to setting up business relationship with you and hope to provide you with the best service and solution. Let us make a better world for our industry!



## Contact us

Tel: +86-755-8981 8866 Fax: +86-755-8427 6832

Email & Skype: info@chipsmall.com Web: www.chipsmall.com

Address: A1208, Overseas Decoration Building, #122 Zhenhua RD., Futian, Shenzhen, China



## FILTER - TUNABLE, BAND PASS SMT 11.5 - 21.5 GHz



### Typical Applications

The HMC898LP4E is ideal for:

- Test & Measurement Equipment
- Military RADAR & EW/ECM
- SATCOM & Space
- Industrial & Medical Equipment

### Functional Diagram

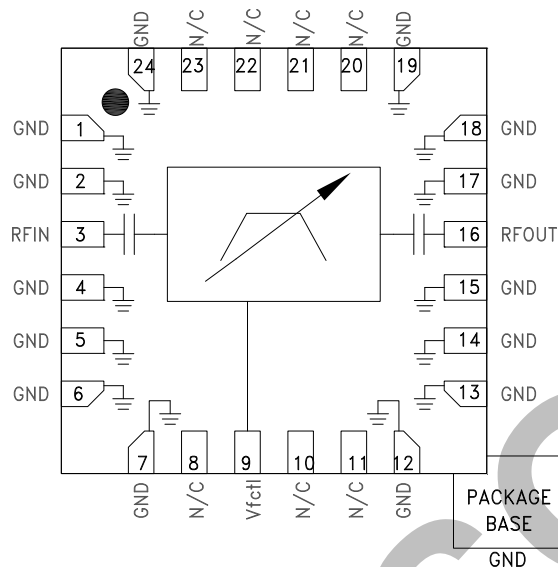

### Features

- Fast Tuning Response
- Excellent Wideband Rejection
- Single Chip Replacement for Mechanically Tuned Designs
- 24 Lead 4x4 mm SMT Package

### General Description

The HMC898LP4E is a MMIC band pass filter which features a user selectable passband frequency. The 3 dB filter bandwidth is approximately 17%. The 20 dB filter bandwidth is approximately 35%. The center frequency can be varied between 11.5 and 21.5 GHz by applying an analog tune voltage between 0 and 14V. This tunable filter can be used as a much smaller alternative to physically large switched filter banks and cavity tuned filters. The HMC898LP4E has excellent microphonics due to the monolithic design, and provides a dynamically adjustable solution in advanced communications applications.

### Electrical Specifications, $T_A = +25^\circ\text{C}$

Parameter	Min.	Typ.	Max.	Units
$F_{\text{center}}$ Tuning Range	11.5		21.5	GHz
3 dB Bandwidth		17		%
Low Side Rejection Frequency (Rejection >20 dB)		$0.81 * F_{\text{center}}$		GHz
High Side Rejection Frequency (Rejection >20 dB)		$1.16 * F_{\text{center}}$		GHz
Low Side Sub-Harmonic Rejection (Rejection >40 dB)		$0.55 * F_{\text{center}}$		GHz
High Side Sub-Harmonic Rejection (Rejection >40 dB)		$1.27 * F_{\text{center}}$		GHz
Re-entry Frequency (Rejection <30 dB)		>40		GHz
Insertion Loss		6		dB
Return Loss (2 dB Bandwidth)		9		dB
Input IP3 (Pin = 0 to +15 dBm)		29		dBm
Input Power @ 5° Shift In Insertion Phase ( $V_{\text{fctl}} = 0\text{V}$ )		9		dBm
Input Power @ 5° Shift In Insertion Phase ( $V_{\text{fctl}} = 1\text{V}$ )		14		dBm
Frequency Control Voltage ( $V_{\text{fctl}}$ )	0		14	V
Source/Sink Current ( $I_{\text{fctl}}$ )			±1	mA
Residual Phase Noise <sup>[1]</sup> (100 kHz Offset)		-157		dBc/Hz
$F_{\text{center}}$ Drift Rate		-1.9		MHz/°C
Tuning Speed, Phase Settling to within 10° <sup>[2]</sup>		< 200		ns

[1] Optimum residual phase noise performance requires the use of a low noise driver circuit.

[2] Tuning speed includes 40 ns tuning voltage ramp from driver.



**FILTER - TUNABLE, BAND PASS SMT  
11.5 - 21.5 GHz**

**Broadband Insertion Loss vs. Vfctl**

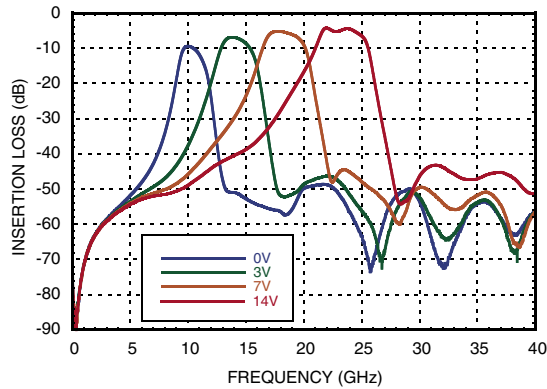

**Broadband Return Loss vs. Vfctl**

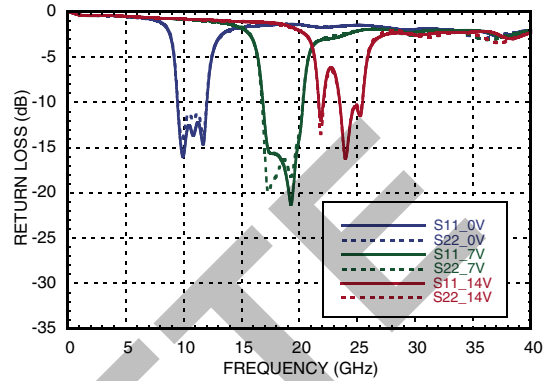

**Insertion Loss vs. Vfctl**

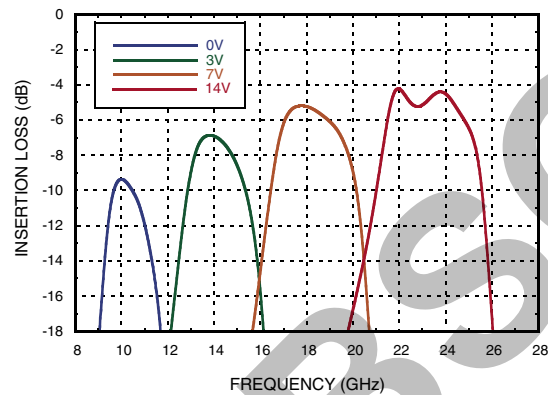

**Return Loss vs. Vfctl**

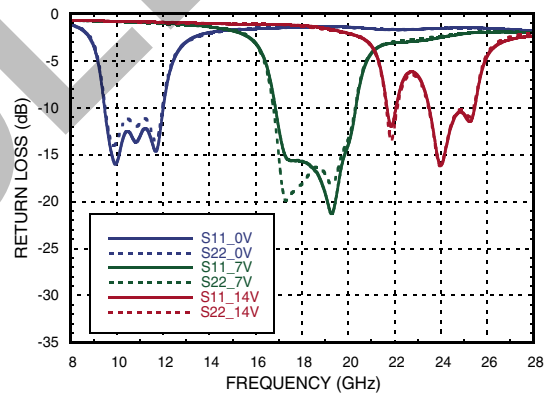

**Insertion Loss vs. Temperature, Vfctl = 7V**

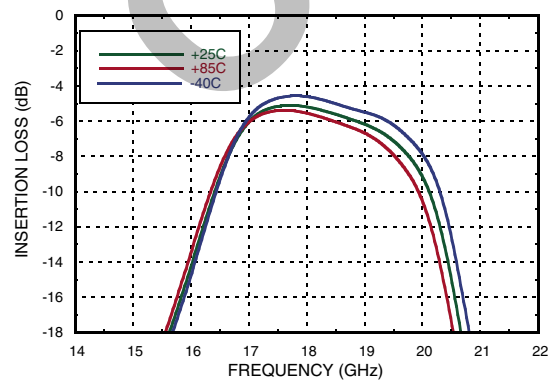

**Return Loss vs. Temperature, Vfctl = 7V**

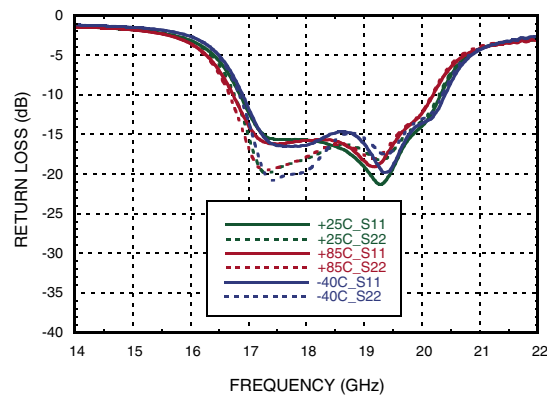

Information furnished by Analog Devices is believed to be accurate and reliable. However, no responsibility is assumed by Analog Devices for its use, nor for any infringements of patents or other rights of third parties that may result from its use. Specifications subject to change without notice. No license is granted by implication or otherwise under any patent or patent rights of Analog Devices. Trademarks and registered trademarks are the property of their respective owners.

For price, delivery, and to place orders: Analog Devices, Inc., One Technology Way, P.O. Box 9106, Norwood, MA 02062-9106 Phone: 781-329-4700 • Order online at [www.analog.com](http://www.analog.com) Application Support: Phone: 1-800-ANALOG-D



**FILTER - TUNABLE, BAND PASS SMT  
11.5 - 21.5 GHz**

**Center Frequency vs. Temperature**

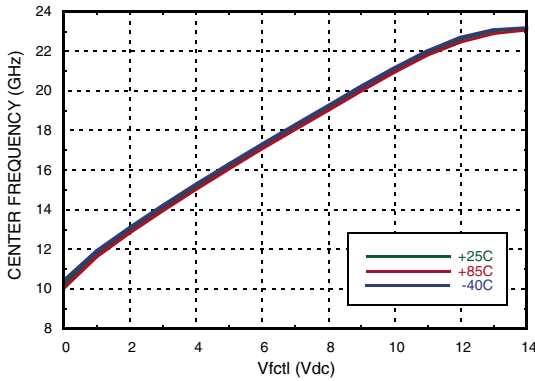

**Insertion Loss vs. Temperature**

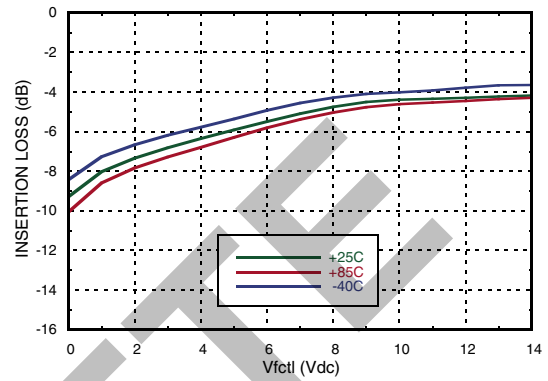

**3 dB Bandwidth vs. Temperature**

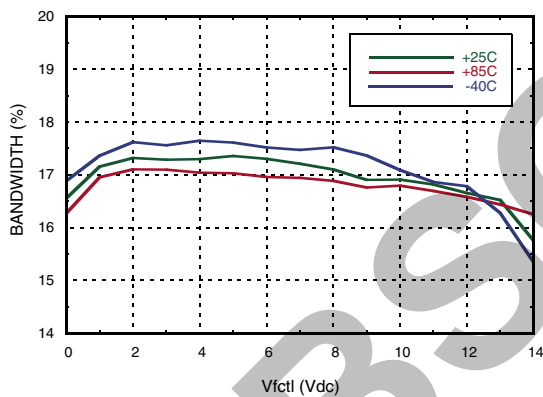

**Return Loss in a 2 dB Bandwidth vs. Temperature**

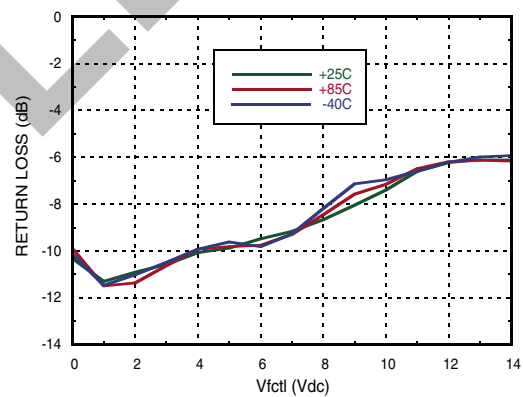

**Low Side Rejection Ratio vs. Temperature [1]**

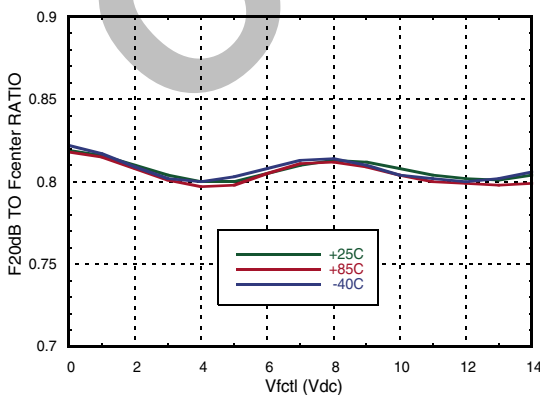

**High Side Rejection Ratio vs. Temperature [1]**

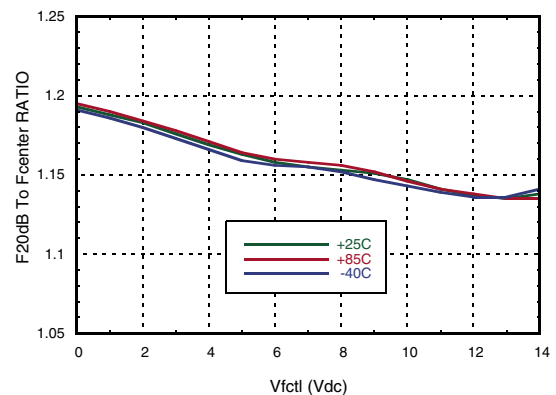

[1] Rejection ratio is defined as the ratio of the frequency at which the relative insertion loss is 20 dB to fcenter

**FILTER - TUNABLE, BAND PASS SMT  
11.5 - 21.5 GHz**



**Tuning Sensitivity vs. Temperature**

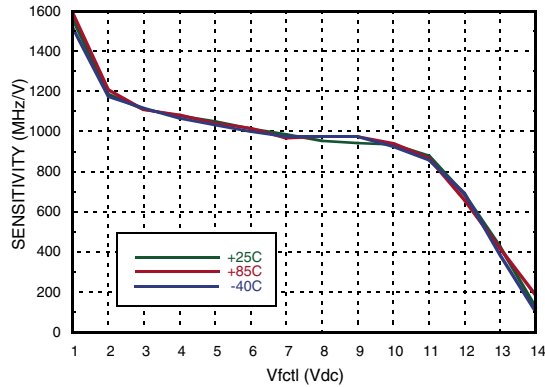

**Group Delay vs. Frequency**

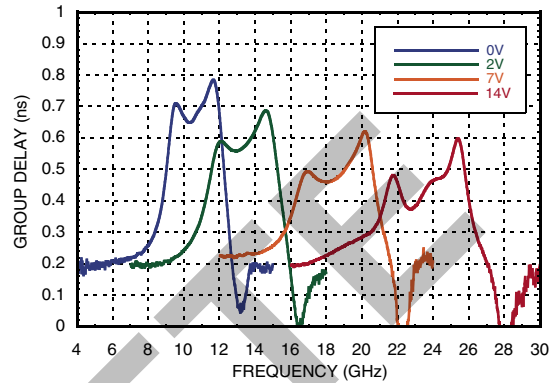

**Group Delay vs. Fcenter vs. Temperature**

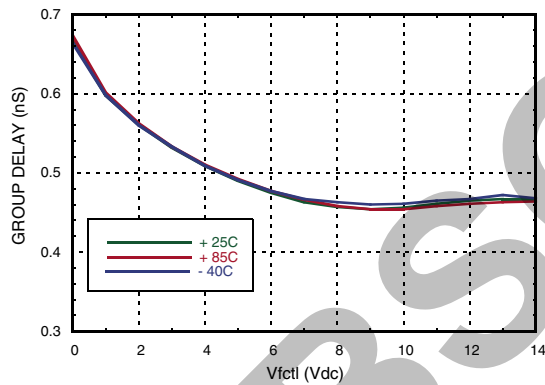

**Input IP3 vs. Temperature**

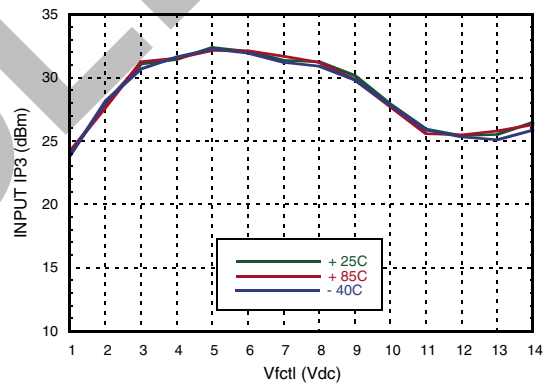

**Residual Phase Noise**

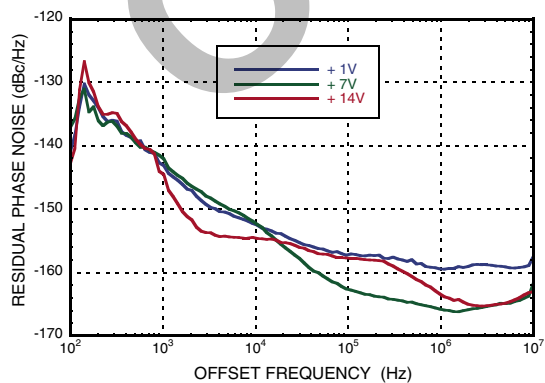

**Phase Sensitivity vs. Vctrl**

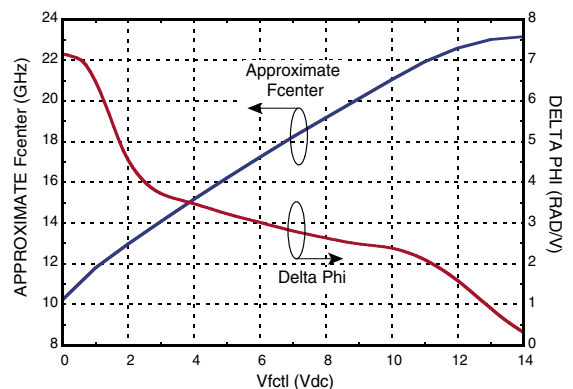

Information furnished by Analog Devices is believed to be accurate and reliable. However, no responsibility is assumed by Analog Devices for its use, nor for any infringements of patents or other rights of third parties that may result from its use. Specifications subject to change without notice. No license is granted by implication or otherwise under any patent or patent rights of Analog Devices. Trademarks and registered trademarks are the property of their respective owners.

For price, delivery, and to place orders: Analog Devices, Inc., One Technology Way, P.O. Box 9106, Norwood, MA 02062-9106 Phone: 781-329-4700 • Order online at [www.analog.com](http://www.analog.com) Application Support: Phone: 1-800-ANALOG-D



**FILTER - TUNABLE, BAND PASS SMT  
11.5 - 21.5 GHz**

**Insertion Phase vs. Input Power**

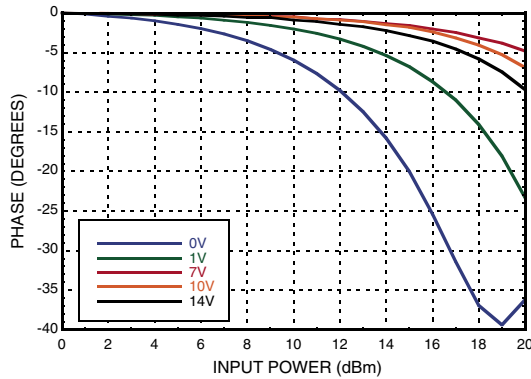

**Fcenter vs. Input Power**

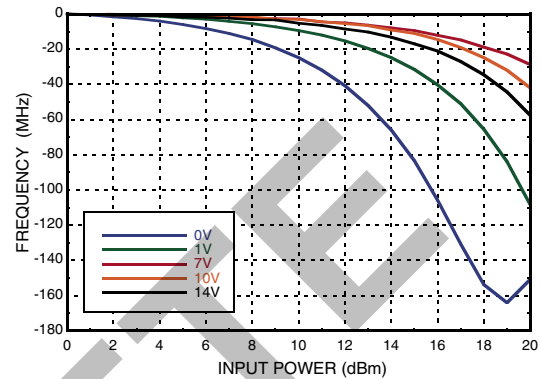

**Absolute Maximum Ratings**

Frequency Control Voltage (Vfctl)	-0.5 to +15V
RF Power Input	27 dBm
Storage Temperature	-65 to +150 °C
ESD Sensitivity (HBM)	Class 1 A

**Reliability Information**

Junction Temperature to Maintain 1 Million Hour MTTF	150 °C
Nominal Junction Temperature (T= 85 °C and Pin = 27 dBm)	103 °C
Operating Temperature	-40 to +85 °C



**ELECTROSTATIC SENSITIVE DEVICE  
OBSERVE HANDLING PRECAUTIONS**

## FILTER - TUNABLE, BAND PASS SMT 11.5 - 21.5 GHz



### Outline Drawing

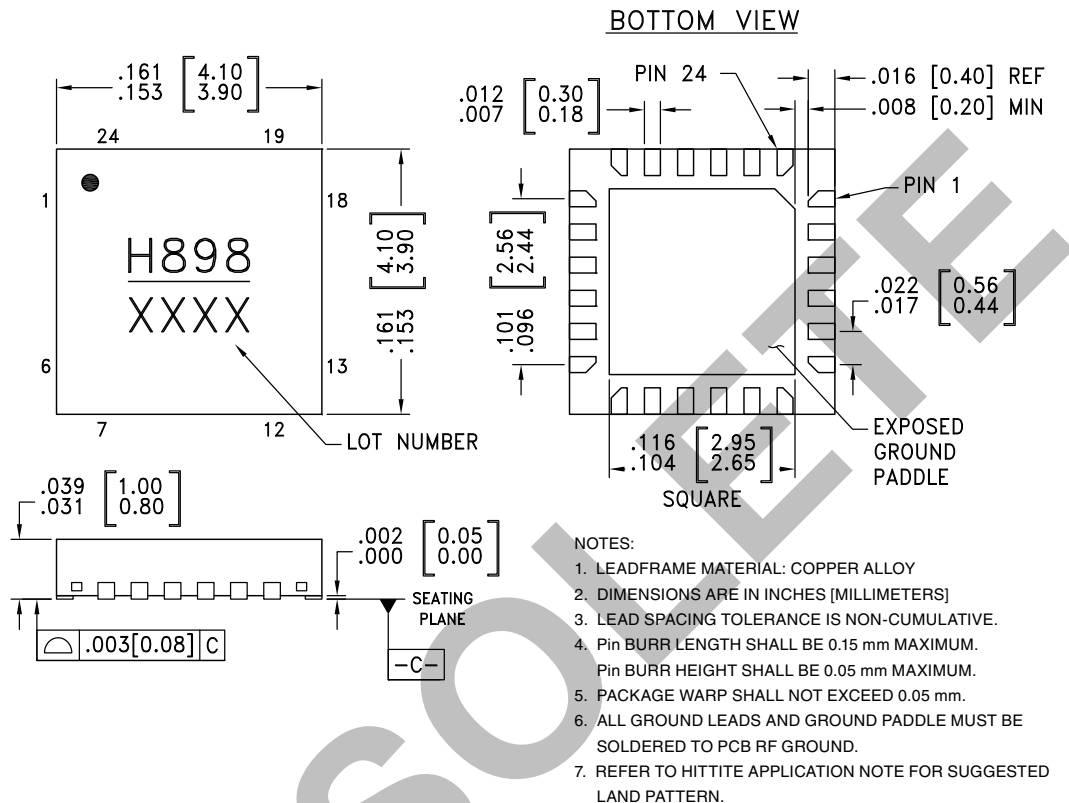

### Package Information

Part Number	Package Body Material	Lead Finish	MSL Rating	Package Marking <sup>[1]</sup>
HMC898LP4E	RoHS-compliant Low Stress Injection Molded Plastic	100% matte Sn	MSL1 <sup>[2]</sup>	H898 XXXX

[1] 4-Digit lot number XXXX

[2] Max peak reflow temperature of 260 °C



**FILTER - TUNABLE, BAND PASS SMT**  
**11.5 - 21.5 GHz**

**Pin Descriptions**

Pin Number	Function	Description	Interface Schematic
1, 2, 4 - 7, 12 - 15, 17 - 19, 24	GND	These pins and exposed paddle must be connected to RF/DC ground.	
8, 10, 11, 20 - 23	NC	The pins are not connected internally; however, all data shown herein was measured with these pins connected to RF/DC ground externally.	
3	RFIN	This pin is AC coupled and matched to 50 Ohms.	
9	Vfctl	Center frequency control voltage.	
16	RFOUT	This pin is AC coupled and matched to 50 Ohms.	

**Application Circuit**

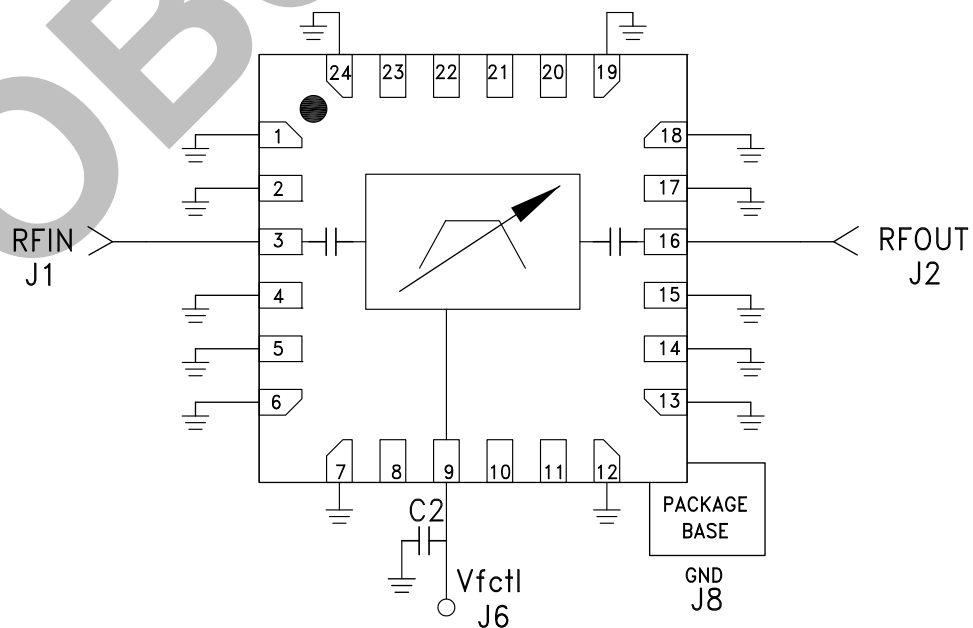

Information furnished by Analog Devices is believed to be accurate and reliable. However, no responsibility is assumed by Analog Devices for its use, nor for any infringements of patents or other rights of third parties that may result from its use. Specifications subject to change without notice. No license is granted by implication or otherwise under any patent or patent rights of Analog Devices. Trademarks and registered trademarks are the property of their respective owners.

For price, delivery, and to place orders: Analog Devices, Inc., One Technology Way, P.O. Box 9106, Norwood, MA 02062-9106 Phone: 781-329-4700 • Order online at [www.analog.com](http://www.analog.com) Application Support: Phone: 1-800-ANALOG-D

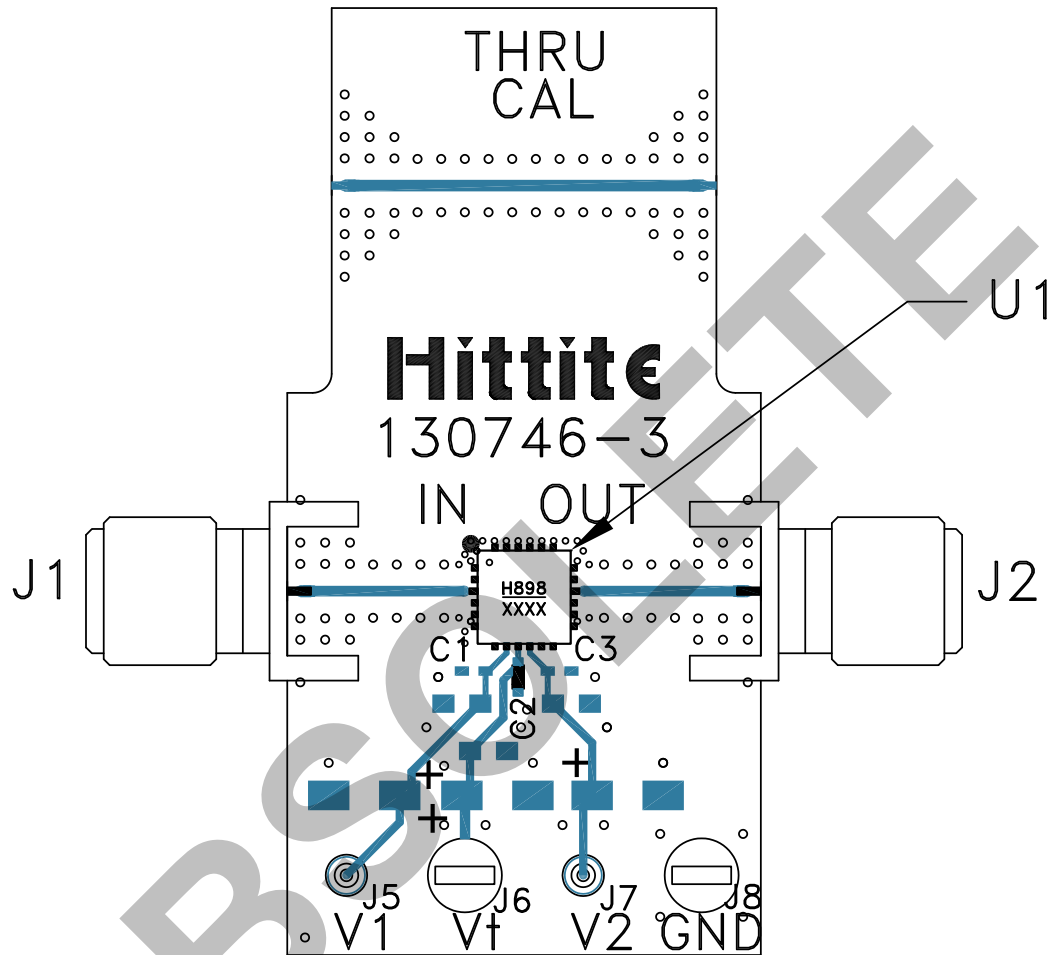

**Evaluation PCB**

**List of Materials for Evaluation PCB 131086 [1]**

Item	Description
J1, J2	Connector, 2.9 mm, Female
J6, J8	DC Pin
C2	100 pF Capacitor, 0402 Pkg.
U1	HMC898LP4E Filter - Tunable
PCB [2]	130746 Evaluation PCB

[1] Reference this number when ordering complete evaluation PCB

[2] Circuit Board Material: Arlon 25FR or Rogers 25FR

The circuit board used in the application should use RF circuit design techniques. Signal lines should have 50 Ohms impedance while the package ground leads and exposed paddle should be connected directly to the ground plane similar to that shown. A sufficient number of via holes should be used to connect the top and bottom ground planes. The evaluation circuit board shown is available from Hittite upon request.