



Chipsmall Limited consists of a professional team with an average of over 10 year of expertise in the distribution of electronic components. Based in Hongkong, we have already established firm and mutual-benefit business relationships with customers from,Europe,America and south Asia,supplying obsolete and hard-to-find components to meet their specific needs.

With the principle of “Quality Parts,Customers Priority,Honest Operation,and Considerate Service”,our business mainly focus on the distribution of electronic components. Line cards we deal with include Microchip,ALPS,ROHM,Xilinx,Pulse,ON,Everlight and Freescale. Main products comprise IC,Modules,Potentiometer,IC Socket,Relay,Connector.Our parts cover such applications as commercial,industrial, and automotives areas.

We are looking forward to setting up business relationship with you and hope to provide you with the best service and solution. Let us make a better world for our industry!



## Contact us

Tel: +86-755-8981 8866 Fax: +86-755-8427 6832

Email & Skype: info@chipsmall.com Web: www.chipsmall.com

Address: A1208, Overseas Decoration Building, #122 Zhenhua RD., Futian, Shenzhen, China





## GaAs pHEMT MMIC 2 WATT POWER AMPLIFIER, 27.3 - 33.5 GHz

### Typical Applications

The HMC906 is ideal for:

- Point-to-Point Radios
- Point-to-Multi-Point Radios
- VSAT
- Military & Space

### Features

- Saturated Output Power: +34 dBm @ 22% PAE
- High Output IP3: +43 dBm
- High Gain: 23 dB
- DC Supply: +6V @ 1200 mA
- No External Matching Required
- Die Size: 3.18 x 2.73 x 0.1 mm

### Functional Diagram

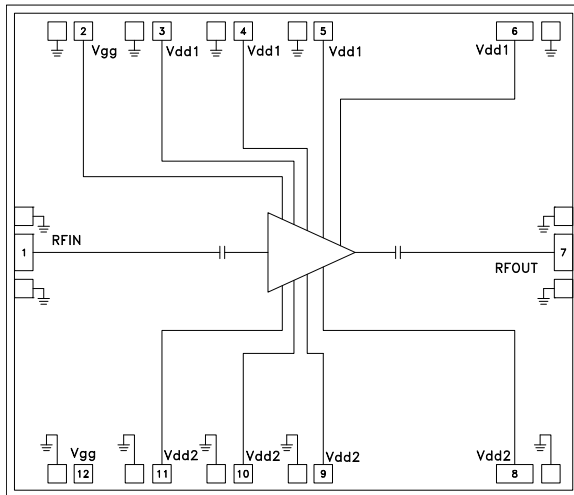

### General Description

The HMC906 is a four stage GaAs pHEMT MMIC 2 Watt Power Amplifier which operates between 27.3 and 33.5 GHz. The HMC906 provides 23 dB of gain, and +34 dBm of saturated output power and 22% PAE from a +6V supply. The RF I/Os are DC blocked and matched to 50 Ohms for ease of integration into Multi-Chip-Modules (MCMs). All data is taken with the chip in a 50 Ohm test fixture connected via two 0.025 mm (1 mil) diameter wire bonds of length 0.31 mm (12 mils).

### Electrical Specifications, $T_A = +25^\circ\text{C}$ , $V_{dd1} = V_{dd2} = +6\text{V}$ , $I_{dd} = 1200\text{mA}$ [1]

Parameter	Min.	Typ.	Max.	Min.	Typ.	Max.	Units
Frequency Range	27.3 - 31.5		31.5 - 33.5				GHz
Gain	20	23		20	23		dB
Gain Variation Over Temperature		0.022			0.026		dB/°C
Input Return Loss	10	14		10	14		dB
Output Return Loss	8	12		10	12		dB
Output Power for 1 dB Compression (P1dB)	31	33		30.5	32.5		dBm
Saturated Output Power (P <sub>sat</sub> )		34			33.5		dBm
Output Third Order Intercept (IP3) <sup>[2]</sup>	40	43		39	42		dBm
Total Supply Current (I <sub>dd</sub> )		1200			1200		mA

[1] Adjust V<sub>gg</sub> (pad 2 or 12) between -2 to 0V to achieve I<sub>dd</sub> = 1200 mA typical.

[2] Measurement taken at +6V @ 1200 mA, P<sub>out</sub> / Tone = +23 dBm



**GaAs pHEMT MMIC 2 WATT  
POWER AMPLIFIER, 27.3 - 33.5 GHz**

**Broadband Gain &  
Return Loss vs. Frequency**

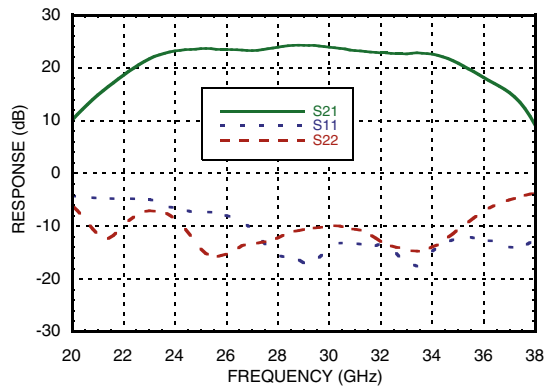

**Gain vs. Temperature**

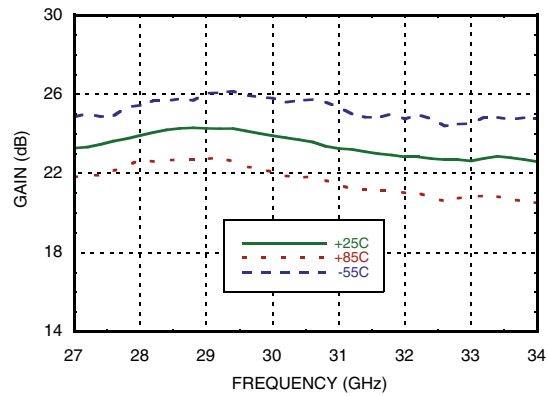

**Input Return Loss vs. Temperature**

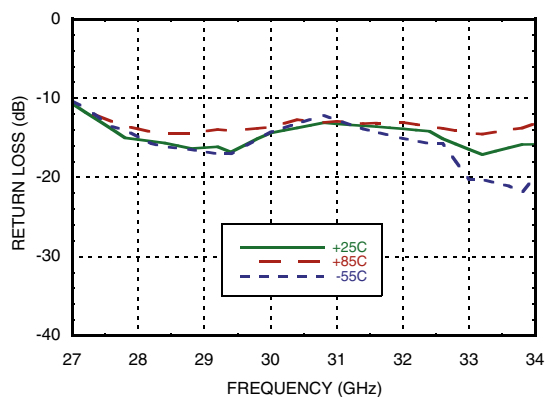

**Output Return Loss vs. Temperature**

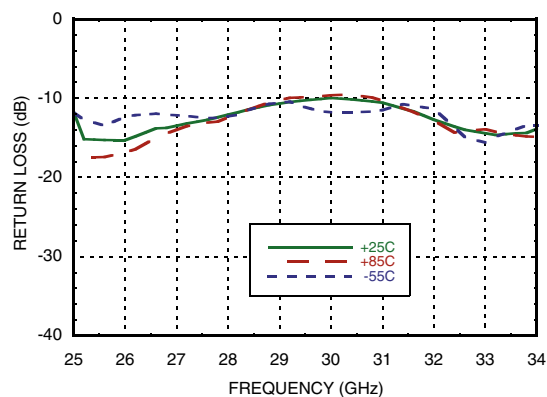

**P1dB vs. Temperature**

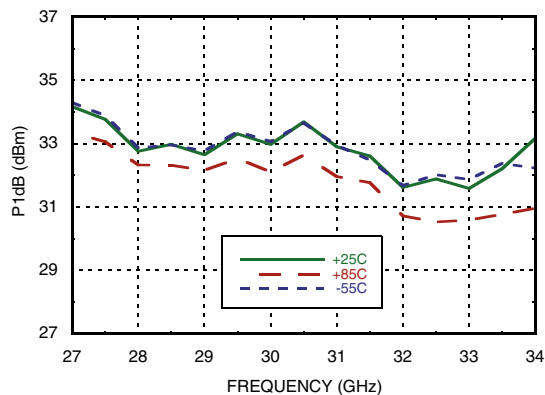

**P1dB vs. Supply Voltage**

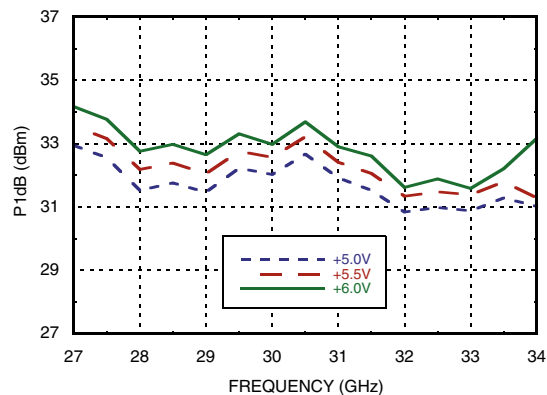

Information furnished by Analog Devices is believed to be accurate and reliable. However, no responsibility is assumed by Analog Devices for its use, nor for any infringements of patents or other rights of third parties that may result from its use. Specifications subject to change without notice. No license is granted by implication or otherwise under any patent or patent rights of Analog Devices. Trademarks and registered trademarks are the property of their respective owners.

For price, delivery, and to place orders: Analog Devices, Inc., One Technology Way, P.O. Box 9106, Norwood, MA 02062-9106 Phone: 781-329-4700 • Order online at [www.analog.com](http://www.analog.com) Application Support: Phone: 1-800-ANALOG-D



**GaAs pHEMT MMIC 2 WATT  
POWER AMPLIFIER, 27.3 - 33.5 GHz**

AMPLIFIERS - LINEAR & POWER - CHIP

**Psat vs. Temperature**

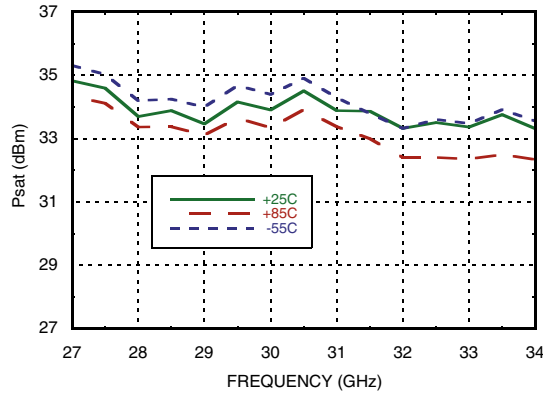

**Psat vs. Supply Voltage**

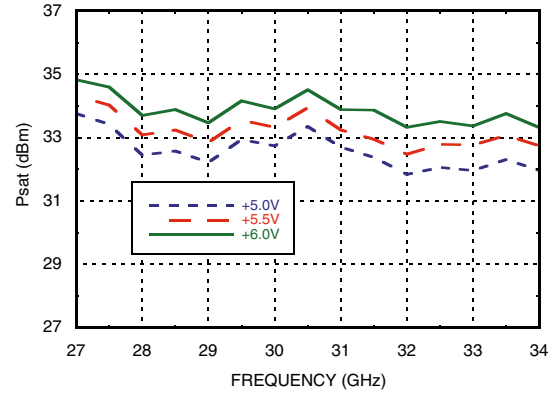

**P1dB vs. Supply Current (Idd)**

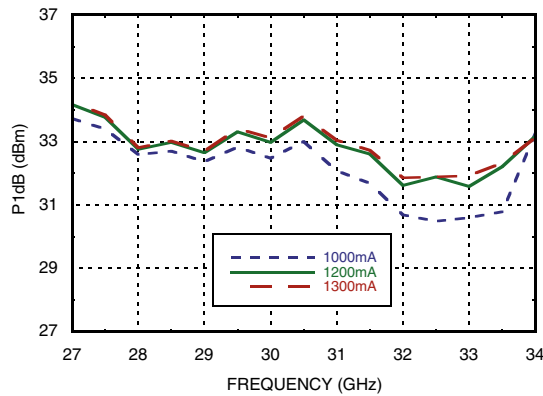

**Psat vs. Supply Current (Idd)**

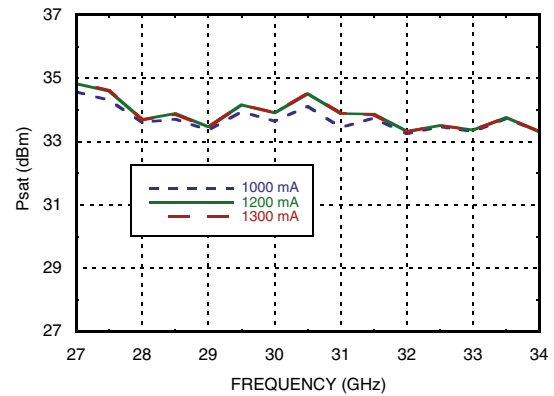

**Output IP3 vs. Temperature, Pout/Tone = +23 dBm**

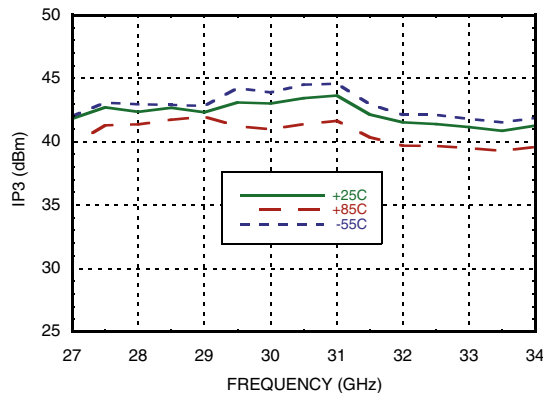

**Output IP3 vs. Supply Current, Pout/Tone = +23 dBm**

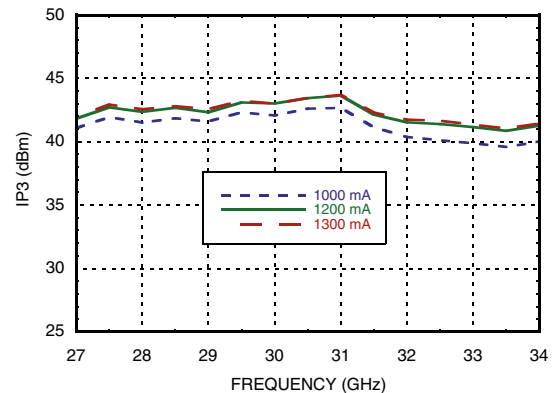

Information furnished by Analog Devices is believed to be accurate and reliable. However, no responsibility is assumed by Analog Devices for its use, nor for any infringements of patents or other rights of third parties that may result from its use. Specifications subject to change without notice. No license is granted by implication or otherwise under any patent or patent rights of Analog Devices. Trademarks and registered trademarks are the property of their respective owners.

For price, delivery, and to place orders: Analog Devices, Inc., One Technology Way, P.O. Box 9106, Norwood, MA 02062-9106 Phone: 781-329-4700 • Order online at [www.analog.com](http://www.analog.com) Application Support: Phone: 1-800-ANALOG-D



**GaAs pHEMT MMIC 2 WATT  
POWER AMPLIFIER, 27.3 - 33.5 GHz**

**Output IP3 vs.  
Supply Voltage, Pout/Tone = +23 dBm**

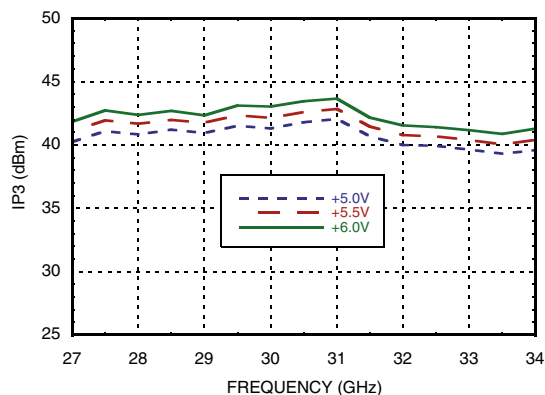

**Output IM3 @ Vdd = +5V**

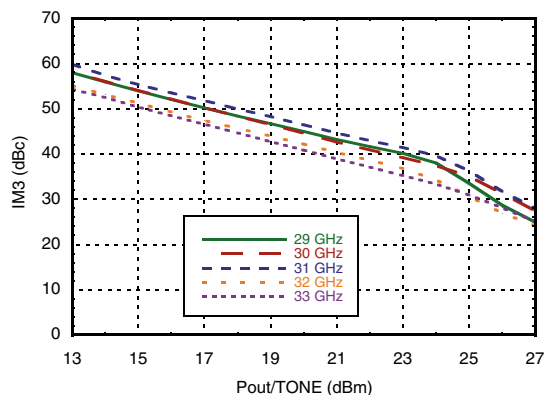

**Output IM3 @ Vdd = +5.5V**

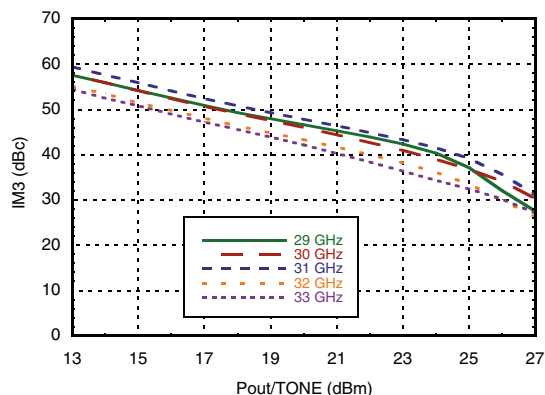

**Output IM3 @ Vdd = +6V**

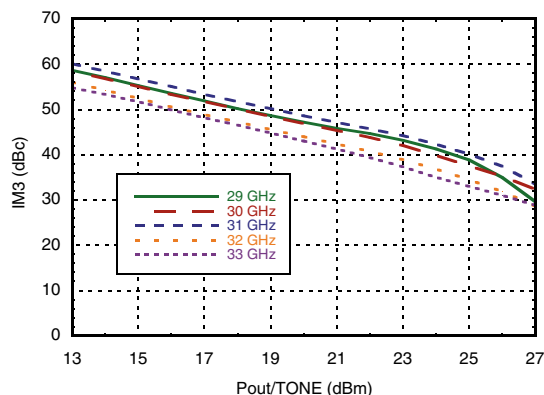

**Power Compression @ 29.5 GHz**

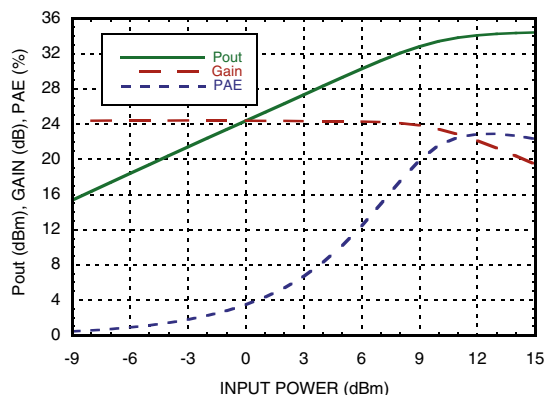

**Reverse Isolation vs. Temperature**

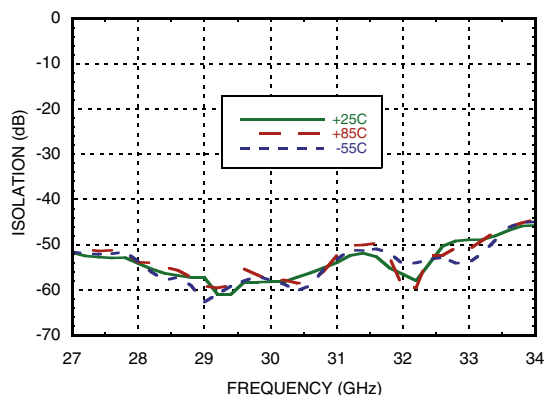

Information furnished by Analog Devices is believed to be accurate and reliable. However, no responsibility is assumed by Analog Devices for its use, nor for any infringements of patents or other rights of third parties that may result from its use. Specifications subject to change without notice. No license is granted by implication or otherwise under any patent or patent rights of Analog Devices. Trademarks and registered trademarks are the property of their respective owners.

For price, delivery, and to place orders: Analog Devices, Inc., One Technology Way, P.O. Box 9106, Norwood, MA 02062-9106 Phone: 781-329-4700 • Order online at [www.analog.com](http://www.analog.com) Application Support: Phone: 1-800-ANALOG-D



**GaAs pHEMT MMIC 2 WATT POWER AMPLIFIER, 27.3 - 33.5 GHz**

**Gain & Power vs. Supply Current @ 29.5 GHz**

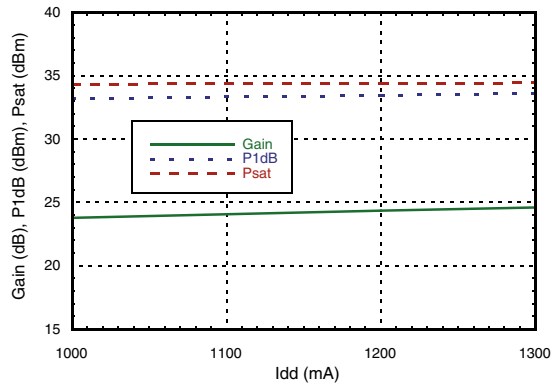

**Gain & Power vs. Supply Voltage @ 29.5 GHz**

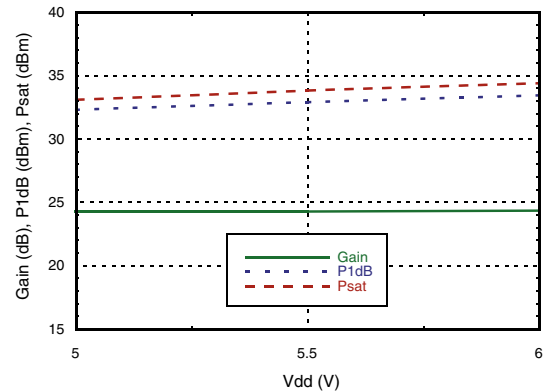

**Power Dissipation**

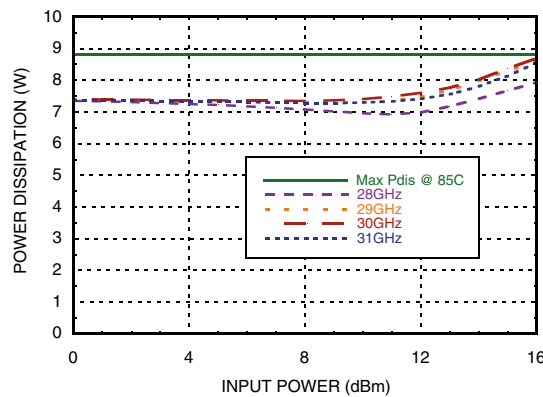

**Absolute Maximum Ratings**

Drain Bias Voltage (Vd)	+7V
RF Input Power (RFIN)	+20 dBm
Channel Temperature	150 °C
Continuous P <sub>diss</sub> (T= 85 °C) (derate 135 mW/°C above 85 °C)	8.8 W
Thermal Resistance (channel to die bottom)	7.4 °C/W
Storage Temperature	-65 to +150 °C
Operating Temperature	-55 to +85 °C

**Typical Supply Current vs. Vdd**

Vdd (V)	Idd (mA)
+5.0	1200
+5.5	1200
+6.0	1200

Note: Amplifier will operate over full voltage ranges shown above. V<sub>gg</sub> adjusted to achieve I<sub>dd</sub> = 1200 mA at +6.0V



**ELECTROSTATIC SENSITIVE DEVICE  
OBSERVE HANDLING PRECAUTIONS**



**GaAs pHEMT MMIC 2 WATT  
POWER AMPLIFIER, 27.3 - 33.5 GHz**

**Outline Drawing**

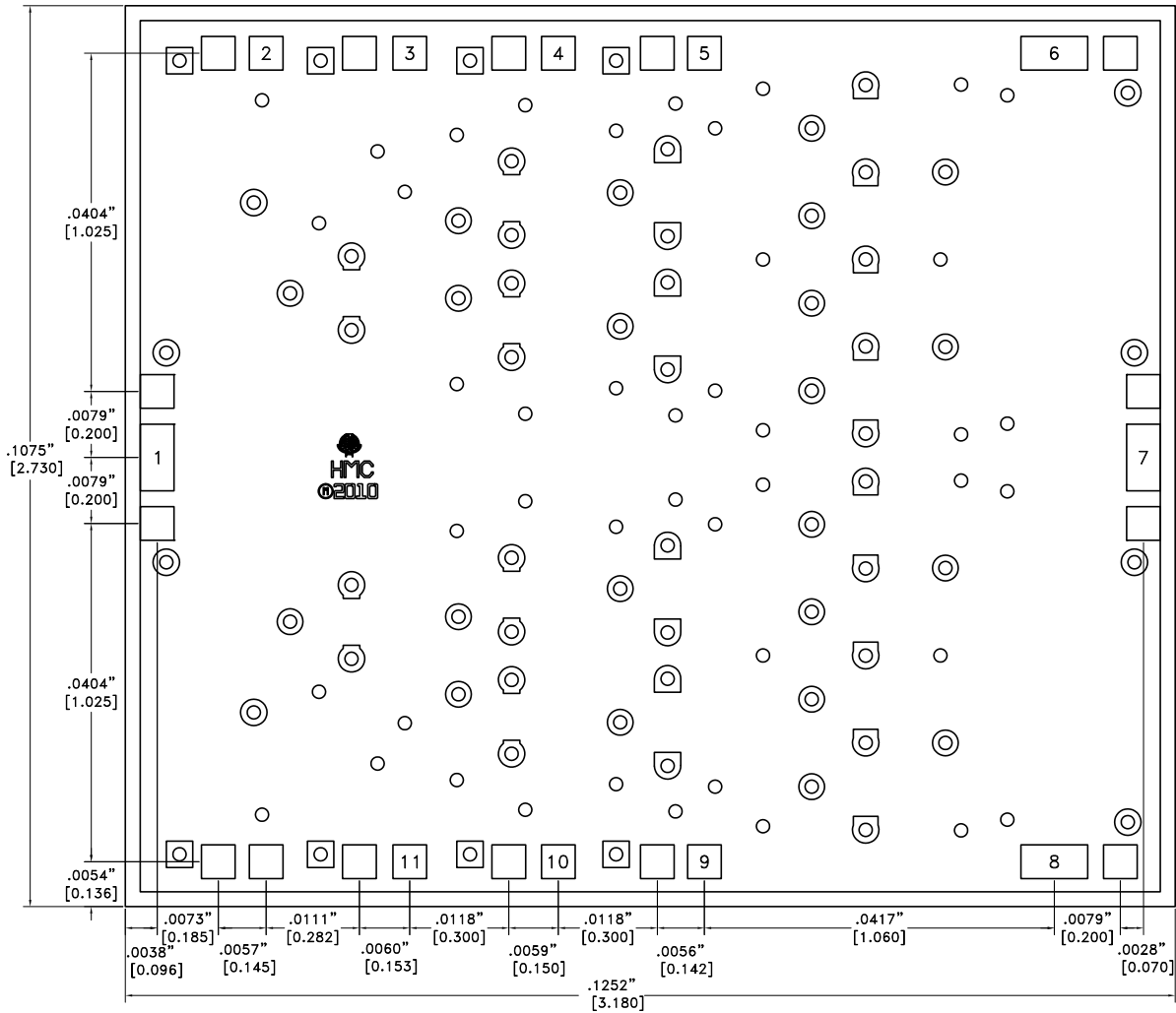

**Die Packaging Information [1]**

Standard	Alternate
GP-1 (Gel Pack)	[2]

[1] Refer to the "Packaging Information" section for die packaging dimensions.

[2] For alternate packaging information contact Hittite Microwave Corporation.

**NOTES:**

1. ALL DIMENSIONS ARE IN INCHES [MM]
2. DIE THICKNESS IS .004"
3. TYPICAL BOND PAD IS .004" SQUARE
4. BACKSIDE METALLIZATION: GOLD
5. BOND PAD METALLIZATION: GOLD
6. BACKSIDE METAL IS GROUND.
7. CONNECTION NOT REQUIRED FOR UNLABELED BOND PADS.
8. OVERALL DIE SIZE ± 0.002"



**GaAs pHEMT MMIC 2 WATT  
POWER AMPLIFIER, 27.3 - 33.5 GHz**

**Pad Descriptions**

Pad Number	Function	Description	Interface Schematic
1	RFIN	This pad is AC coupled and matched to 50 Ohms over the operating frequency range.	
2, 12	Vgg	Gate control for amplifier. External bypass caps 100 pF, 0.01 μF and 4.7 μF are required. Only one pad connection is required as these two pads are connected on-chip.	
3 - 6	Vdd1	Drain bias voltage for the top half of the amplifier. External bypass capacitors of 100 pF required for each pad, followed by common 0.1 μF and 4.7 μF are capacitors.	
7	RFOUT	This pad is AC coupled and matched to 50 Ohms.	
8 - 11	Vdd2	Drain bias voltage for the lower half of the amplifier. External bypass capacitors of 100 pF required for each pad, followed by common 0.1 μF and 4.7 μF are capacitors.	
Die Bottom	GND	Die bottom must be connected to RF/DC ground.	

**Application Circuit**

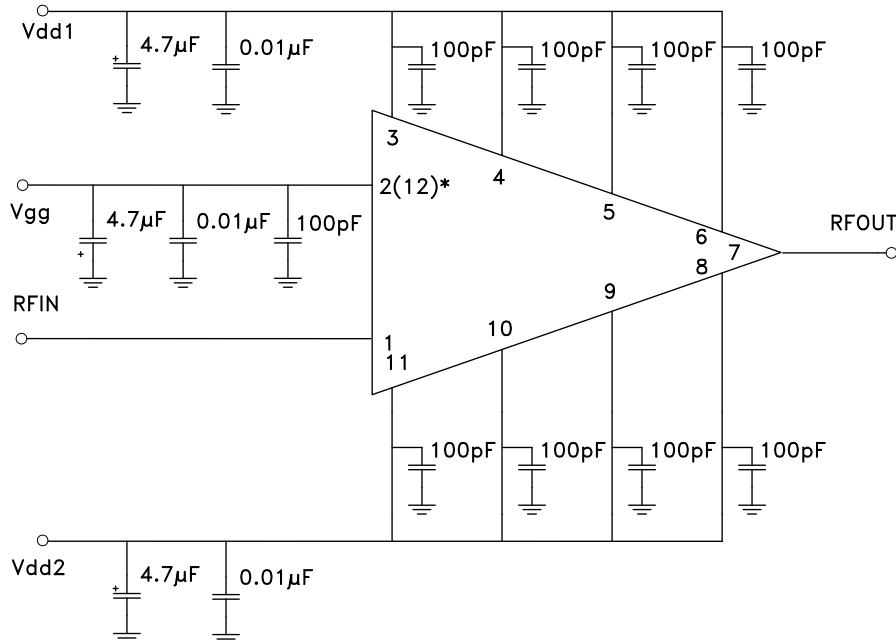

\*Vgg may be applied to either pad 2 or pad 12.

Information furnished by Analog Devices is believed to be accurate and reliable. However, no responsibility is assumed by Analog Devices for its use, nor for any infringements of patents or other rights of third parties that may result from its use. Specifications subject to change without notice. No license is granted by implication or otherwise under any patent or patent rights of Analog Devices. Trademarks and registered trademarks are the property of their respective owners.

For price, delivery, and to place orders: Analog Devices, Inc., One Technology Way, P.O. Box 9106, Norwood, MA 02062-9106 Phone: 781-329-4700 • Order online at [www.analog.com](http://www.analog.com) Application Support: Phone: 1-800-ANALOG-D





**GaAs pHEMT MMIC 2 WATT  
POWER AMPLIFIER, 27.3 - 33.5 GHz**

**Assembly Diagram <sup>[1]</sup>**

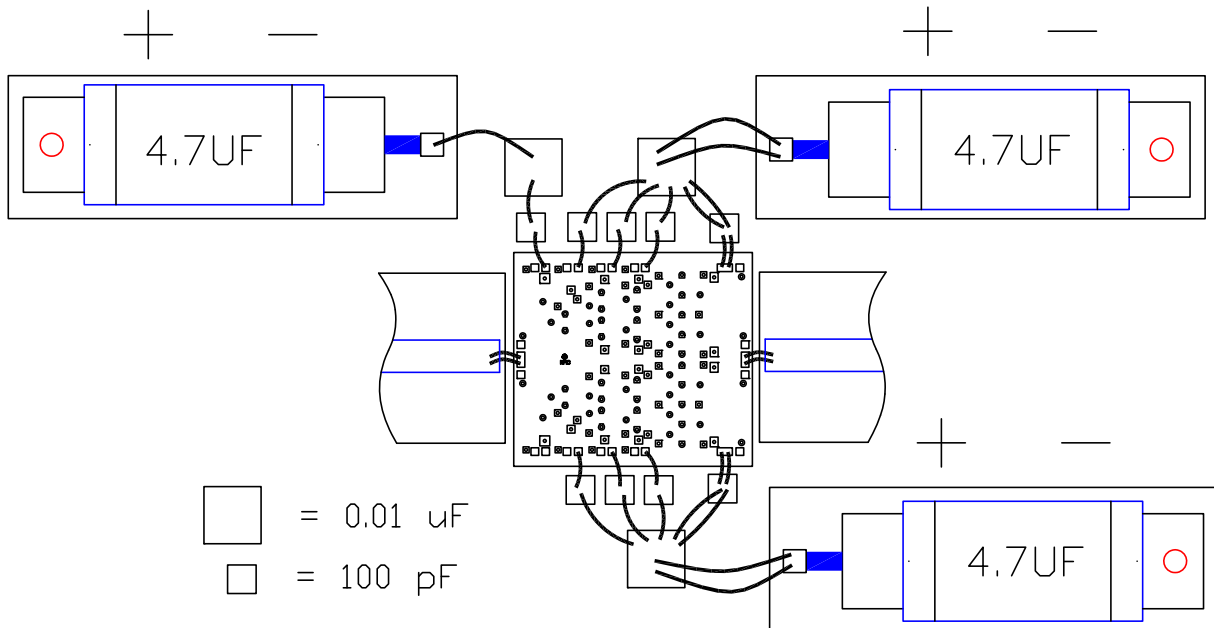

[1] Vgg may be applied to either pad 2 or pad 12.



## GaAs pHEMT MMIC 2 WATT POWER AMPLIFIER, 27.3 - 33.5 GHz

### Mounting & Bonding Techniques for Millimeterwave GaAs MMICs

The die should be attached directly to the ground plane eutectically or with conductive epoxy (see HMC general Handling, Mounting, Bonding Note).

50 Ohm Microstrip transmission lines on 0.127mm (5 mil) thick alumina thin film substrates are recommended for bringing RF to and from the chip (Figure 1). If 0.254mm (10 mil) thick alumina thin film substrates must be used, the die should be raised 0.150mm (6 mils) so that the surface of the die is coplanar with the surface of the substrate. One way to accomplish this is to attach the 0.102mm (4 mil) thick die to a 0.150mm (6 mil) thick molybdenum heat spreader (moly-tab) which is then attached to the ground plane (Figure 2).

Microstrip substrates should be placed as close to the die as possible in order to minimize bond wire length. Typical die-to-substrate spacing is 0.076mm to 0.152 mm (3 to 6 mils).

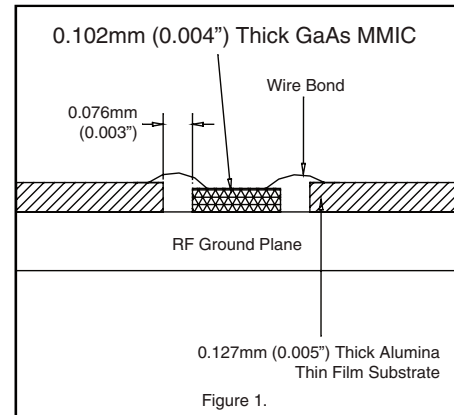

### Handling Precautions

Follow these precautions to avoid permanent damage.

**Storage:** All bare die are placed in either Waffle or Gel based ESD protective containers, and then sealed in an ESD protective bag for shipment. Once the sealed ESD protective bag has been opened, all die should be stored in a dry nitrogen environment.

**Cleanliness:** Handle the chips in a clean environment. DO NOT attempt to clean the chip using liquid cleaning systems.

**Static Sensitivity:** Follow ESD precautions to protect against ESD strikes.

**Transients:** Suppress instrument and bias supply transients while bias is applied. Use shielded signal and bias cables to minimize inductive pick-up.

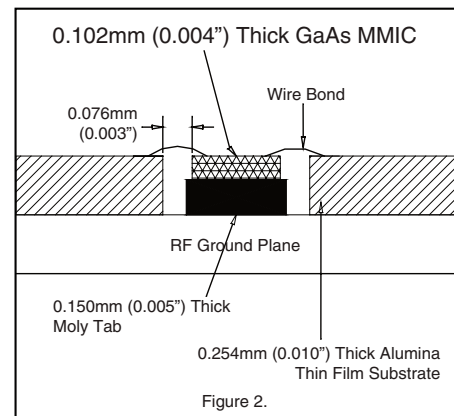

**General Handling:** Handle the chip along the edges with a vacuum collet or with a sharp pair of bent tweezers. The surface of the chip may have fragile air bridges and should not be touched with vacuum collet, tweezers, or fingers.

### Mounting

The chip is back-metallized and can be die mounted with AuSn eutectic preforms or with electrically conductive epoxy. The mounting surface should be clean and flat.

**Eutectic Die Attach:** A 80/20 gold tin preform is recommended with a work surface temperature of 255 °C and a tool temperature of 265 °C. When hot 90/10 nitrogen/hydrogen gas is applied, tool tip temperature should be 290 °C. DO NOT expose the chip to a temperature greater than 320 °C for more than 20 seconds. No more than 3 seconds of scrubbing should be required for attachment.

**Epoxy Die Attach:** Apply a minimum amount of epoxy to the mounting surface so that a thin epoxy fillet is observed around the perimeter of the chip once it is placed into position. Cure epoxy per the manufacturer's schedule.

### Wire Bonding

RF bonds made with two 1 mil wires are recommended. These bonds should be thermosonically bonded with a force of 40-60 grams. DC bonds of 0.001" (0.025 mm) diameter, thermosonically bonded, are recommended. Ball bonds should be made with a force of 40-50 grams and wedge bonds at 18-22 grams. All bonds should be made with a nominal stage temperature of 150 °C. A minimum amount of ultrasonic energy should be applied to achieve reliable bonds. All bonds should be as short as possible, less than 12 mils (0.31 mm).

**GaAs pHEMT MMIC 2 WATT  
POWER AMPLIFIER, 27.3 - 33.5 GHz****Notes:**