



Chipsmall Limited consists of a professional team with an average of over 10 year of expertise in the distribution of electronic components. Based in Hongkong, we have already established firm and mutual-benefit business relationships with customers from,Europe,America and south Asia,supplying obsolete and hard-to-find components to meet their specific needs.

With the principle of “Quality Parts,Customers Priority,Honest Operation,and Considerate Service”,our business mainly focus on the distribution of electronic components. Line cards we deal with include Microchip,ALPS,ROHM,Xilinx,Pulse,ON,Everlight and Freescale. Main products comprise IC,Modules,Potentiometer,IC Socket,Relay,Connector.Our parts cover such applications as commercial,industrial, and automotives areas.

We are looking forward to setting up business relationship with you and hope to provide you with the best service and solution. Let us make a better world for our industry!



## Contact us

Tel: +86-755-8981 8866 Fax: +86-755-8427 6832

Email & Skype: info@chipsmall.com Web: www.chipsmall.com

Address: A1208, Overseas Decoration Building, #122 Zhenhua RD., Futian, Shenzhen, China





**470° ANALOG PHASE SHIFTER,  
18 - 24 GHz**

**Typical Applications**

The HMC933LP4E is ideal for:

- EW Receivers
- Military Radar
- Test Equipment
- Satellite Communications
- Beam Forming Modules

**Features**

- Wide Bandwidth: 18 - 24 GHz
- 470° Phase Shift
- Low Insertion Loss: 4.5 dB
- Low Phase Error: ±10 deg Typ.
- Single Positive Voltage Control
- 24 Lead 4x4 mm QFN Package: 16 mm<sup>2</sup>

**Functional Diagram**

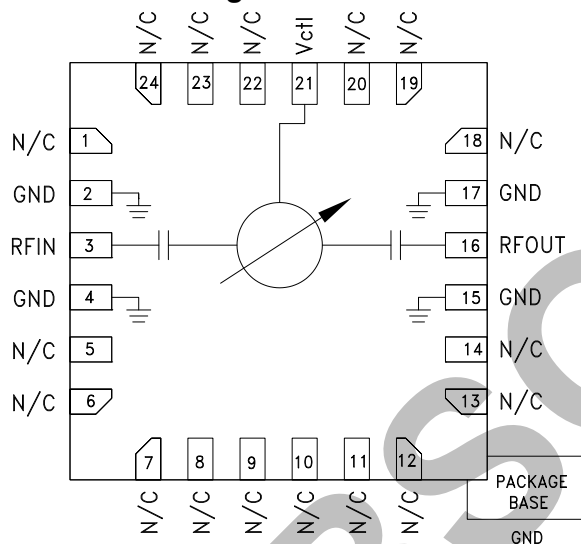

**General Description**

The HMC933LP4E is an Analog Phase Shifter which is controlled via an analog control voltage from 0 to +13V. The HMC933LP4E provides a continuously variable phase shift of 0 to 470 degrees from 18 to 24 GHz, with extremely consistent low insertion loss versus phase shift and frequency. The high accuracy HMC933LP4E is monotonic with respect to control voltage and features a typical low phase error of ±10 degrees over a wide bandwidth. The HMC933LP4E is housed in an RoHS compliant 4x4 mm QFN leadless package.

**Electrical Specifications, T<sub>A</sub> = +25° C, 50 Ohm System**

| Parameter   | Min. | Typ.     | Max. | Units  |
|---|------|----------|------|--------|
| Frequency Range   | 18   |          | 24   | GHz    |
| Phase Shift Range   |      | 470      |      | deg    |
| Insertion Loss  |      | 4.5      |      | dB     |
| Return Loss (input and output)                            |      | 14       |      | dB     |
| Control Voltage Range                                     | 0    |          | 13   | V      |
| Control Current Range                                     |      |          | ± 1  | mA     |
| Input IP3   |      | 33       |      | dBm    |
| Input Power @ - 5° Shift In Insertion Phase (Vctl = 0V)   |      | 11       |      | dBm    |
| Input Power @ - 2° Shift In Insertion Phase (Vctl = 0.5V) |      | 12       |      | dBm    |
| Phase Voltage Sensitivity                                 |      | 34       |      | deg/V  |
| Phase Error (peak) *                                      |      | +9 / -17 |      | deg    |
| Phase Error (average) *                                   |      | +3 / -11 |      | deg    |
| Modulation Bandwidth                                      |      | 90       |      | MHz    |
| Insertion Phase Temperature Sensitivity                   |      | 0.10     |      | deg/°C |

\* Up to a phase shift range of 380 degrees.



**470° ANALOG PHASE SHIFTER,  
18 - 24 GHz**

**Insertion Loss vs. Frequency**

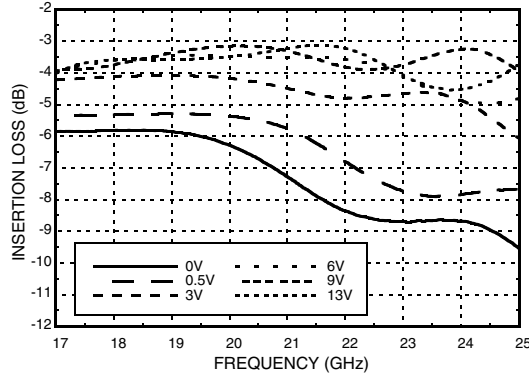

**Insertion Loss vs. Vctl , F = 21 GHz**

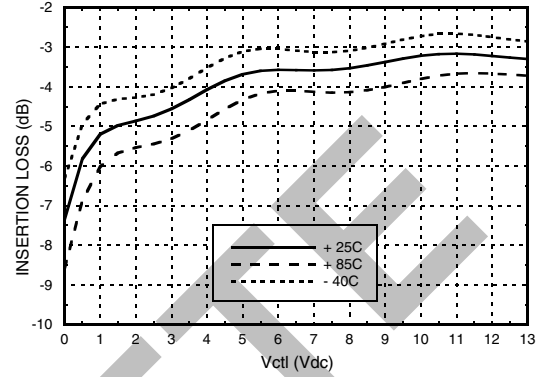

**Phase Shift vs. Vctl**

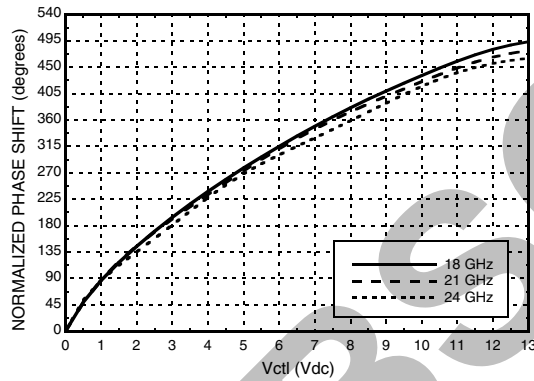

**Phase Shift vs. Frequency @ Vctl = 6V  
(Relative to Vctl = 0V)**

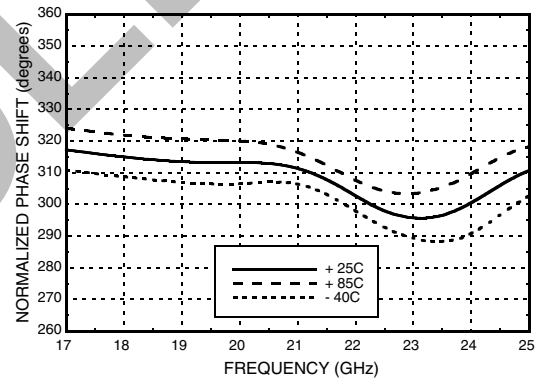

**Phase Shift vs. Frequency  
(Relative to Vctl = 0V) Vctl = 0.5 to 13V**

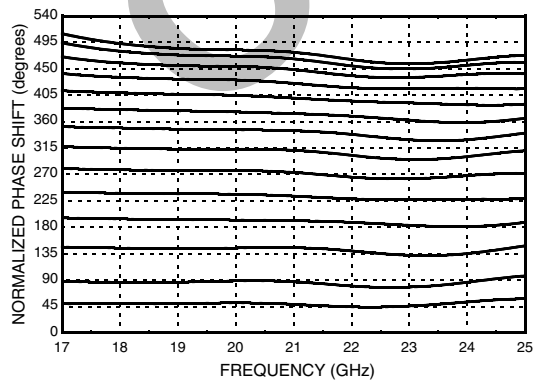

**Phase Error vs. Frequency, Fmean = 21 GHz [1]**

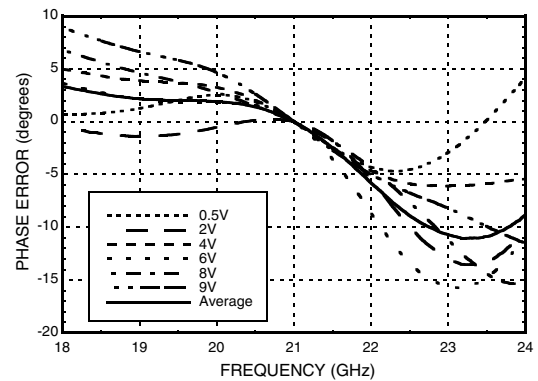

[1] 0 to 9V provides 0 - 380 degrees phase shift range





**470° ANALOG PHASE SHIFTER,  
18 - 24 GHz**

**Second Harmonics vs. Vctl, F = 21 GHz**

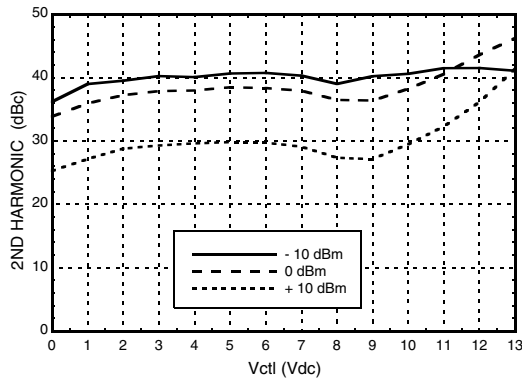

**Input IP3 vs. Vctl, F = 21 GHz**

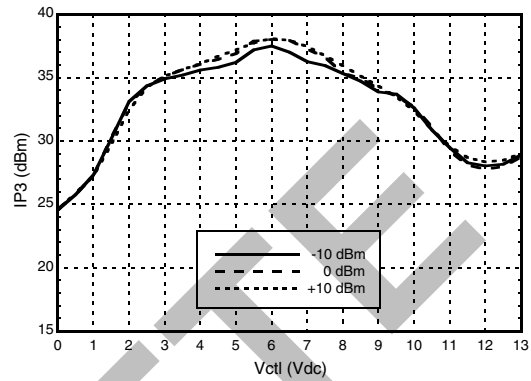

**Insertion Loss vs. Pin @ 18 GHz**

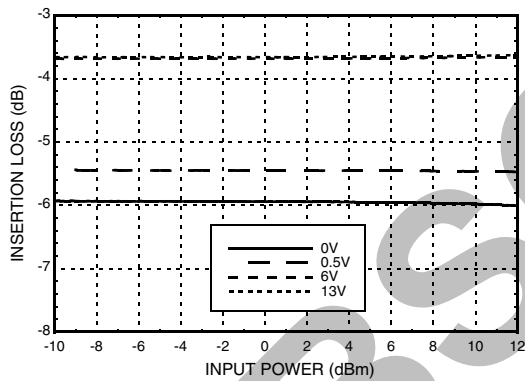

**Insertion Loss vs. Pin @ 21 GHz**

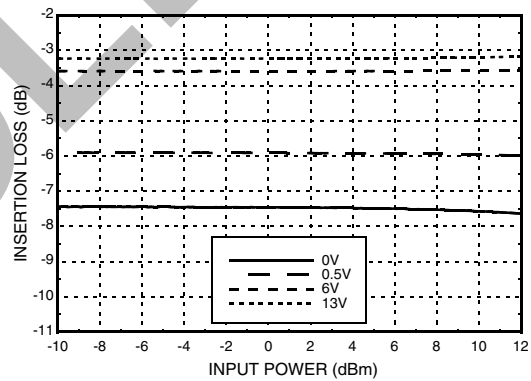

**Insertion Loss vs. Pin @ 24 GHz**

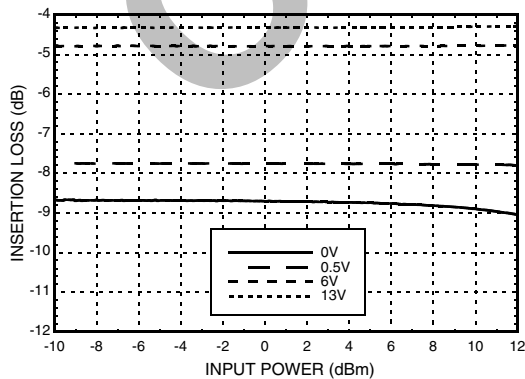

**Phase Shift vs. Pin @ 18 GHz**

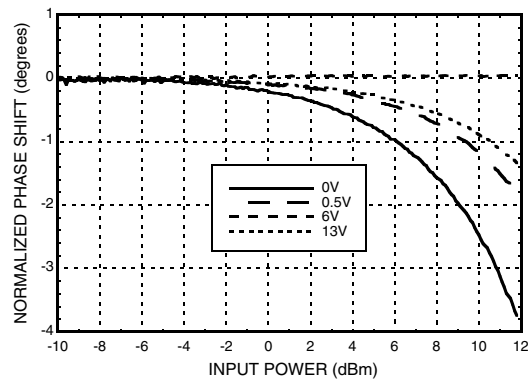

Information furnished by Analog Devices is believed to be accurate and reliable. However, no responsibility is assumed by Analog Devices for its use, nor for any infringements of patents or other rights of third parties that may result from its use. Specifications subject to change without notice. No license is granted by implication or otherwise under any patent or patent rights of Analog Devices. Trademarks and registered trademarks are the property of their respective owners.

For price, delivery, and to place orders: Analog Devices, Inc., One Technology Way, P.O. Box 9106, Norwood, MA 02062-9106 Phone: 781-329-4700 • Order online at [www.analog.com](http://www.analog.com) Application Support: Phone: 1-800-ANALOG-D



**470° ANALOG PHASE SHIFTER,  
18 - 24 GHz**

**Phase Shift vs. Pin @ 21 GHz**

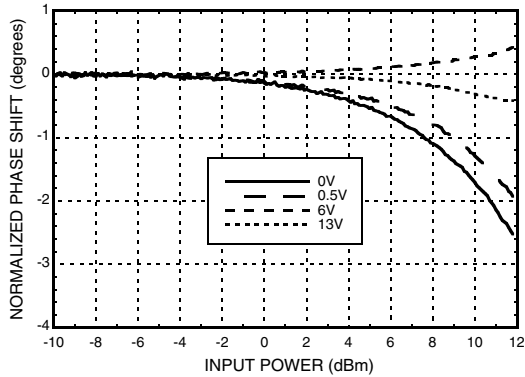

**Phase Shift vs. Pin @ 24 GHz**

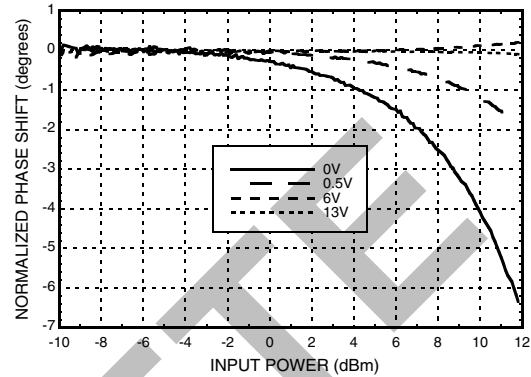

**Input Return Loss vs.  
Frequency, Vctl = 0 to +13V**

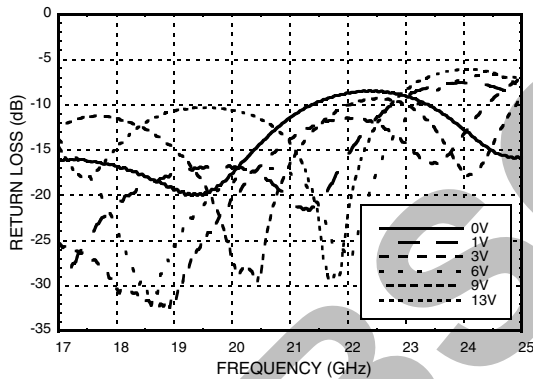

**Output Return Loss vs.  
Frequency, Vctl = 0 to +13V**

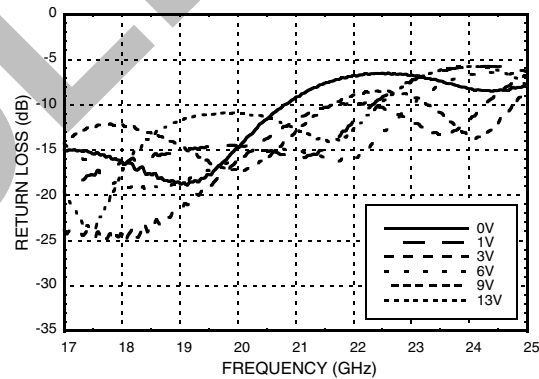

**Absolute Maximum Ratings**

|                        |                |
|------------------------|----------------|
| Input Power (RFIN)     | +26 dBm        |
| Control Voltage (Vctl) | -0.5V to +15V  |
| Storage Temperature    | -65 to +150 °C |
| ESD Sensitivity (HBM)  | Class 1B       |

**Reliability Information**

|   |               |
|---|---------------|
| Junction Temperature (Tj)                                 | 150 °C        |
| Nominal Junction Temperature<br>(T = 85 °C, Pin = 10 dBm) | 87 °C         |
| Thermal Resistance<br>(Junction to GND Paddle)            | 80 °C/W       |
| Operating Temperature                                     | -40 to +85 °C |



**ELECTROSTATIC SENSITIVE DEVICE  
OBSERVE HANDLING PRECAUTIONS**



**470° ANALOG PHASE SHIFTER,  
18 - 24 GHz**

**Outline Drawing**

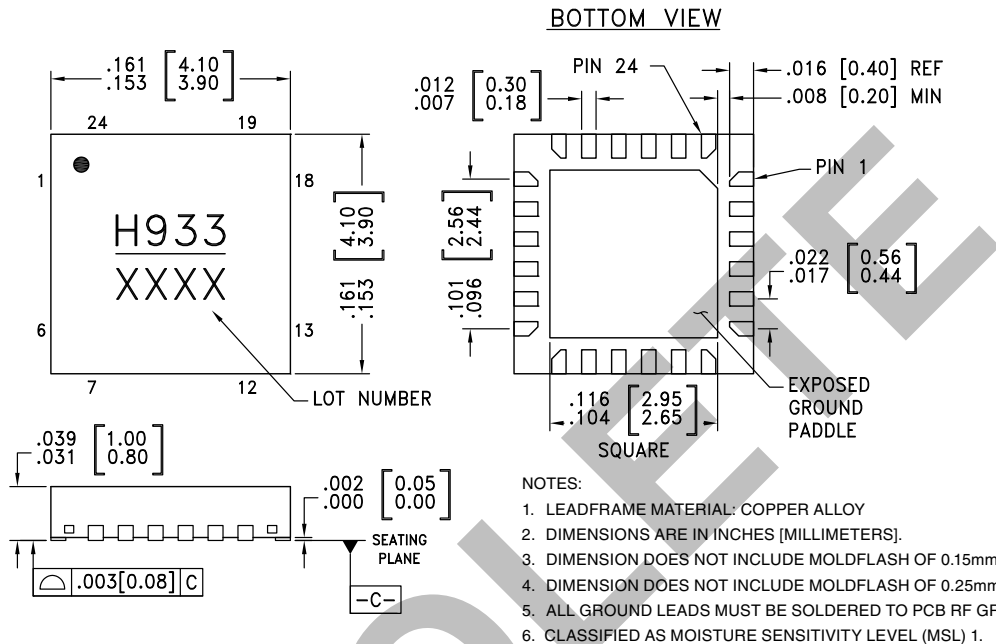

**Package Information**

| Part Number | Package Body Material                              | Lead Finish   | MSL Rating          | Package Marking <sup>[1]</sup> |
|-------------|--|---------------|---------------------|--------------------------------|
| HMC933LP4E  | RoHS-compliant Low Stress Injection Molded Plastic | 100% matte Sn | MSL1 <sup>[2]</sup> | H933<br>XXXX                   |

[1] 4-Digit lot number XXXX

[2] Max peak reflow temperature of 260 °C

**Pin Descriptions**

| Pin Number                     | Function | Description   | Interface Schematic |
|--------------------------------|----------|---|---------------------|
| 1, 5 - 14,<br>18 - 20, 22 - 24 | N/C      | No connection required. These pins may be connected to RF/DC ground without affecting performance.  |                     |
| 2, 4, 15, 17                   | GND      | Ground: Backside of package has exposed metal ground slug that must be connected to ground thru a short path. Vias under the device are required.                                     |                     |
| 3                              | RFIN     | Port is DC blocked.   |                     |
| 16                             | RFOUT    | Port is DC blocked.   |                     |
| 21                             | Vctl     | Phase shift control pin. Application of a voltage between 0 and 13 volts causes the transmission phase to change. The DC equivalent circuit is a series connected diode and resistor. |                     |

Information furnished by Analog Devices is believed to be accurate and reliable. However, no responsibility is assumed by Analog Devices for its use, nor for any infringements of patents or other rights of third parties that may result from its use. Specifications subject to change without notice. No license is granted by implication or otherwise under any patent or patent rights of Analog Devices. Trademarks and registered trademarks are the property of their respective owners.

For price, delivery, and to place orders: Analog Devices, Inc., One Technology Way, P.O. Box 9106, Norwood, MA 02062-9106 Phone: 781-329-4700 • Order online at [www.analog.com](http://www.analog.com) Application Support: Phone: 1-800-ANALOG-D



**Evaluation PCB**

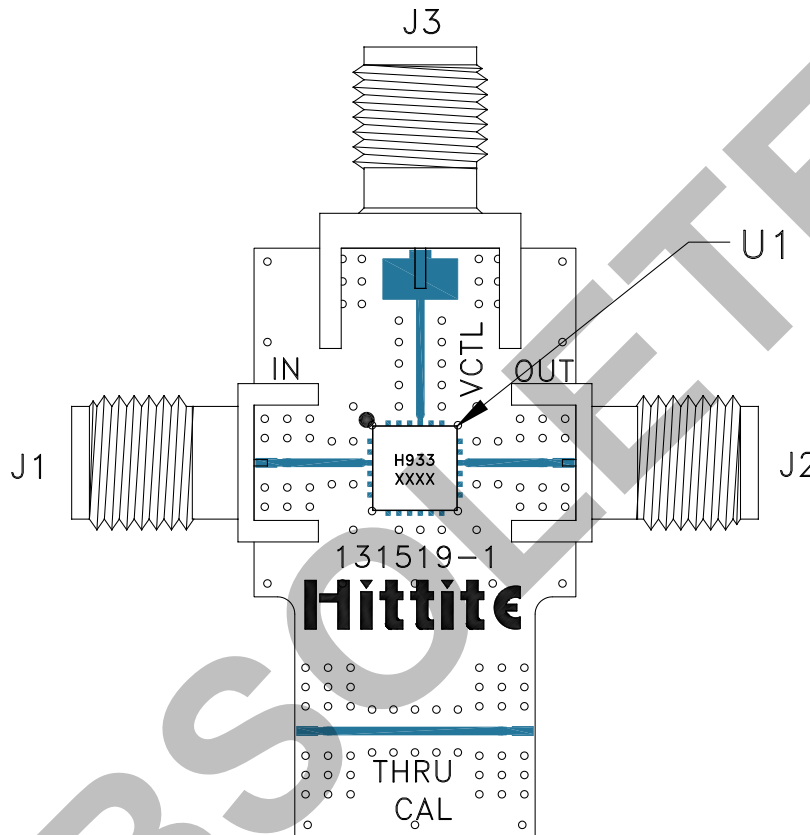

**List of Materials for Evaluation PCB 131521 [1]**

| Item    | Description                     |
|---------|---------------------------------|
| J1, J2  | PCB Mount SMA Connector, SRI    |
| J3      | PCB Mount SMA Connector         |
| U1      | HMC933LP4E Analog Phase Shifter |
| PCB [2] | 131519 Evaluation PCB           |

[1] Reference this number when ordering complete evaluation PCB

[2] Circuit Board Material: Rogers 4350

The circuit board used in the application should use RF circuit design techniques. Signal lines should have 50 Ohm impedance while the package ground leads and exposed paddle should be connected directly to the ground plane similar to that shown. A sufficient number of via holes should be used to connect the top and bottom ground planes. The evaluation board should be mounted to an appropriate heat sink. The evaluation circuit board shown is available from Hittite upon request.