



Chipsmall Limited consists of a professional team with an average of over 10 year of expertise in the distribution of electronic components. Based in Hongkong, we have already established firm and mutual-benefit business relationships with customers from,Europe,America and south Asia,supplying obsolete and hard-to-find components to meet their specific needs.

With the principle of "Quality Parts,Customers Priority,Honest Operation,and Considerate Service",our business mainly focus on the distribution of electronic components. Line cards we deal with include Microchip,ALPS,ROHM,Xilinx,Pulse,ON,Everlight and Freescale. Main products comprise IC,Modules,Potentiometer,IC Socket,Relay,Connector.Our parts cover such applications as commercial,industrial, and automotives areas.

We are looking forward to setting up business relationship with you and hope to provide you with the best service and solution. Let us make a better world for our industry!



## Contact us

Tel: +86-755-8981 8866 Fax: +86-755-8427 6832

Email & Skype: info@chipsmall.com Web: www.chipsmall.com

Address: A1208, Overseas Decoration Building, #122 Zhenhua RD., Futian, Shenzhen, China



## 0.5 dB LSB GaAs MMIC 5-BIT DIGITAL ATTENUATOR, 0.1 - 33 GHz

### Typical Applications

The HMC941ALP4E is ideal for:

- Fiber Optics & Broadband Telecom
- Microwave Radio & VSAT
- Military Radios, Radar & ECM
- Space Applications
- Sensors
- Test & Measurement Equipment

### Features

- 0.5 dB LSB Steps to 15.5 dB
- Single Positive Control Line Per Bit
- ±0.5 dB Typical Bit Error
- High Input IP3: +45 dBm
- 16mm<sup>2</sup> Leadless SMT Plastic Package

### Functional Diagram

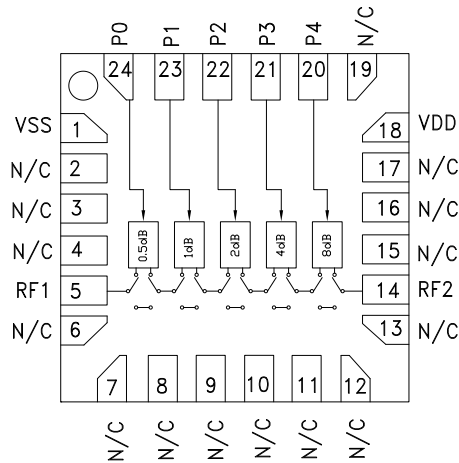

### General Description

The HMC941ALP4E is a broadband 5-bit GaAs IC digital attenuators in low cost leadless surface mount packages. Covering 0.1 to 33.0 GHz, the insertion loss is less than 4 dB typical. The attenuator bit values are 0.5 (LSB), 1, 2, 4, 8, for a total attenuation of 15.5 dB. Attenuation accuracy is excellent at ±0.3 dB typical step error with an IIP3 of +45 dBm. Five control voltage inputs, toggled between +5V and 0V, are used to select each attenuation state.

### Electrical Specifications, $T_A = +25^\circ C$ , With $V_{dd} = +5V$ , $V_{ss} = -5V$ , $P_0 - P_4 = 0/ +5V$

Parameter	Frequency (GHz)	Min.	Typ.	Max.	Units
Insertion Loss	0.1 - 18.0 GHz		3.5	4.5	dB
	18.0 - 26.5 GHz		4.0	6.0	dB
	26.5 - 33.0 GHz		5.0	6.5	dB
Attenuation Range	0.1 - 33.0 GHz		15.5		dB
Return Loss (RF1 & RF2, All Atten. States)	0.1 - 33.0 GHz		12		dB
Attenuation Accuracy: (Referenced to Insertion Loss)	0.5 - 7.5 dB States	0.1 - 33.0 GHz	± (0.3 + 4% of Atten. Setting) Max		dB
	8 - 15.5 dB States	0.1 - 33.0 GHz	± (0.3 + 8% of Atten. Setting) Max		dB
Input Power for 0.1 dB Compression	0.1 - 0.5 GHz		22		dBm
	0.5 - 33.0 GHz		26		dBm
Input Third Order Intercept Point (Two-Tone Input Power = +8 dBm Each Tone)	0.1 - 0.5 GHz		45		dBm
	0.5 - 33.0 GHz		42		dBm
Switching Characteristics	0.1 - 33.0 GHz	tRISE, tFALL (10/90% RF)	40		ns
		tON/tOFF (50% CTL to 10/90% RF)	50		ns
		Idd	2.5	4.5	6.5
Iss	0.1 - 33.0 GHz	-7.0	-6.0	-3.0	mA

# HMC941ALP4E\* PRODUCT PAGE QUICK LINKS

Last Content Update: 02/23/2017

---

## COMPARABLE PARTS

View a parametric search of comparable parts.

## EVALUATION KITS

- HMC941ALP4 Evaluation Board

## DOCUMENTATION

### Data Sheet

- HMC941ALP4E: 0.5 dB LSB GaAs MMIC 5-Bit Digital Attenuator, 0.1 - 33 GHz Data Sheet

## TOOLS AND SIMULATIONS

- HMC941ALP4 S-Parameters

## DESIGN RESOURCES

- HMC941ALP4E Material Declaration
- PCN-PDN Information
- Quality And Reliability
- Symbols and Footprints

## DISCUSSIONS

View all HMC941ALP4E EngineerZone Discussions.

## SAMPLE AND BUY

Visit the product page to see pricing options.

## TECHNICAL SUPPORT

Submit a technical question or find your regional support number.

## DOCUMENT FEEDBACK

Submit feedback for this data sheet.

---



**0.5 dB LSB GaAs MMIC 5-BIT DIGITAL ATTENUATOR, 0.1 - 33 GHz**

**Insertion Loss vs. Temperature**

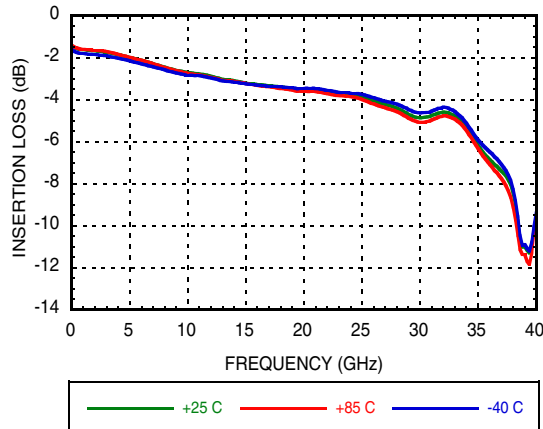

**Normalized Attenuation**  
(Only Major States are Shown)

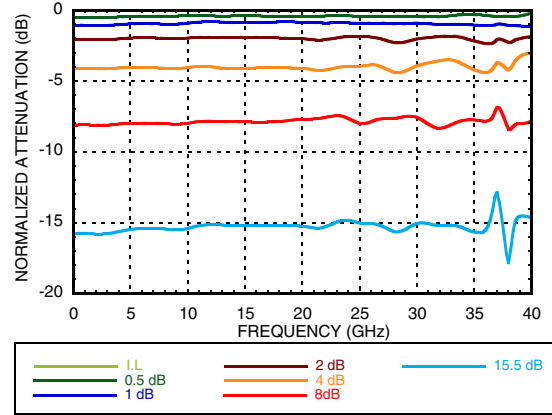

**Input Return Loss**  
(Only Major States are Shown)

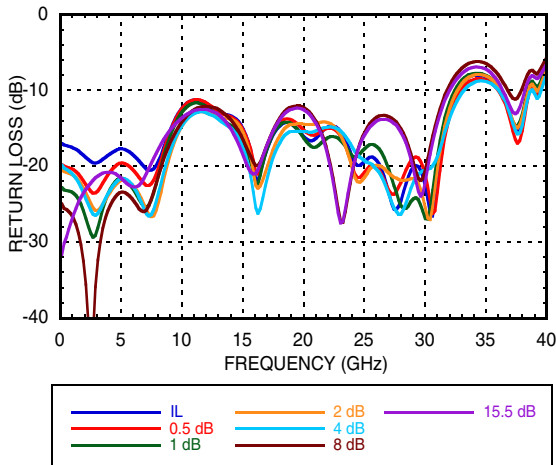

**Output Return Loss**  
(Only Major States are Shown)

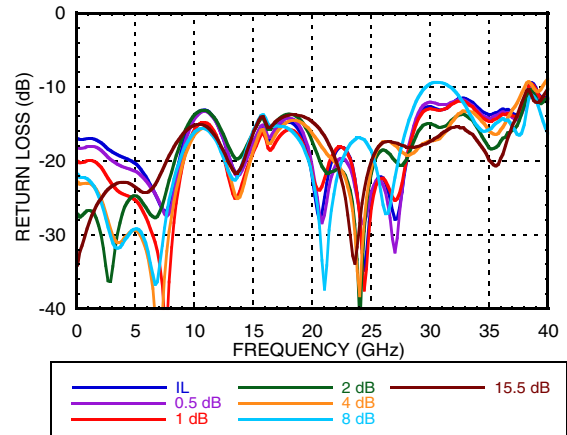

**Bit Error vs. Attenuation State**

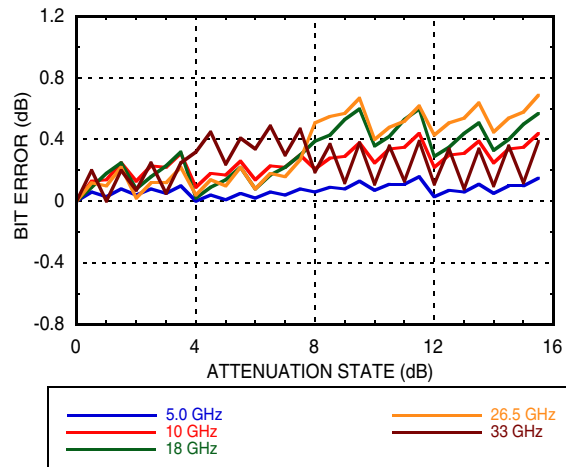

**Bit Error vs. Frequency**  
(Only Major States are Shown)

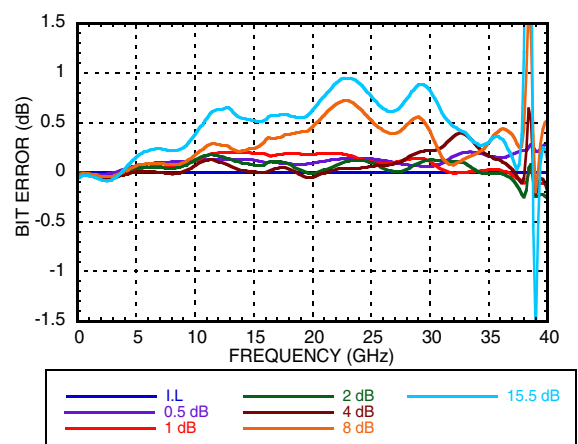

**0.5 dB LSB GaAs MMIC 5-BIT DIGITAL ATTENUATOR, 0.1 - 33 GHz**

**Relative Phase vs. Frequency**  
(Only Major States are Shown)

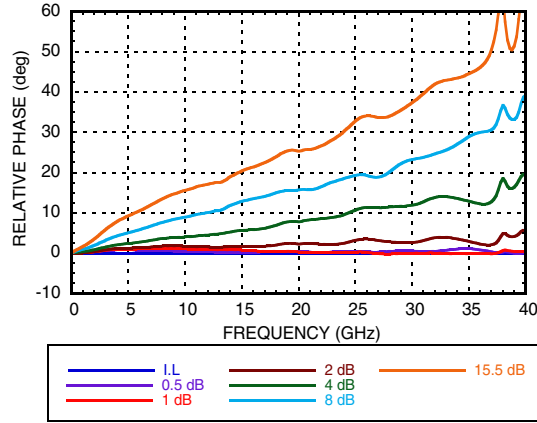

**Step Attenuation vs. Attenuation State**  
**0.1 - 18 GHz**

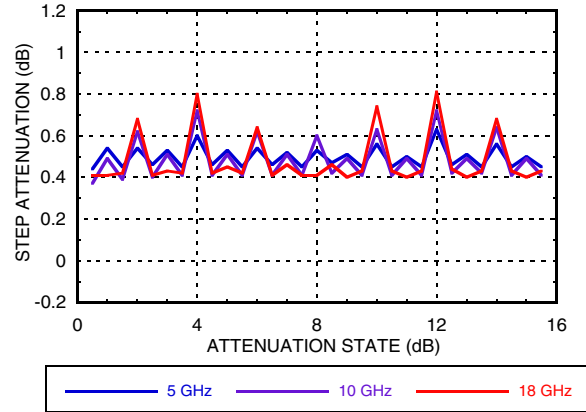

**Step Attenuation vs. Attenuation State**  
**18 - 33 GHz**

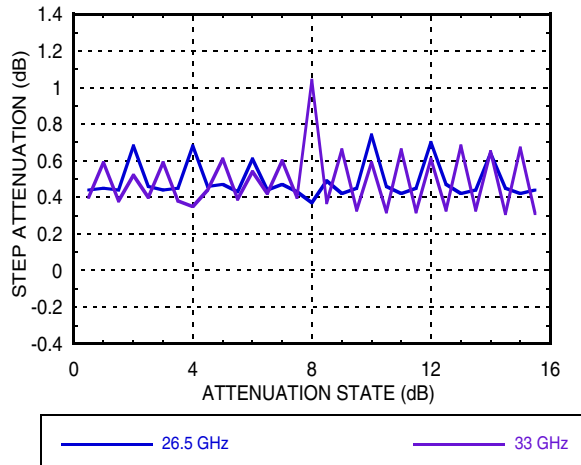

**Input Power for 0.1 dB Compression**

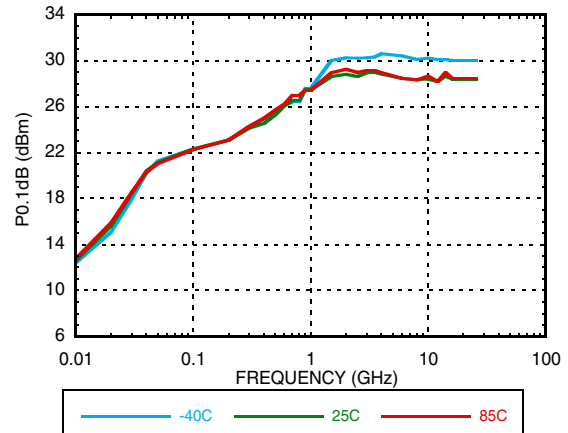

**Input IP3 Over Major Attenuation States**

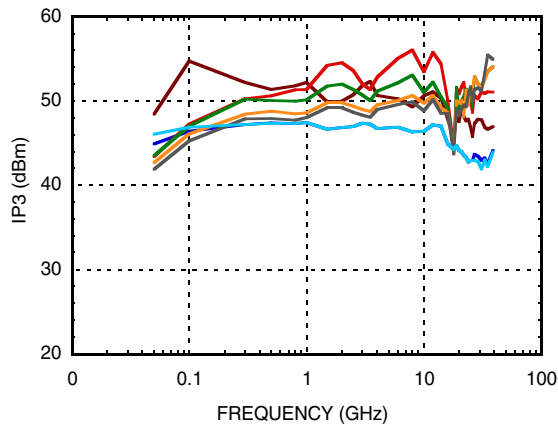

**Input IP3 vs. Temperature**  
(Minimum Attenuation State)

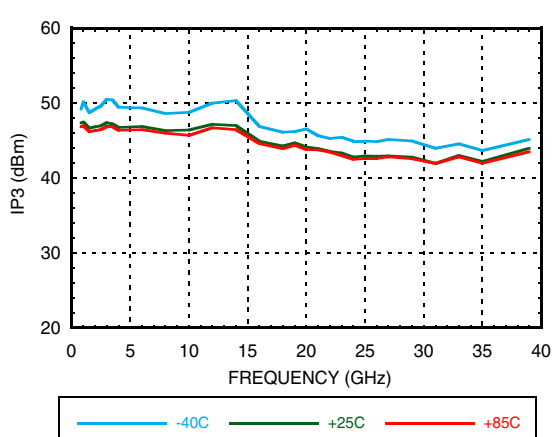

## 0.5 dB LSB GaAs MMIC 5-BIT DIGITAL ATTENUATOR, 0.1 - 33 GHz

### Absolute Maximum Ratings

RF Input Power (0.1 to 33.0 GHz)	+27dBm
Control Voltage (P0 to P4)	Vdd+0.5
Vdd	+7 Vdc
Vss	-7 Vdc
Channel Temperature	150 °C
Continuous Pdiss (T = 85 °C) (derate 6.8 mW/°C above 85 °C)	0.453 W
Thermal Resistance	143.5 °C/W
Storage Temperature	-65 to 150 °C
Operating Temperature	-40 to +85 °C
ESD Sensitivity (HBM)	Class1A

### Bias Voltages & Currents

Vdd	+5V @ 4.5 mA
Vss	-5V @ 6 mA

### Control Voltage

State	Bias Condition
Low	0 to 0.8V @ 1 μA (Typ)
High	2 to 5V @ 1 μA (Typ)



ELECTROSTATIC SENSITIVE DEVICE  
OBSERVE HANDLING PRECAUTIONS

### Outline Drawing

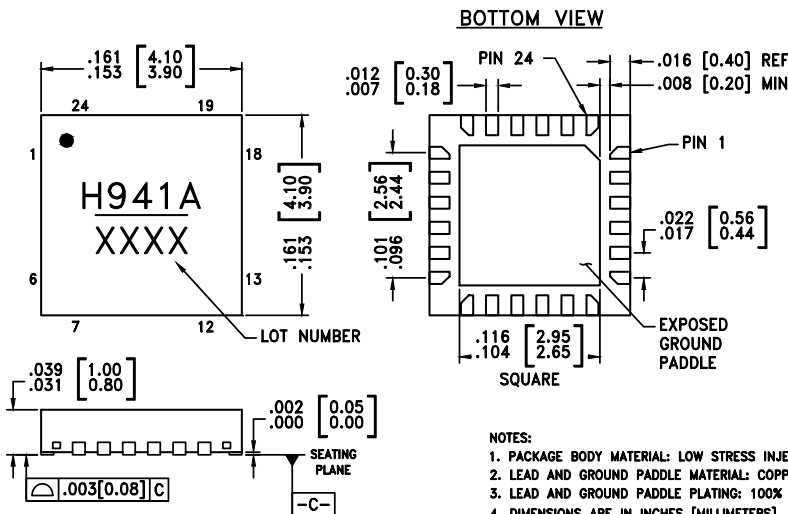

### Package Information

Part Number	Package Body Material	Lead Finish	MSL Rating	Package Marking <sup>[2]</sup>
HMC941ALP4E	RoHS-compliant Low Stress Injection Molded Plastic	100% matte Sn	MSL3 <sup>[1]</sup>	H941A XXXX

[1] Max peak reflow temperature of 260 °C

[2] 4-Digit lot number XXXX



## 0.5 dB LSB GaAs MMIC 5-BIT DIGITAL ATTENUATOR, 0.1 - 33 GHz

### Truth Table

Control Voltage Input					Attenuation State RF1 - RF2
P4 8 dB	P3 4 dB	P2 2 dB	P1 1 dB	P0 0.5 dB	
High	High	High	High	High	Reference I.L.
High	High	High	High	Low	0.5 dB
High	High	High	Low	High	1 dB
High	High	Low	High	High	2 dB
High	Low	High	High	High	4 dB
Low	High	High	High	High	8 dB
Low	Low	Low	Low	Low	15.5 dB

Any Combination of the above states will provide an attenuation approximately equal to the sum of the bits selected.

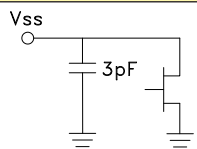
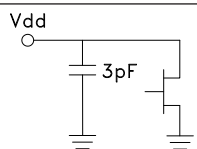
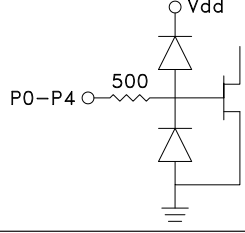
### Pin Descriptions

Pad Number	Function	Description	Interface Schematic
1	Vss	Negative Bias -5V	
2-4, 6-13, 15-17, 19	N/C	The pins are not connected internally; however, all data shown herein was measured with these pins connected to RF/DC ground externally.	
5, 14	RF1, RF2	These pins are DC coupled and matched to 50 Ohm. Blocking capacitors are required if RF line potential is not equal to 0V.	
18	Vdd	Positive Bias +5V	
20 - 24	P0 - P4	See truth table and control voltage table.	
	GND	Package bottom must be connected to RF/DC ground.	

## 0.5 dB LSB GaAs MMIC 5-BIT DIGITAL ATTENUATOR, 0.1 - 33 GHz

### Evaluation PCB

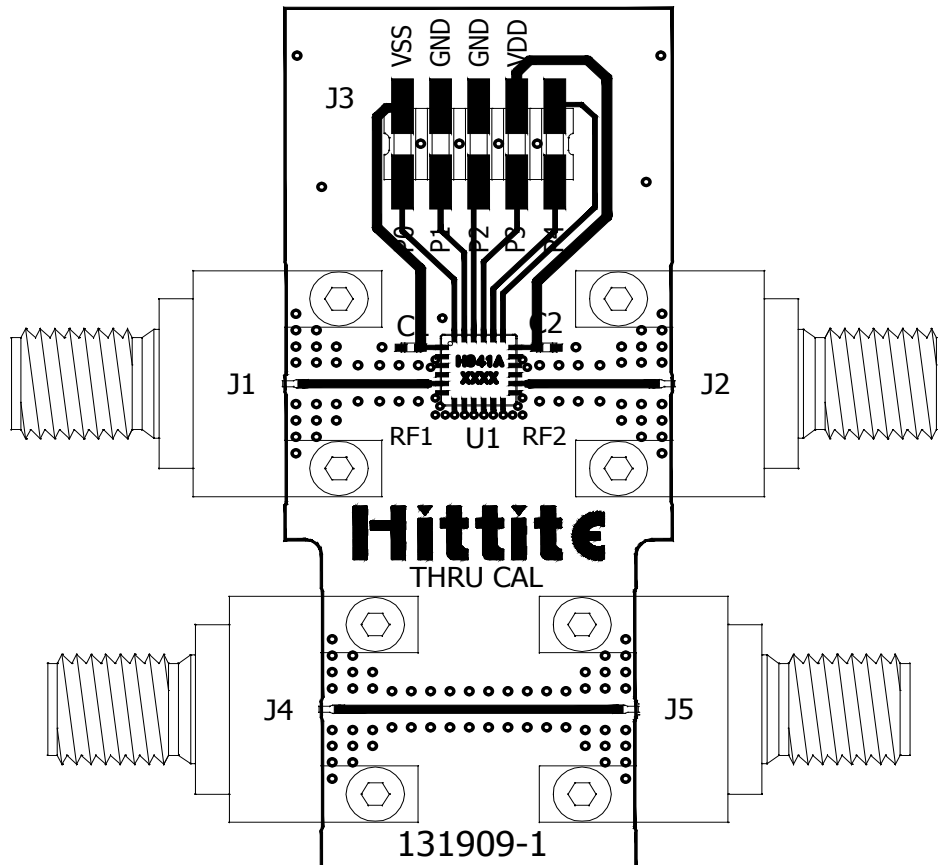

### List of Materials for Evaluation PCB EV1HMC941ALP4 [1]

Item	Description
J1, J2, J4, J5	2.9 mm PC Mount RF Connector
J3	DC Connector
C1, C2	1000 pF Capacitor, 0402 Pkg.
U1	HMC941ALP4E Digital Attenuator
PCB [2]	131909 Evaluation Board

[1] Reference this number when ordering complete evaluation PCB

[2] Circuit Board Material: Rogers 4350

The circuit board used in the application should use RF circuit design techniques. Signal lines should have 50 Ohm impedance while the package ground leads should be connected directly to the ground plane similar to that shown. A sufficient number of via holes should be used to connect the top and bottom ground planes. The evaluation circuit board shown is available from Analog Devices upon request.