



Chipsmall Limited consists of a professional team with an average of over 10 year of expertise in the distribution of electronic components. Based in Hongkong, we have already established firm and mutual-benefit business relationships with customers from,Europe,America and south Asia,supplying obsolete and hard-to-find components to meet their specific needs.

With the principle of “Quality Parts,Customers Priority,Honest Operation,and Considerate Service”,our business mainly focus on the distribution of electronic components. Line cards we deal with include Microchip,ALPS,ROHM,Xilinx,Pulse,ON,Everlight and Freescale. Main products comprise IC,Modules,Potentiometer,IC Socket,Relay,Connector.Our parts cover such applications as commercial,industrial, and automotives areas.

We are looking forward to setting up business relationship with you and hope to provide you with the best service and solution. Let us make a better world for our industry!



Contact us

Tel: +86-755-8981 8866 Fax: +86-755-8427 6832

Email & Skype: info@chipsmall.com Web: www.chipsmall.com

Address: A1208, Overseas Decoration Building, #122 Zhenhua RD., Futian, Shenzhen, China





GaAs MMIC SP4T REFLECTIVE SWITCH, 23 - 30 GHz

Typical Applications

The HMC944LC4 is ideal for:

- Telecom Infrastructure
- Microwave Radio & VSAT
- Military & Space Hybrids
- Test Instrumentation
- SATCOM & Sensors

Functional Diagram

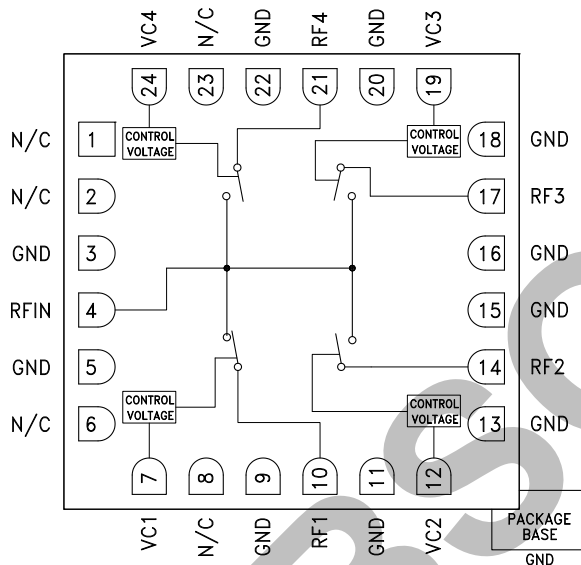

Features

- Broadband Performance: 23 - 30 GHz
- High Isolation: 35 dB
- Insertion Loss: 2.8 dB
- 24 Lead 4x4mm SMT Package: 16mm²

General Description

The HMC944LC4 is a broadband reflective GaAs MESFET SP4T switch in a compact 4x4 mm ceramic package. Covering 23 to 30 GHz, this switch offers high isolation and low insertion loss. The HMC944LC4 is controlled with 0/ -3V logic, exhibits fast switching speed and consumes much less DC current than pin diode based solutions. With its compact form factor, the HMC944LC4 is ideal for microwave radio as well as SATCOM and sensor applications. The HMC944LC4 is housed in a leadless 4x4 mm SMT package which is compatible with surface mount manufacturing techniques.

Electrical Specifications, $T_A = +25^\circ C$, With 0/-3V Control, 50 Ohm System

Parameter	Frequency	Min.	Typ.	Max.	Units
Insertion Loss	(RFC to RF1, RF4)	23 - 30 GHz	2.8	4	dB
	(RFC to RF2, RF3)		3.5	5	
Isolation (RFIN to RF1 - RF4)	23 - 30 GHz	30	35		dB
Return Loss [1]	"On State"	23 - 30 GHz	10		dB
Return Loss [2]	"Off State"	23 - 30 GHz	4		dB
Input Power for 0.1 dB Compression	23 - 30 GHz		17		dBm
Input Third Order Intercept (Two-Tone Input Power= 0 dBm Each Tone)	23 - 30 GHz		30		dBm
Switching Characteristics	tRISE, tFALL (10/90% RF)	23 - 30 GHz	15		ns
	tON, tOFF (50% CTL to 10/90% RF)	23 - 30 GHz	53		ns

[1] Return loss with switch path in insertion loss state.

[2] Return loss with switch path in isolation state.



GaAs MMIC SP4T REFLECTIVE SWITCH, 23 - 30 GHz

Insertion Loss RFIN to RF1, RF4 vs. Temperature

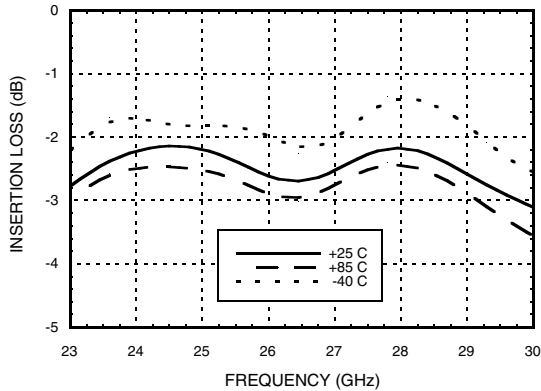

Insertion Loss RFIN to RF2, RF3 vs. Temperature

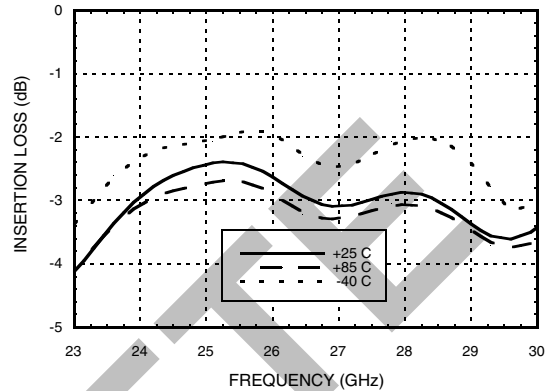

Isolation [1]

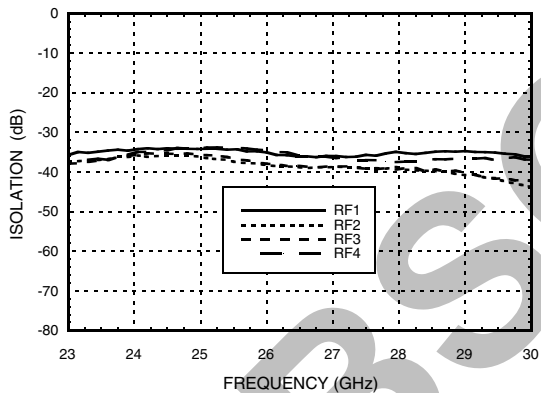

Return Loss On State [2]

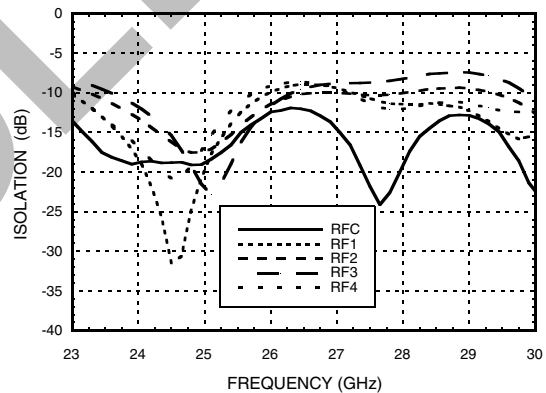

Return Loss Off State

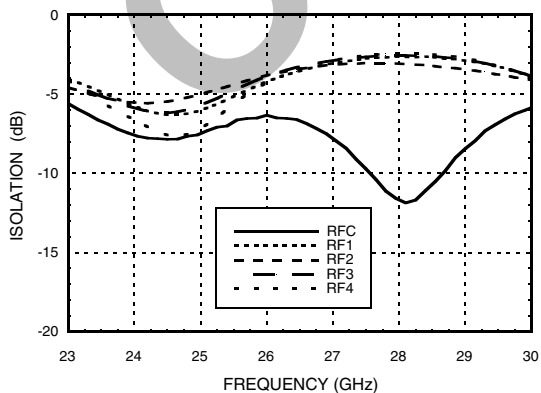

0.1 dB Input Compression Point

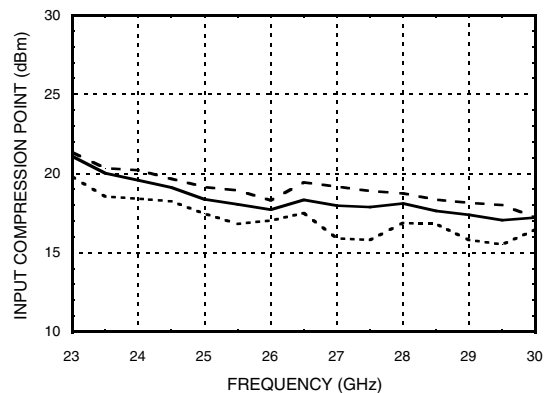

[1] Return loss with switch path in insertion loss state.
 [2] Return loss with switch path in isolation state.

**GaAs MMIC SP4T REFLECTIVE
SWITCH, 23 - 30 GHz**
Absolute Maximum Ratings

Control Voltage Range (VC1, VC2, VC3, VC4)	<+2V and >-5V
Maximum Input Power	2W (33 dBm)
Channel Temperature	150 °C
Thermal Resistance Channel to die bottom (Insertion Loss Path)	12 °C/W
Storage Temperature	-65 to +150 °C
Operating Temperature	-40 to +85 °C
ESD Sensitivity (HBM)	Class 1B



**ELECTROSTATIC SENSITIVE DEVICE
OBSERVE HANDLING PRECAUTIONS**

Bias Voltage & Current

VC (V)	IC (µA)
VC1 = -3V	IC1 <10 µA
VC2 = -3V	IC2 <10 µA
VC3 = -3V	IC3 <10 µA
VC4 = -3V	IC4 <10 µA

Truth Table

VC1	VC2	VC3	VC4	RFIN to:
-3V	0V	0V	0V	RF1
0V	-3V	0V	0V	RF2
0V	0V	-3V	0V	RF3
0V	0V	0V	-3V	RF4

Control Voltages

State	Bias Condition
Low	+1V to -0.25V
High	-2.7V to -5V, < 10 µA

OBSOLETE



**GaAs MMIC SP4T REFLECTIVE
SWITCH, 23 - 30 GHz**

Outline Drawing

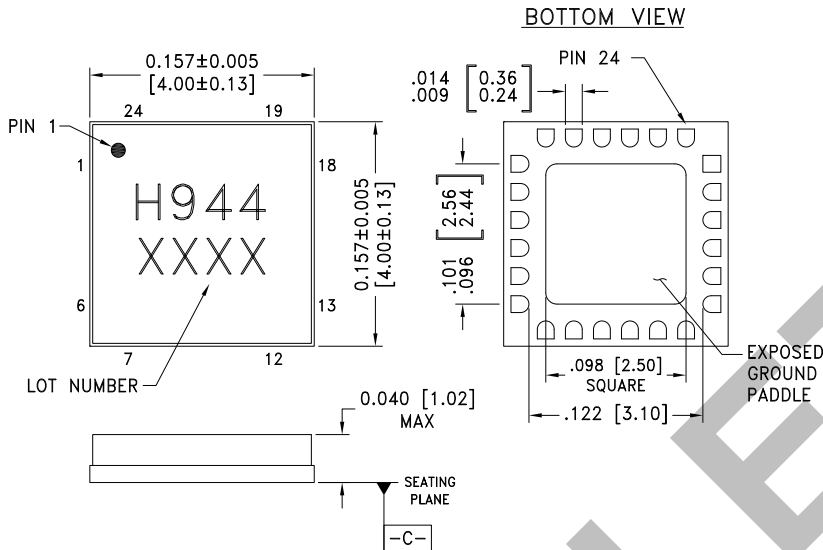

NOTES:

1. PACKAGE BODY MATERIAL: ALUMINA
2. LEAD AND GROUND PADDLE PLATING: 30-80 MICROINCHES GOLD OVER 50 MICROINCHES MINIMUM NICKEL.
3. DIMENSIONS ARE IN INCHES [MILLIMETERS].
4. LEAD SPACING TOLERANCE IS NON-CUMULATIVE
5. PACKAGE WARP SHALL NOT EXCEED 0.05mm DATUM -C-
6. ALL GROUND LEADS AND GROUND PADDLE MUST BE SOLDERED TO PCB RF GROUND.



Package Information

Part Number	Package Body Material	Lead Finish	MSL Rating	Package Marking ^[2]
HMC944LC4	Alumina, White	Gold over Nickel	MSL3 ^[1]	H944 XXXX

[1] Max peak reflow temperature of 260 °C

[2] 4-Digit lot number XXXX

**GaAs MMIC SP4T REFLECTIVE
SWITCH, 23 - 30 GHz**
Pin Descriptions

Pin Number	Function	Description	Interface Schematic
1, 2, 6, 8, 23	N/C	These pins are not connected internally; however, all data shown herein was measured with these pins connected to RF/DC ground externally.	
3, 5, 9, 11, 13, 15, 16, 18, 20, 22	GND	These pins and the exposed ground paddle must be connected to RF/DC ground.	
4, 10, 14, 17, 21	RIN, RF1, RF2, RF3, RF4	These pads are DC coupled (to GND) and matched to 50 Ohms.	
7, 12, 19, 24	VC1, VC2, VC3, VC4	See Truth Table	

OBSOLETE

**GaAs MMIC SP4T REFLECTIVE
SWITCH, 23 - 30 GHz**



Evaluation PCB

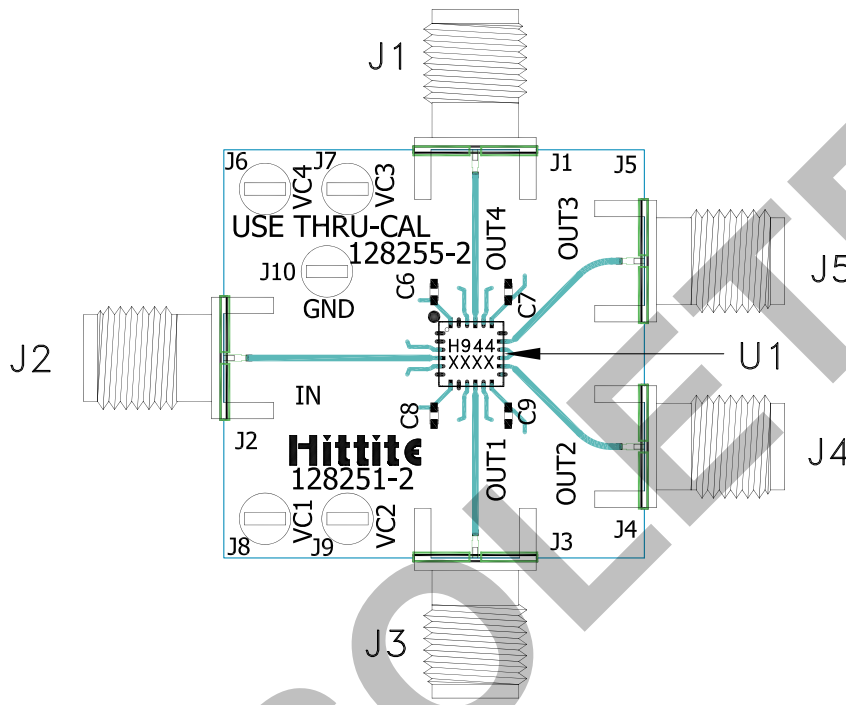

List of Materials for Evaluation PCB 128253 [1]

Item	Description
J1 - J5	PCB Mount K Connector
C6 - C9	1000 pF Capacitor, 0402 Pkg.
U1	HMC944LC4 Switch
PCB [2]	128251 Evaluation PCB

[1] Reference this number when ordering complete evaluation PCB

[2] Circuit Board Material: Rogers 4350 or Arlon FR4

The circuit board used in the application should use RF circuit design techniques. Signal lines should have 50 Ohm impedance while the package ground leads and exposed paddle should be connected directly to the ground plane similar to that shown. A sufficient number of via holes should be used to connect the top and bottom ground planes. The evaluation board should be mounted to an appropriate heat sink. The evaluation circuit board shown is available from Hittite upon request.