



Chipsmall Limited consists of a professional team with an average of over 10 year of expertise in the distribution of electronic components. Based in Hongkong, we have already established firm and mutual-benefit business relationships with customers from,Europe,America and south Asia,supplying obsolete and hard-to-find components to meet their specific needs.

With the principle of “Quality Parts,Customers Priority,Honest Operation,and Considerate Service”,our business mainly focus on the distribution of electronic components. Line cards we deal with include Microchip,ALPS,ROHM,Xilinx,Pulse,ON,Everlight and Freescale. Main products comprise IC,Modules,Potentiometer,IC Socket,Relay,Connector.Our parts cover such applications as commercial,industrial, and automotives areas.

We are looking forward to setting up business relationship with you and hope to provide you with the best service and solution. Let us make a better world for our industry!



Contact us

Tel: +86-755-8981 8866 Fax: +86-755-8427 6832

Email & Skype: info@chipsmall.com Web: www.chipsmall.com

Address: A1208, Overseas Decoration Building, #122 Zhenhua RD., Futian, Shenzhen, China





GaAs MMIC I/Q DOWNCONVERTER 21 - 24 GHz

Typical Applications

The HMC967LP4E is ideal for:

- Point-to-Point and Point-to-Multi-Point Radio
- Military Radar, EW & ELINT
- Satellite Communications

Features

- Conversion Gain: 15 dB
- Image Rejection: 25 dBc
- 2 LO to RF Isolation: 40 dB
- Noise Figure: 2.5 dB
- Input IP3: 1 dBm
- 24 Lead 4 x 4 mm SMT Package: 16 mm²

Functional Diagram

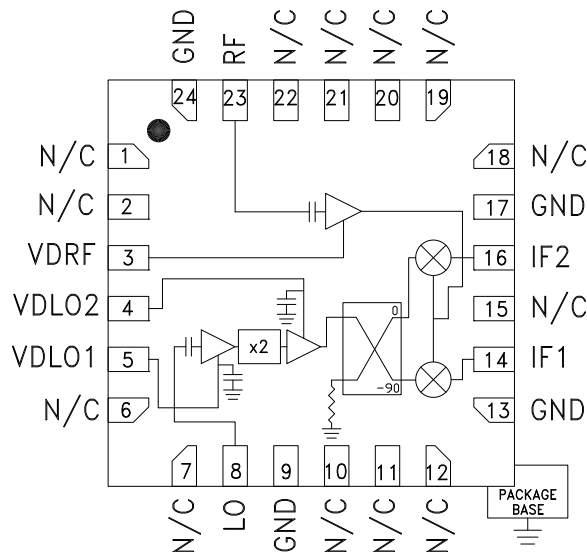

General Description

The HMC967LP4E is a compact GaAs MMIC I/Q downconverter in a leadless RoHS compliant SMT package. This device provides a small signal conversion gain of 15 dB with a noise figure of 2.5 dB and 25 dBc of image rejection across the frequency band. The HMC967LP4E utilizes an LNA followed by an image reject mixer which is driven by an active x2 multiplier. The image reject mixer eliminates the need for a filter following the LNA, and removes thermal noise at the image frequency. I and Q mixer outputs are provided and an external 90° hybrid is needed to select the required sideband. The HMC967LP4E is a much smaller alternative to hybrid style image reject mixer downconverter assemblies, and is compatible with surface mount manufacturing techniques.

Electrical Specifications, $T_A = +25\text{ }^\circ\text{C}$, $IF = 1000\text{ MHz}$, $LO = +6\text{ dBm}$, $V_{dd} = 3.5\text{ Vdc USB}$ [1]

Parameter	Min.	Typ.	Max.	Units
Frequency Range, RF	21 - 24			GHz
Frequency Range, LO	8.8 - 13.5			GHz
Frequency Range, IF	DC - 3.5			GHz
Conversion Gain (As IRM)	11	15		dB
Noise Figure		2.5	3.5	dB
Image Rejection	15	25		dBc
1 dB Compression (Input)		-8.5		dBm
2 LO to RF Isolation	32	40		dB
2 LO to IF Isolation	14	20		dB
IP3 (Input)	-2	1		dBm
Amplitude Balance [2]		0.5		dB
Phase Balance [2]		-12		deg
Total Supply Current		170	210	mA

[1] Data taken as IRM with external IF 90° Hybrid

[2] Data taken without external 90° hybrid, IF = 500 MHz

Information furnished by Analog Devices is believed to be accurate and reliable. However, no responsibility is assumed by Analog Devices for its use, nor for any infringements of patents or other rights of third parties that may result from its use. Specifications subject to change without notice. No license is granted by implication or otherwise under any patent or patent rights of Analog Devices. Trademarks and registered trademarks are the property of their respective owners.

For price, delivery, and to place orders: Analog Devices, Inc., One Technology Way, P.O. Box 9106, Norwood, MA 02062-9106
Phone: 781-329-4700 • Order online at www.analog.com
Application Support: Phone: 1-800-ANALOG-D

HMC967* PRODUCT PAGE QUICK LINKS

Last Content Update: 02/23/2017

COMPARABLE PARTS

View a parametric search of comparable parts.

EVALUATION KITS

- HMC967LP4E Evaluation Board

DOCUMENTATION

Data Sheet

- HMC967 Data Sheet

REFERENCE MATERIALS

Quality Documentation

- Package/Assembly Qualification Test Report: LP4, LP4B, LP4C, LP4K (QTR: 2013-00487 REV: 04)
- Semiconductor Qualification Test Report: PHEMT-A (QTR: 2013-00267)

DESIGN RESOURCES

- HMC967 Material Declaration
- PCN-PDN Information
- Quality And Reliability
- Symbols and Footprints

DISCUSSIONS

View all HMC967 EngineerZone Discussions.

SAMPLE AND BUY

Visit the product page to see pricing options.

TECHNICAL SUPPORT

Submit a technical question or find your regional support number.

DOCUMENT FEEDBACK

Submit feedback for this data sheet.



**GAAS MMIC I/Q DOWNCONVERTER
21 - 24 GHz**

Data Taken As IRM With External IF 90° Hybrid, IF = 1000 MHz

Conversion Gain USB vs. Temperature

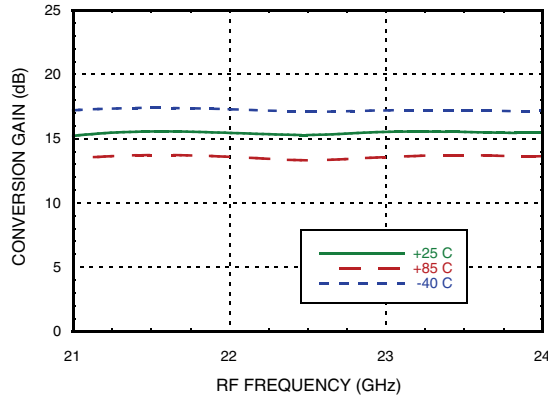

Conversion Gain USB vs. LO Drive

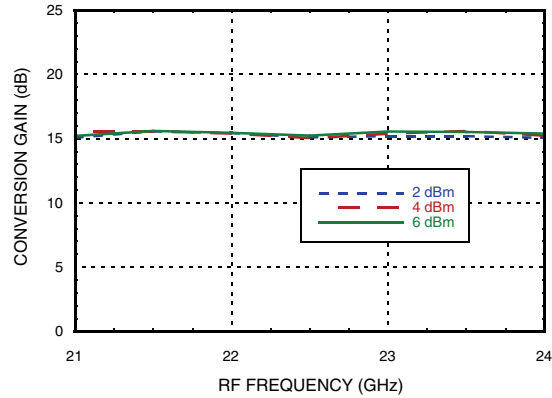
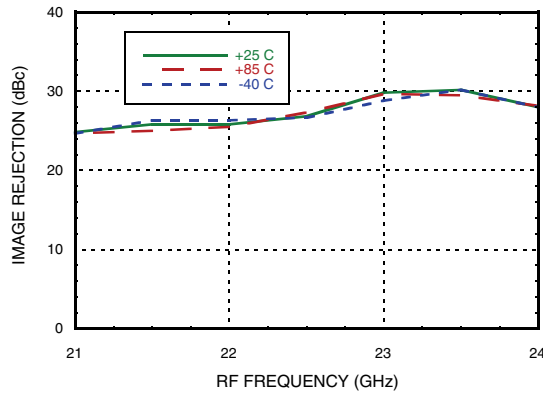
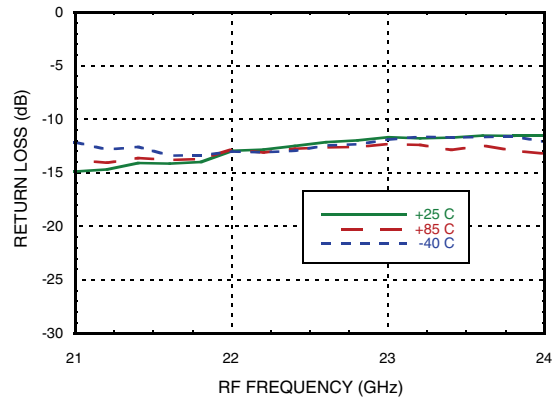

Image Rejection vs. Temperature



RF Return Loss vs. Temperature



LO Return Loss vs. Temperature

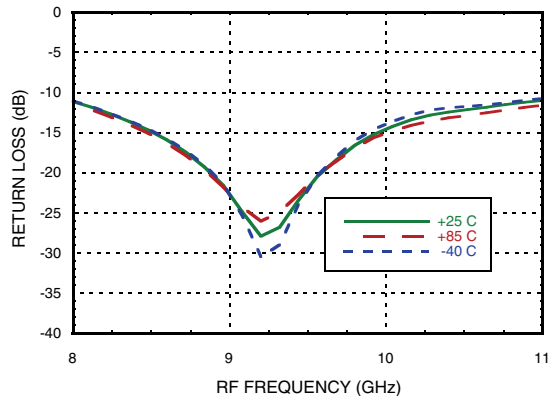

IF Return Loss [1]

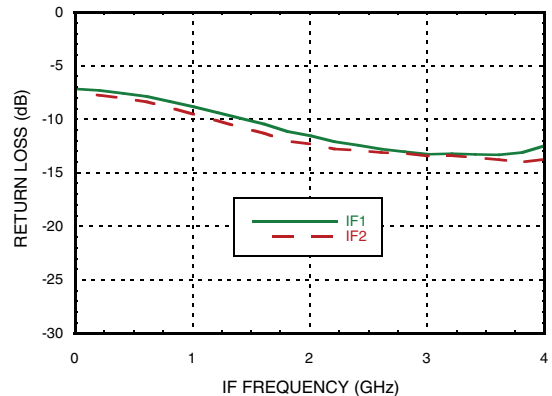

[1] Data taken without external 90° hybrid.



**GAAS MMIC I/Q DOWNCONVERTER
21 - 24 GHz**

Data Taken as IRM With External IF 90° Hybrid, IF = 1000 MHz

Isolations

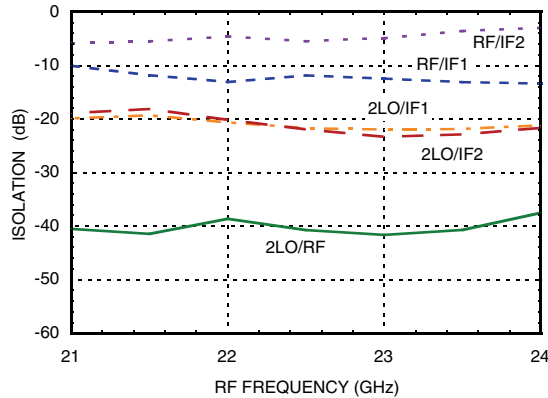

Input P1dB USB vs. Temperature

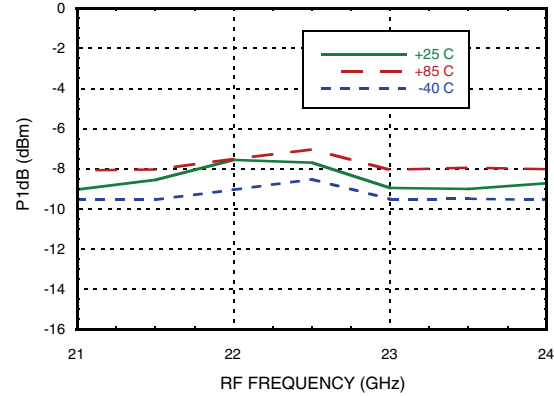

Input IP3, USB vs. Temperature

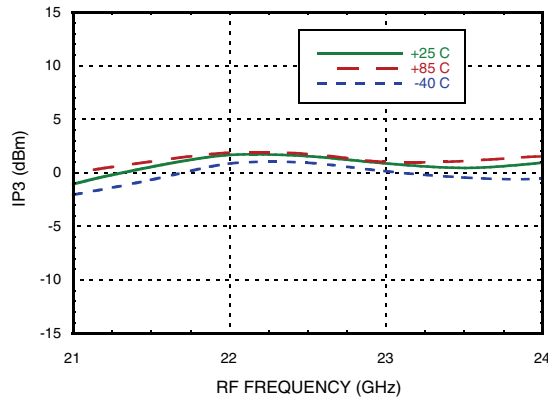

Input IP3, USB vs. LO Drive

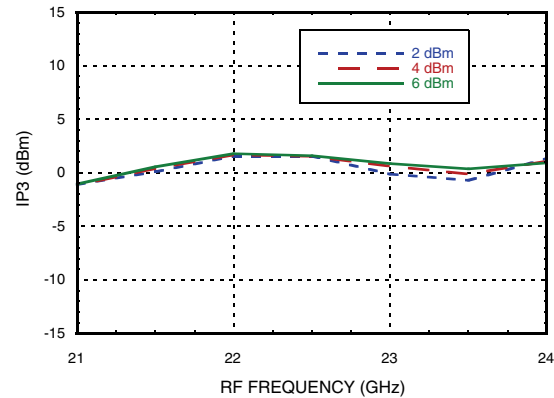

**Noise Figure vs. LO Drive,
LO Frequency = 8.25 GHz**

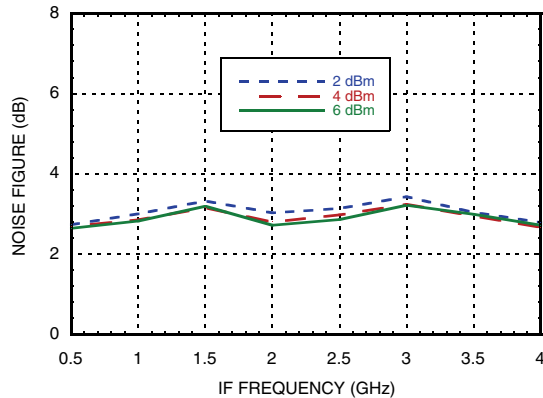

**Noise Figure vs. Temperature,
IF Frequency = 1000 MHz**

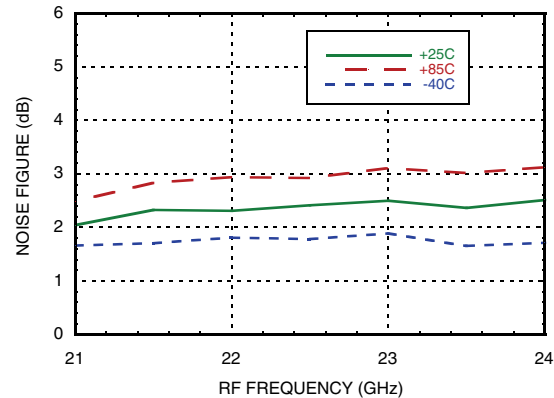

Information furnished by Analog Devices is believed to be accurate and reliable. However, no responsibility is assumed by Analog Devices for its use, nor for any infringements of patents or other rights of third parties that may result from its use. Specifications subject to change without notice. No license is granted by implication or otherwise under any patent or patent rights of Analog Devices. Trademarks and registered trademarks are the property of their respective owners.

For price, delivery, and to place orders: Analog Devices, Inc., One Technology Way, P.O. Box 9106, Norwood, MA 02062-9106 Phone: 781-329-4700 • Order online at www.analog.com Application Support: Phone: 1-800-ANALOG-D



**GAAS MMIC I/Q DOWNCONVERTER
21 - 24 GHz**

Quadrature Channel Data Taken Without IF 90° Hybrid, IF = 1000 MHz

IF Bandwidth [1]

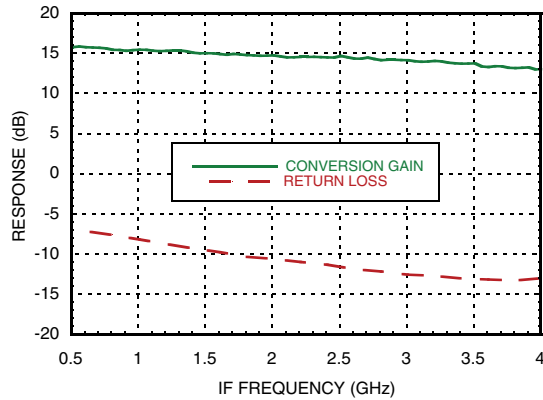

Amplitude Balance vs. LO Drive [2]

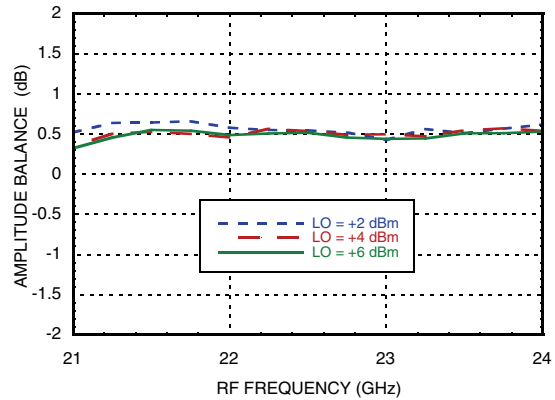

Phase Balance vs. LO Drive [1]

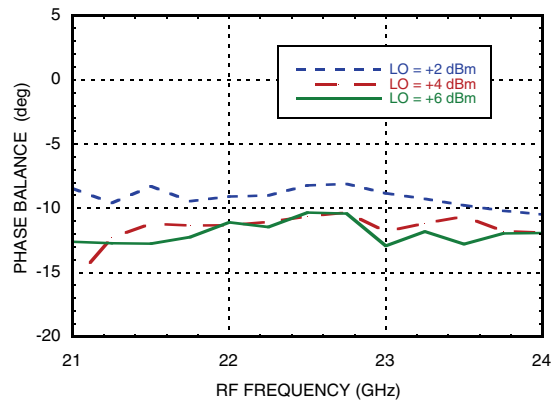

[1] Data taken with LO frequency fixed at 8.5 GHz and RF varied.

[2] Data taken with IF = 500 MHz



**GAAS MMIC I/Q DOWNCONVERTER
21 - 24 GHz**

Data Taken as IRM With External IF 90° Hybrid, IF = 1000 MHz

Conversion Gain, LSB vs. Temperature

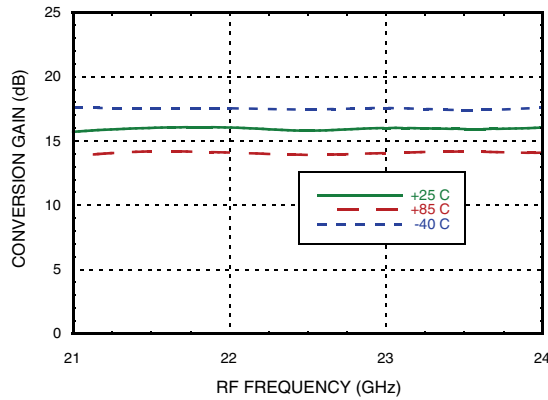

Conversion Gain, LSB vs. LO Drive

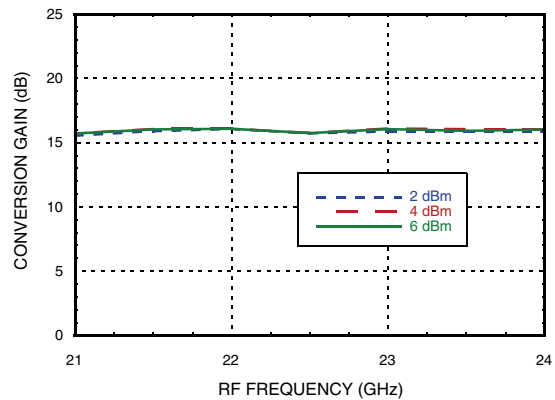
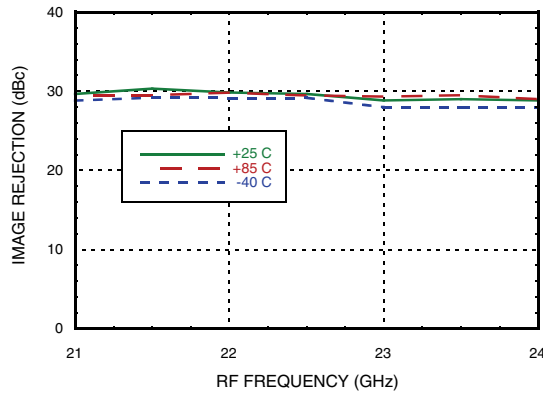
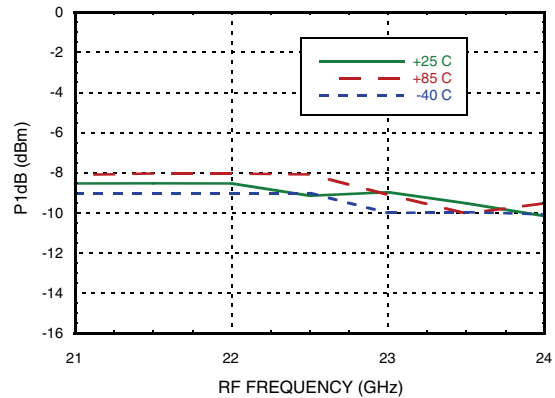

Image Rejection vs. Temperature



Input P1dB, LSB vs. Temperature



Input IP3, LSB vs. Temperature

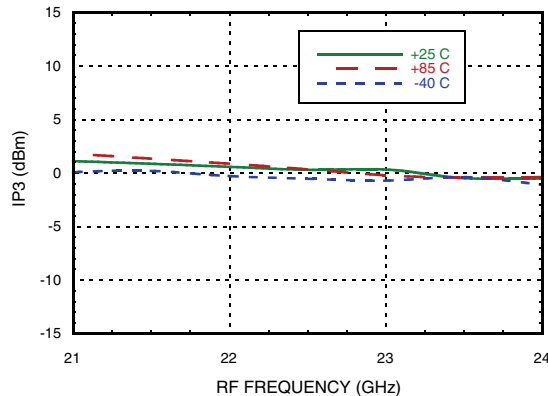

Input IP3, LSB vs. LO Drive

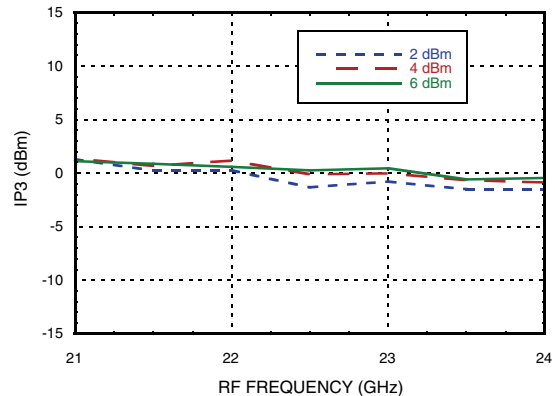

Information furnished by Analog Devices is believed to be accurate and reliable. However, no responsibility is assumed by Analog Devices for its use, nor for any infringements of patents or other rights of third parties that may result from its use. Specifications subject to change without notice. No license is granted by implication or otherwise under any patent or patent rights of Analog Devices. Trademarks and registered trademarks are the property of their respective owners.

For price, delivery, and to place orders: Analog Devices, Inc., One Technology Way, P.O. Box 9106, Norwood, MA 02062-9106 Phone: 781-329-4700 • Order online at www.analog.com Application Support: Phone: 1-800-ANALOG-D



**GAAS MMIC I/Q DOWNCONVERTER
21 - 24 GHz**

Data Taken as IRM With External IF 90° Hybrid, IF = 2000 MHz

Conversion Gain, USB vs. Temperature

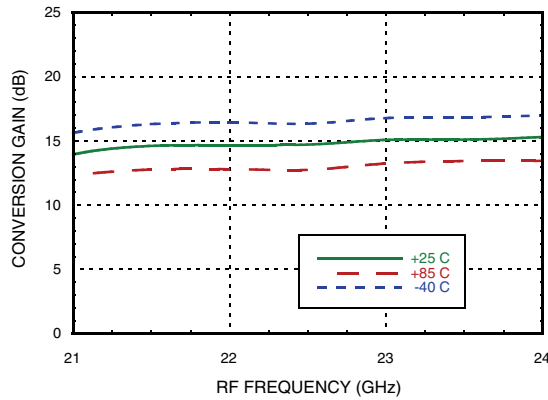

Conversion Gain, USB vs. LO Drive

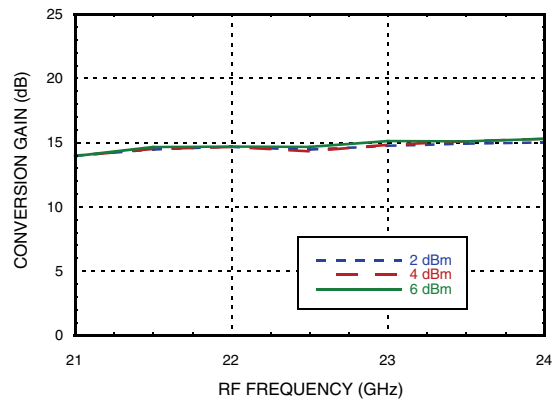
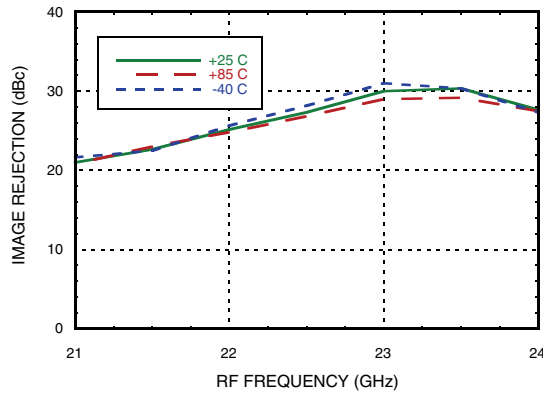
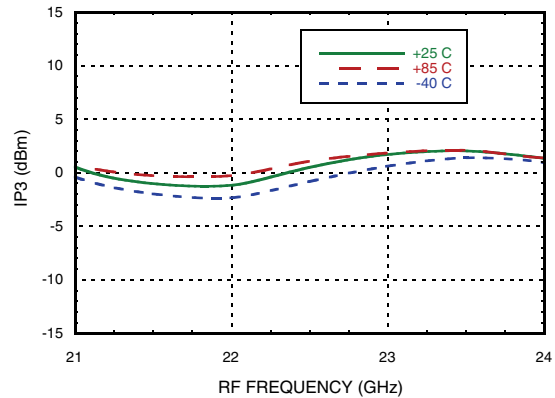

Image Rejection vs. Temperature



Input IP3, USB vs. Temperature



Input IP3, USB vs. LO Drive

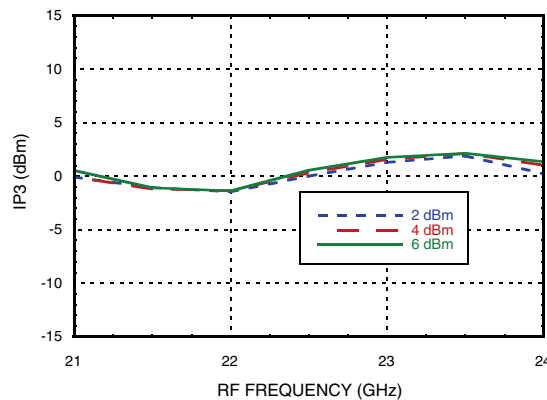

Information furnished by Analog Devices is believed to be accurate and reliable. However, no responsibility is assumed by Analog Devices for its use, nor for any infringements of patents or other rights of third parties that may result from its use. Specifications subject to change without notice. No license is granted by implication or otherwise under any patent or patent rights of Analog Devices. Trademarks and registered trademarks are the property of their respective owners.

For price, delivery, and to place orders: Analog Devices, Inc., One Technology Way, P.O. Box 9106, Norwood, MA 02062-9106 Phone: 781-329-4700 • Order online at www.analog.com Application Support: Phone: 1-800-ANALOG-D



**GAAS MMIC I/Q DOWNCONVERTER
21 - 24 GHz**

Data Taken as IRM With External IF 90° Hybrid, IF = 2000 MHz

Conversion Gain, LSB vs. Temperature

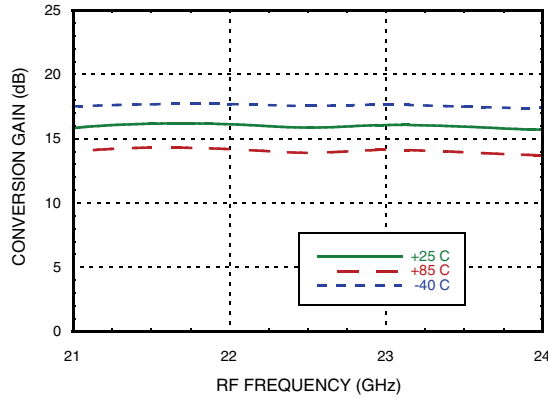

Conversion Gain, LSB vs. LO Drive

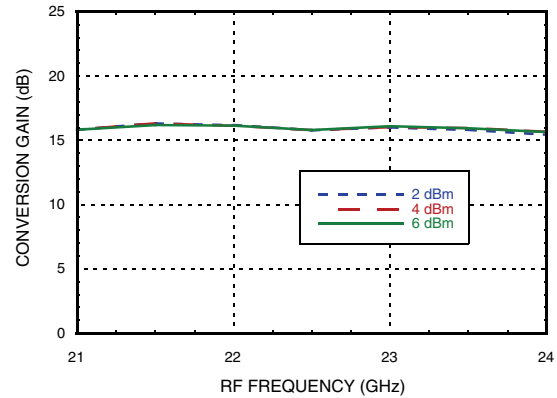
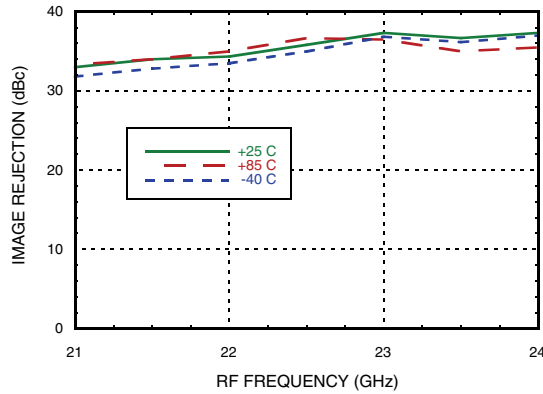
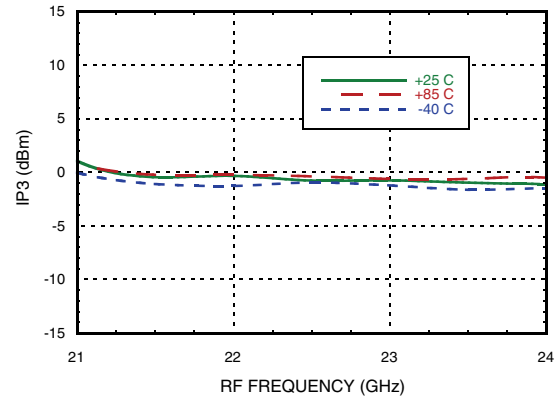

Image Rejection vs. Temperature



Input IP3, LSB vs. Temperature



Input IP3, LSB vs. LO Drive

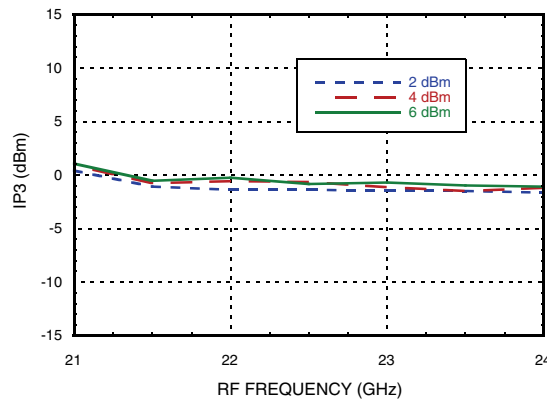

Information furnished by Analog Devices is believed to be accurate and reliable. However, no responsibility is assumed by Analog Devices for its use, nor for any infringements of patents or other rights of third parties that may result from its use. Specifications subject to change without notice. No license is granted by implication or otherwise under any patent or patent rights of Analog Devices. Trademarks and registered trademarks are the property of their respective owners.

For price, delivery, and to place orders: Analog Devices, Inc., One Technology Way, P.O. Box 9106, Norwood, MA 02062-9106 Phone: 781-329-4700 • Order online at www.analog.com Application Support: Phone: 1-800-ANALOG-D



**GAAS MMIC I/Q DOWNCONVERTER
21 - 24 GHz**

Data Taken as IRM With External IF 90° Hybrid, IF = 3300 MHz

Conversion Gain, USB vs. Temperature

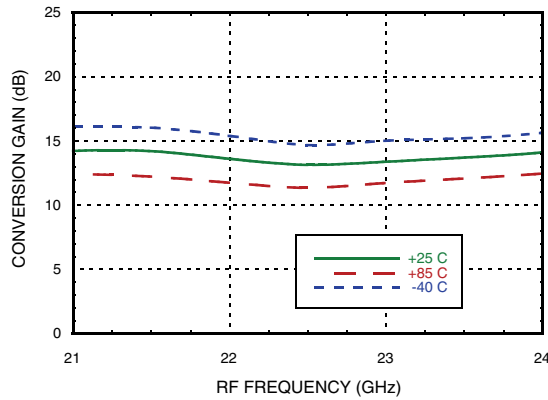

Conversion Gain, USB vs. LO Drive

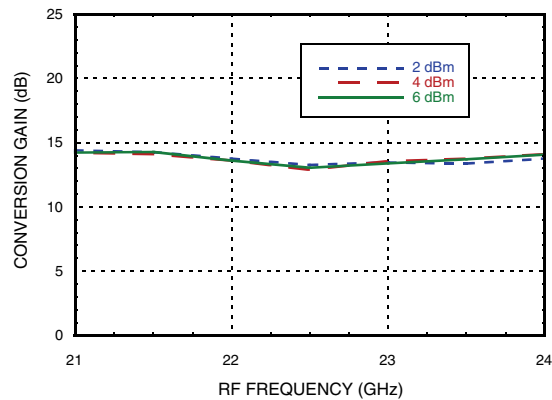
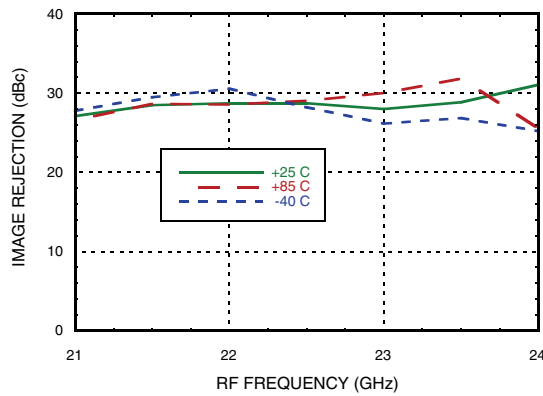
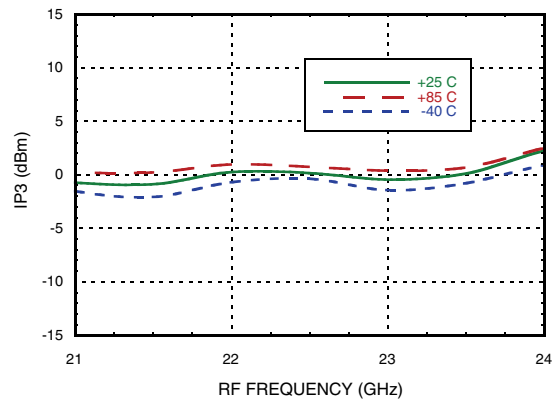

Image Rejection vs. Temperature



Input IP3, USB vs. Temperature



Input IP3, USB vs. LO Drive

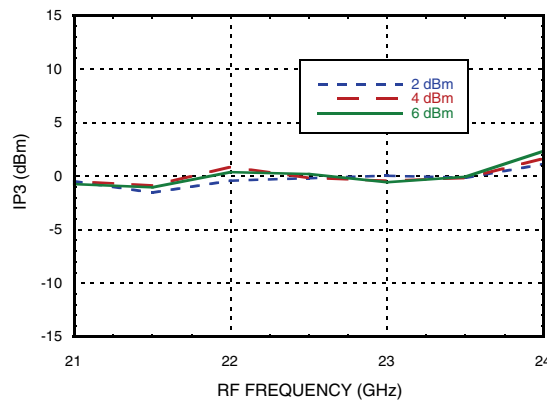

Information furnished by Analog Devices is believed to be accurate and reliable. However, no responsibility is assumed by Analog Devices for its use, nor for any infringements of patents or other rights of third parties that may result from its use. Specifications subject to change without notice. No license is granted by implication or otherwise under any patent or patent rights of Analog Devices. Trademarks and registered trademarks are the property of their respective owners.

For price, delivery, and to place orders: Analog Devices, Inc., One Technology Way, P.O. Box 9106, Norwood, MA 02062-9106 Phone: 781-329-4700 • Order online at www.analog.com Application Support: Phone: 1-800-ANALOG-D



**GAAS MMIC I/Q DOWNCONVERTER
21 - 24 GHz**

Data Taken as IRM With External IF 90° Hybrid, IF = 3300 MHz

Conversion Gain, LSB vs. Temperature

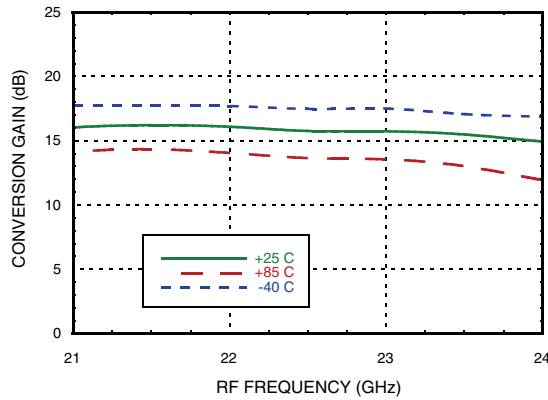

Conversion Gain, LSB vs. LO Drive

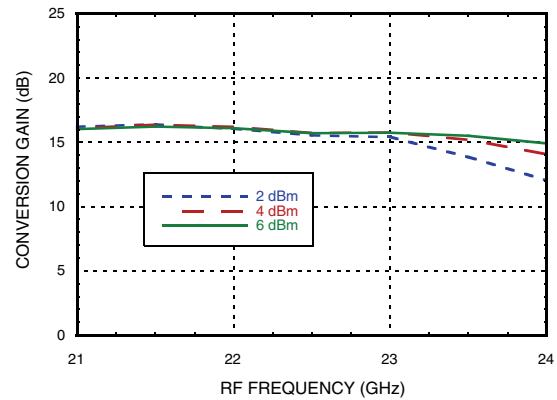
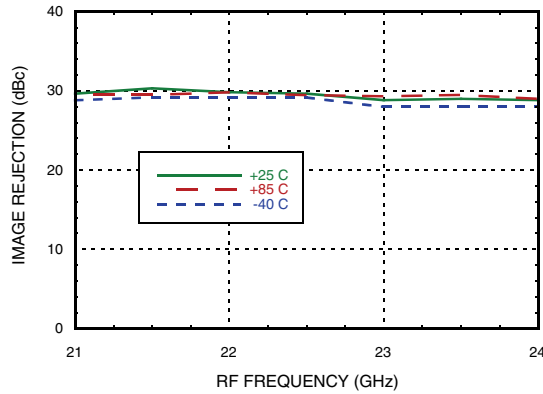
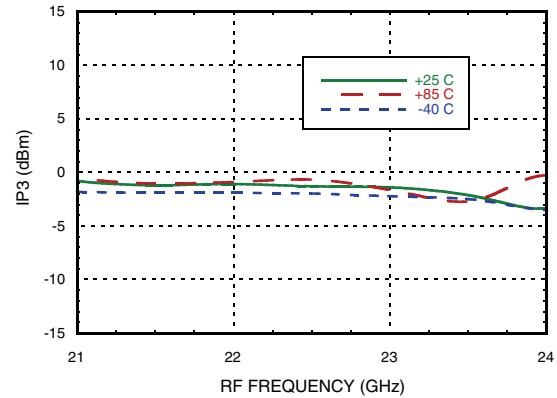

Image Rejection vs. Temperature



Input IP3, LSB vs. Temperature



Input IP3, LSB vs. LO Drive

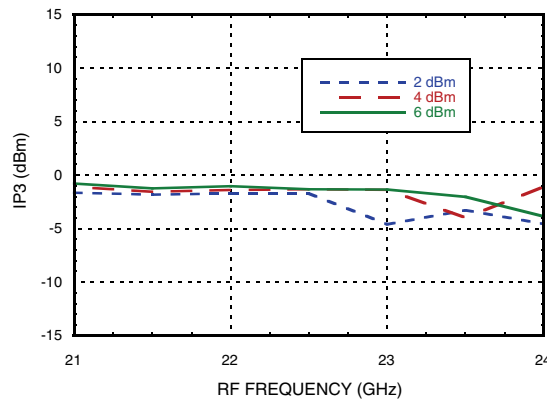

Information furnished by Analog Devices is believed to be accurate and reliable. However, no responsibility is assumed by Analog Devices for its use, nor for any infringements of patents or other rights of third parties that may result from its use. Specifications subject to change without notice. No license is granted by implication or otherwise under any patent or patent rights of Analog Devices. Trademarks and registered trademarks are the property of their respective owners.

For price, delivery, and to place orders: Analog Devices, Inc., One Technology Way, P.O. Box 9106, Norwood, MA 02062-9106 Phone: 781-329-4700 • Order online at www.analog.com Application Support: Phone: 1-800-ANALOG-D



GAAS MMIC I/Q DOWNCONVERTER 21 - 24 GHz

MxN Spurious Outputs

mRF	nLO				
	0	1	2	3	4
0	x	-24.2	-4.3	-29.3	-34.4
1	-25.6	-40.6	0	-43.8	-34.6
2	-67.4	-86.9	-57.4	-66.2	-45.3
3	x	x	-96.6	-102.8	-71.3
4	x	x	x	x	-108.8

RF = 22 GHz @ -20 dBm
LO = 10.5 GHz @ +4 dBm
Data taken without IF hybrid
All values in dBc below IF power level (1RF -2LO = 1 GHz)

Absolute Maximum Ratings

RF	+2 dBm
LO Drive	+10 dBm
Vdd	4V
Channel Temperature	175 °C
Continuous P _{diss} (T=85°C) (derate 12.5 mW/°C above 85°C)	1.13 W
Thermal Resistance (R _{TH}) (channel to package bottom)	79.6 °C/W
Storage Temperature	-65 to +150 °C
Operating Temperature	-55 to +85 °C
ESD Sensitivity (HBM)	Class 1A



ELECTROSTATIC SENSITIVE DEVICE
OBSERVE HANDLING PRECAUTIONS

Outline Drawing

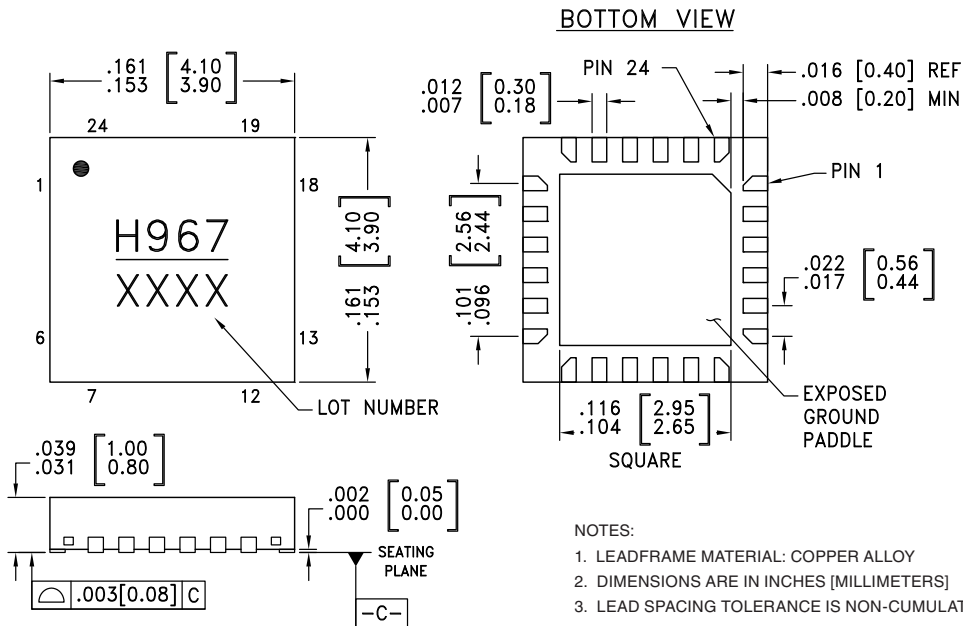

NOTES:

- LEADFRAME MATERIAL: COPPER ALLOY
- DIMENSIONS ARE IN INCHES [MILLIMETERS]
- LEAD SPACING TOLERANCE IS NON-CUMULATIVE
- PAD BURR LENGTH SHALL BE 0.15 mm MAXIMUM.
PAD BURR HEIGHT SHALL BE 0.05 mm MAXIMUM.
- PACKAGE WARP SHALL NOT EXCEED 0.05 mm.
- ALL GROUND LEADS AND GROUND PADDLE MUST BE SOLDERED TO PCB RF GROUND.
- REFER TO HITTITE APPLICATION NOTE FOR SUGGESTED LAND PATTERN.

Package Information

Part Number	Package Body Material	Lead Finish	MSL Rating	Package Marking ^[1]
HMC967LP4E	RoHS-compliant Low Stress Injection Molded Plastic	100% matte Sn	MSL1 ^[2]	H967 XXXX

[1] 4-Digit lot number XXXX

[2] Max peak reflow temperature of 260 °C



**GAAS MMIC I/Q DOWNCONVERTER
21 - 24 GHz**

Pin Descriptions

Pin Number	Function	Description	Interface Schematic
1, 2, 6, 7, 10 - 12, 15, 18 - 22	N/C	The pins are not connected internally; however, all data shown herein was measured with these pins connected to RF/DC ground externally.	
3	VDRF	Power supply for RF LNA.	
4	VDLO2	Power supply for second stage of LO amplifier.	VDLO2
5	VDLO1	Power supply for first stage of LO amplifier.	VDLO1
8	LO	This pin is AC coupled and matched to 50 Ohms.	LO
9, 13, 17, 24	GND	These pins and the exposed ground paddle must be connected to RF/DC ground.	GND
16	IF2	This pin is DC coupled. For applications not requiring operation to DC this port should be DC blocked externally using a series capacitor whose value has been chosen to pass the necessary frequency range. For operation to DC, this pin must not sink / source more than 3 mA of current or part non-function and possible failure will result.	
14	IF1		
23	RF	This pin is AC coupled and matched to 50 Ohms	RF

Typical Application Circuit

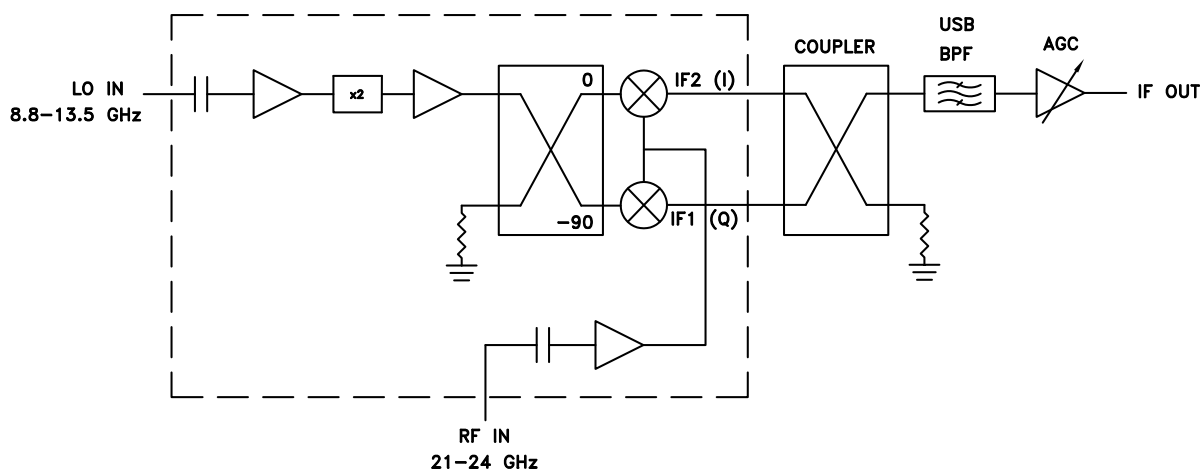

Information furnished by Analog Devices is believed to be accurate and reliable. However, no responsibility is assumed by Analog Devices for its use, nor for any infringements of patents or other rights of third parties that may result from its use. Specifications subject to change without notice. No license is granted by implication or otherwise under any patent or patent rights of Analog Devices. Trademarks and registered trademarks are the property of their respective owners.

For price, delivery, and to place orders: Analog Devices, Inc., One Technology Way, P.O. Box 9106, Norwood, MA 02062-9106 Phone: 781-329-4700 • Order online at www.analog.com Application Support: Phone: 1-800-ANALOG-D



Evaluation PCB

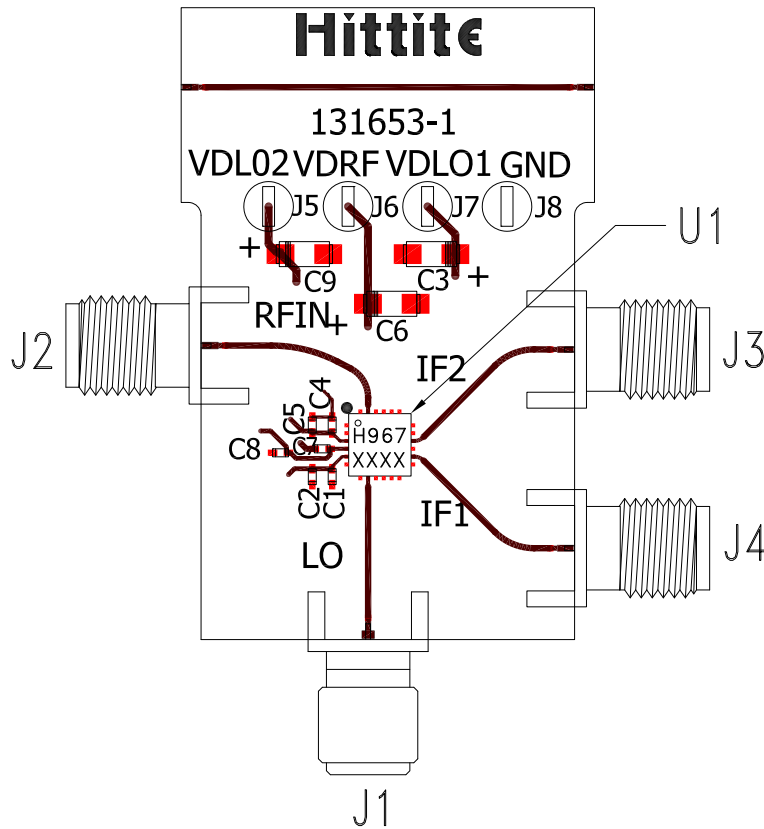

List of Materials for Evaluation PCB 131656 [1]

Item	Description
J1	PCB Mount SMA RF Connector, SRI
J2, J3	PCB Mount K Connector, SRI
J5 - J8	DC Pin
C1, C4, C7	100 pF Capacitor, 0402 Pkg.
C2, C5, C8	10 nF Capacitor, 0402 Pkg.
C3, C6, C9	4.7 μF Capacitor, Case A Pkg.
U1	HMC967LP4E
PCB [2]	161653 Evaluation Board

[1] Reference this number when ordering complete evaluation PCB

[2] Circuit Board Material: Rogers 4350

The circuit board used in the application should use RF circuit design techniques. Signal lines should have 50 Ohm impedance while the package ground leads and exposed paddle should be connected directly to the ground plane similar to that shown. A sufficient number of via holes should be used to connect the top and bottom ground planes. The evaluation circuit board shown is available from Hittite upon request.