



Chipsmall Limited consists of a professional team with an average of over 10 year of expertise in the distribution of electronic components. Based in Hongkong, we have already established firm and mutual-benefit business relationships with customers from,Europe,America and south Asia,supplying obsolete and hard-to-find components to meet their specific needs.

With the principle of “Quality Parts,Customers Priority,Honest Operation,and Considerate Service”,our business mainly focus on the distribution of electronic components. Line cards we deal with include Microchip,ALPS,ROHM,Xilinx,Pulse,ON,Everlight and Freescale. Main products comprise IC,Modules,Potentiometer,IC Socket,Relay,Connector.Our parts cover such applications as commercial,industrial, and automotives areas.

We are looking forward to setting up business relationship with you and hope to provide you with the best service and solution. Let us make a better world for our industry!



Contact us

Tel: +86-755-8981 8866 Fax: +86-755-8427 6832

Email & Skype: info@chipsmall.com Web: www.chipsmall.com

Address: A1208, Overseas Decoration Building, #122 Zhenhua RD., Futian, Shenzhen, China





GaAs MMIC VOLTAGE - VARIABLE ATTENUATOR, 10 - 40 GHz

Typical Applications

The HMC985LP4KE is ideal for:

- Point-to-Point Radio
- VSAT Radio
- Test Instrumentation
- Microwave Sensors
- Military, ECM & Radar

Features

- Wide Bandwidth: 10 - 40 GHz
- Excellent Linearity: +32 dB Input IP3
- Wide Attenuation Range: 35 dB
- No External Matching
- 24 Lead 4x4 mm SMT Package: 16 mm²

General Description

The HMC985LP4KE is an absorptive Voltage Variable Attenuator (VVA) which operates from 10 - 40 GHz and is ideal in designs where an analog DC control signal must be used to control RF signal levels over a 35 dB dynamic range. It features two shunt-type attenuators which are controlled by two analog voltages, Vctl1 and Vctl2. Optimum linearity performance of the attenuator is achieved by first varying Vctl1 of the first attenuation stage from -3V to 0V with Vctl2 fixed at -3V. The control voltage of the second attenuation stage, Vctl2, should then be varied from -3V to 0V with Vctl1 fixed at 0V.

if the Vctl1 and Vctl2 pins are connected together it is possible to achieve the full analog attenuation range with only a small degradation in input IP3 performance. Applications include AGC circuits and temperature compensation of multiple gain stages in microwave point-to-point and VSAT radios.

Functional Diagram

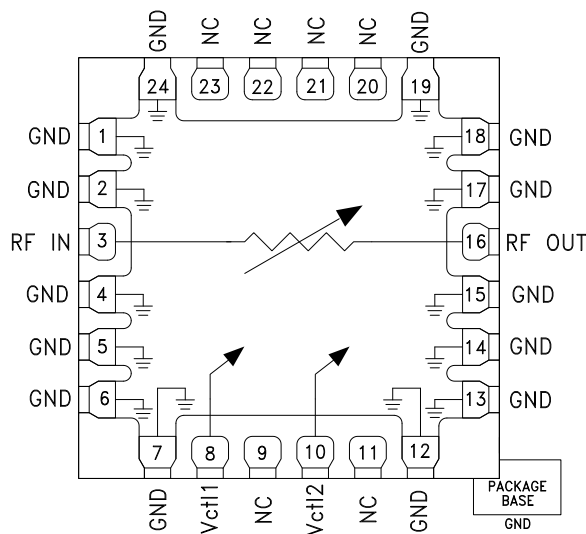

Electrical Specifications, $T_A = +25\text{ }^\circ\text{C}$, Test Condition $V_{ctl1} = V_{ctl2}$

| Parameter | Frequency | Min. | Typ. | Max. | Units |
|--|-------------|------|------|------|-------|
| Insertion Loss [1] | 10 - 20 GHz | | 3 | 3.5 | dB |
| | 20 - 30 GHz | | 3 | 4 | dB |
| | 30 - 40 GHz | | 3.5 | 4.5 | dB |
| Attenuation Range | 10 - 20 GHz | 25 | 30 | | dB |
| | 20 - 30 GHz | 30 | 35 | | dB |
| | 30 - 40 GHz | 35 | 40 | | dB |
| Input Return Loss | 10 - 40 GHz | | 13 | | dB |
| Output Return Loss | 10 - 40 GHz | | 13 | | dB |
| Input Third Order Intercept (two-tone input Power = 10 dBm Each Tone) [2] | | | 33 | | dBm |

[1] Vctl1 = Vctl2 = -2.4V

[2] Vctl1 = Vctl2 = -2.0V worst case

HMC985* PRODUCT PAGE QUICK LINKS

Last Content Update: 02/23/2017

COMPARABLE PARTS

View a parametric search of comparable parts.

EVALUATION KITS

- HMC985LP4KE Evaluation Board

DOCUMENTATION

Data Sheet

- HMC985 Die Data Sheet
- HMC985LP4KE Data Sheet

TOOLS AND SIMULATIONS

- HMC985 S-Parameters

REFERENCE MATERIALS

Quality Documentation

- Package/Assembly Qualification Test Report: LP4, LP4B, LP4C, LP4K (QTR: 2013-00487 REV: 04)
- Semiconductor Qualification Test Report: MESFET-F (QTR: 2013-00247)

DESIGN RESOURCES

- HMC985 Material Declaration
- PCN-PDN Information
- Quality And Reliability
- Symbols and Footprints

DISCUSSIONS

View all HMC985 EngineerZone Discussions.

SAMPLE AND BUY

Visit the product page to see pricing options.

TECHNICAL SUPPORT

Submit a technical question or find your regional support number.

DOCUMENT FEEDBACK

Submit feedback for this data sheet.



GaAs MMIC VOLTAGE - VARIABLE ATTENUATOR, 10 - 40 GHz

Attenuation vs. Frequency over Vctrl1 = Variable, Vctrl2 = -3V

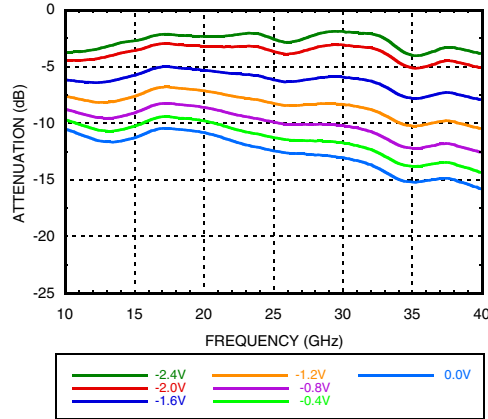

Attenuation vs. Frequency over Vctrl1 = 0V, Vctrl2 = Variable

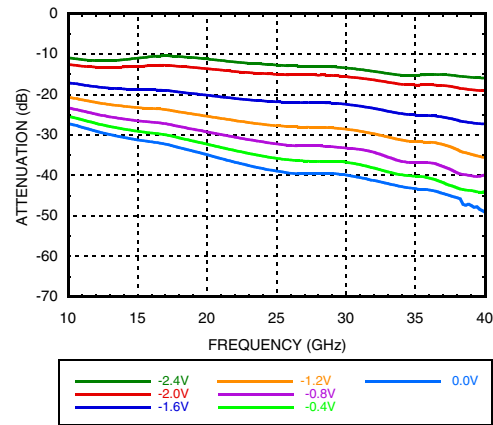

Attenuation vs. Vctrl1 Over Temperature @ 25 GHz, Vctrl2 = -3V

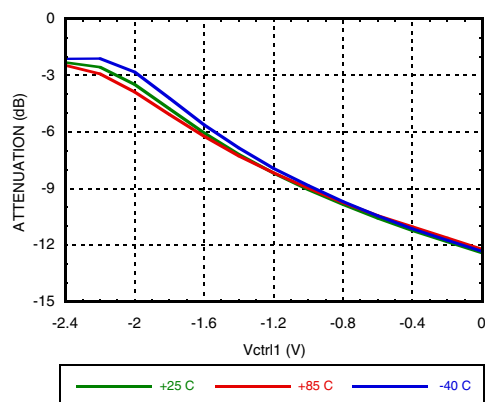

Attenuation vs. Vctrl2 Over Temperature @ 30 GHz, Vctrl1 = 0V

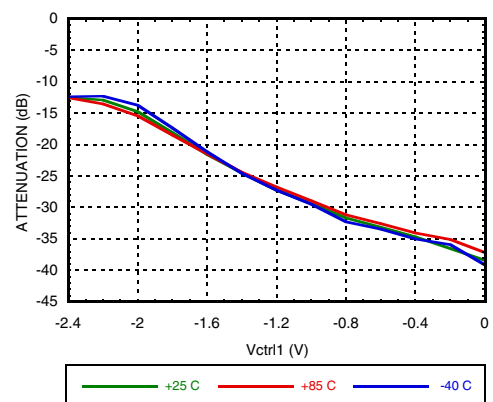

Attenuation vs. Pin @ 20 GHz over Vctrl1 Variable, Vctrl2 = -3V

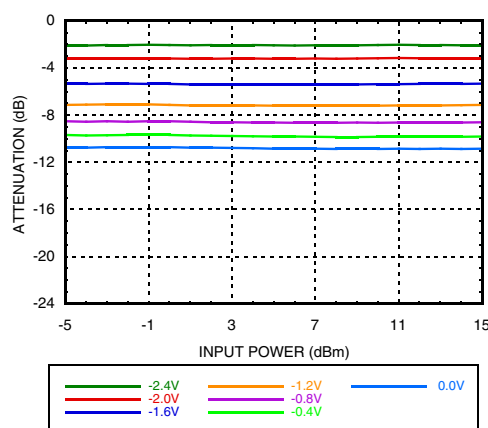

Attenuation vs. Pin @ 20 GHz over Vctrl2 Variable, Vctrl1 = 0V

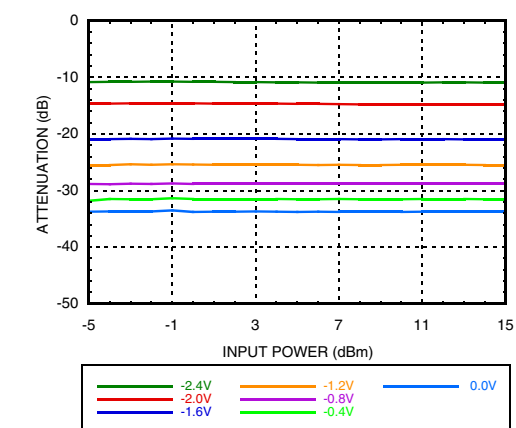

Information furnished by Analog Devices is believed to be accurate and reliable. However, no responsibility is assumed by Analog Devices for its use, nor for any infringements of patents or other rights of third parties that may result from its use. Specifications subject to change without notice. No license is granted by implication or otherwise under any patent or patent rights of Analog Devices. Trademarks and registered trademarks are the property of their respective owners.

For price, delivery, and to place orders: Analog Devices, Inc., One Technology Way, P.O. Box 9106, Norwood, MA 02062-9106 Phone: 781-329-4700 • Order online at www.analog.com Application Support: Phone: 1-800-ANALOG-D



GaAs MMIC VOLTAGE - VARIABLE ATTENUATOR, 10 - 40 GHz

Input Return Loss
Vctl1 = Variable, Vctl2 = -3V

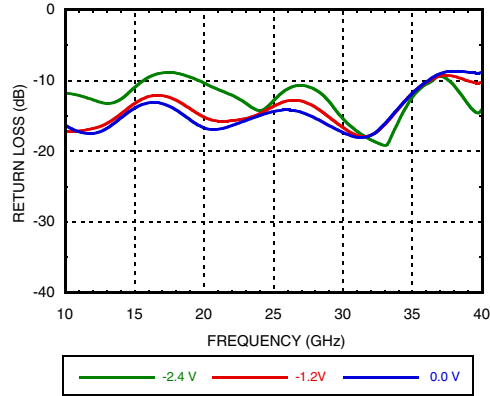

Input Return Loss
Vctl1 = 0V, Vctl2 = Variable

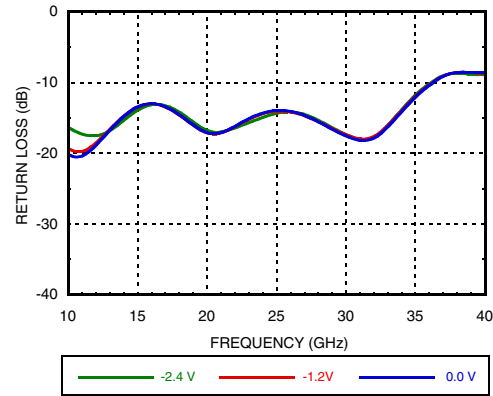

Output Return Loss
Vctl1 = Variable, Vctl2 = -3V

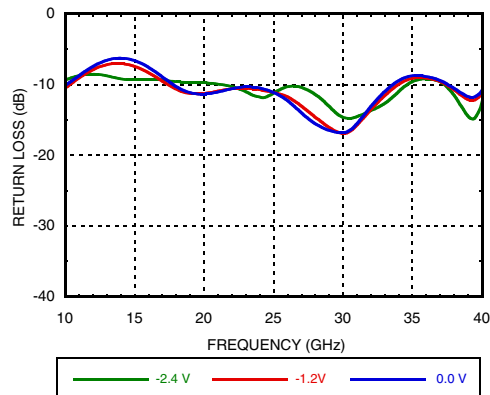

Output Return Loss
Vctl1 = 0V, Vctl2 = Variable

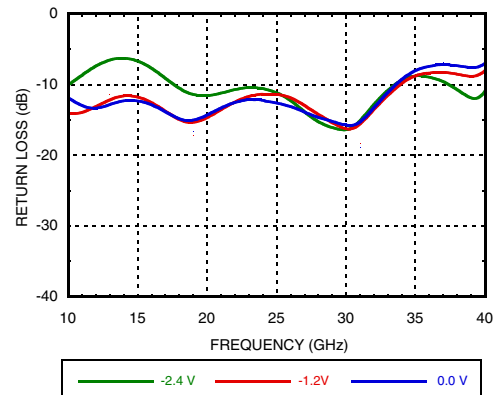

Input IP3 vs. Input Power @ 20 GHz
Vctl1 = Variable, Vctl2 = -3V

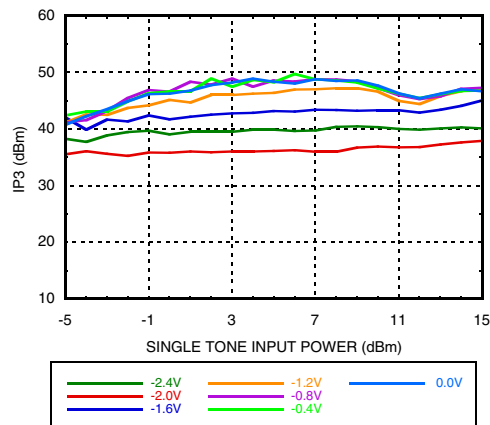

Input IP3 vs. Input Power Over Frequency
Vctl1 = -2V, Vctl2 = -3V [1]

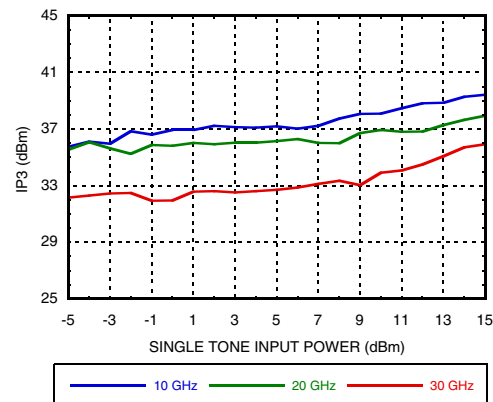

[1] Worst Case IP3



**GaAs MMIC VOLTAGE - VARIABLE
ATTENUATOR, 10 - 40 GHz**

**Input IP3 vs. Input Power Over Temperature
@ 20 GHz, Vctl1 = -2V, Vctl2 = -3V [1]**

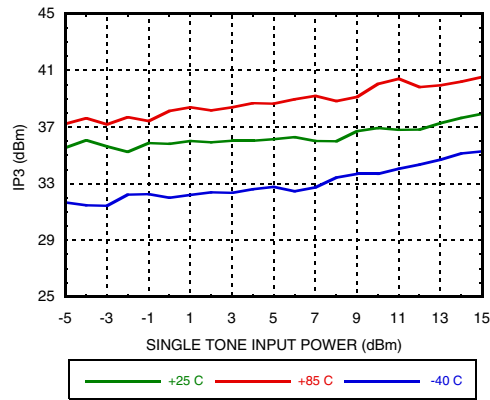

**Input IP3 vs. Input Power @ 20 GHz
Vctl2 = Variable, Vctl1 = 0V**

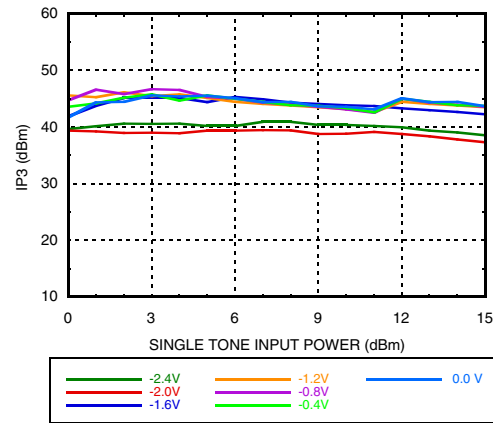

**Input IP3 vs. Input Power Over Frequency
Vctl2 = -2V, Vctl1 = 0V [1]**

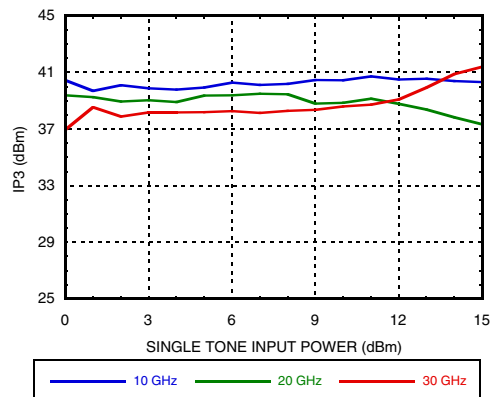

**Input IP3 vs Input Power over Temperature
@ 20 GHz, Vctl2 = -2V, Vctl1 = 0V [1]**

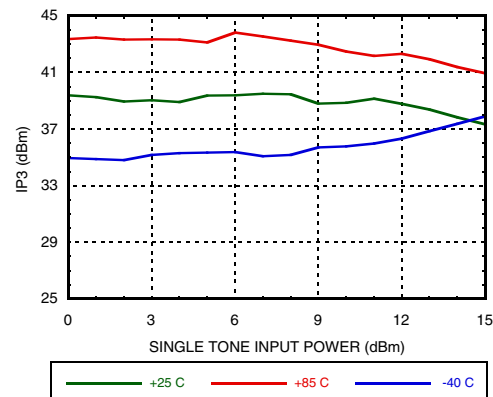

[1] Worst Case IP3



Attenuation vs Frequency Over Vctrl
Vctrl1 = Vctrl2

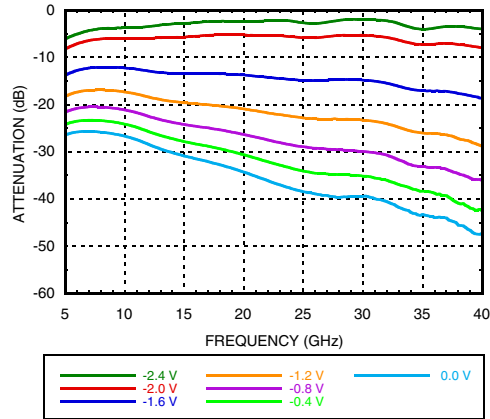

GaAs MMIC VOLTAGE - VARIABLE ATTENUATOR, 10 - 40 GHz

Attenuation vs. Vctrl Over Temperature
@ 20 GHz, Vctrl1 = Vctrl2

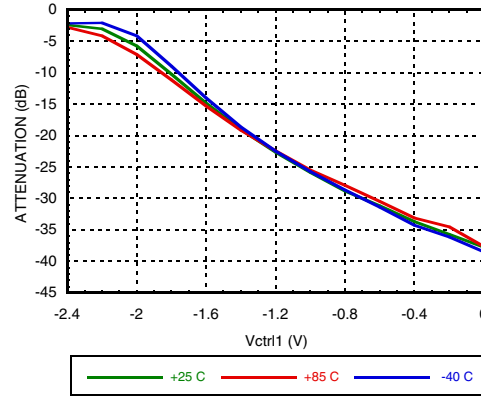

Attenuation vs. Pin @ 20 GHz Over Vctrl
Vctrl1 = Vctrl2

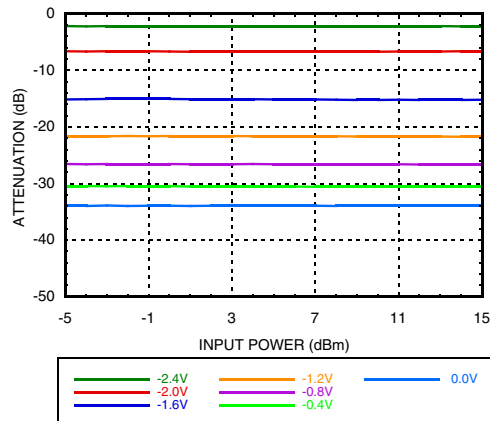

Input Return Loss, Vctrl1 = Vctrl2

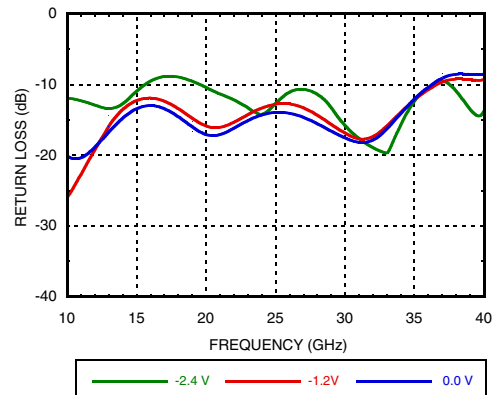

Output Return Loss, Vctrl1 = Vctrl2

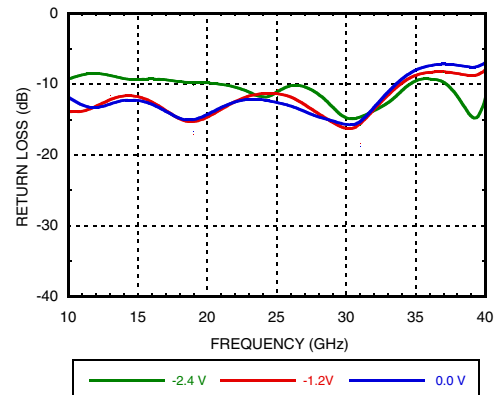

Input IP3 vs. Input Power Over Vctrl @ 20 GHz, Vctrl1 = Vctrl2

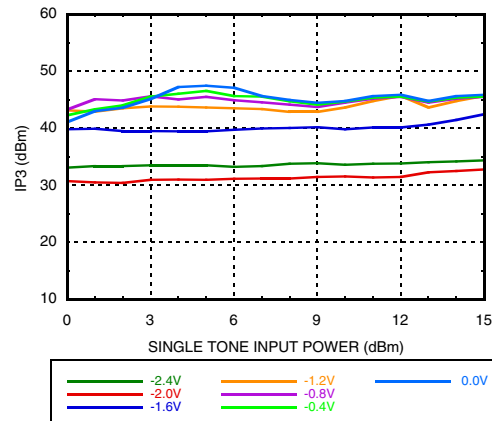

Information furnished by Analog Devices is believed to be accurate and reliable. However, no responsibility is assumed by Analog Devices for its use, nor for any infringements of patents or other rights of third parties that may result from its use. Specifications subject to change without notice. No license is granted by implication or otherwise under any patent or patent rights of Analog Devices. Trademarks and registered trademarks are the property of their respective owners.

For price, delivery, and to place orders: Analog Devices, Inc., One Technology Way, P.O. Box 9106, Norwood, MA 02062-9106 Phone: 781-329-4700 • Order online at www.analog.com Application Support: Phone: 1-800-ANALOG-D



**GaAs MMIC VOLTAGE - VARIABLE
ATTENUATOR, 10 - 40 GHz**

Input IP3 vs. Input Power Over Frequency
Vctl1 = Vctl2

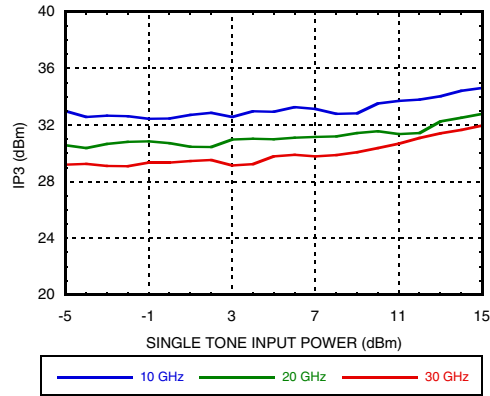

**Input IP3 vs. Input Power Over
Temperature @ 20 GHz Vctl1 = Vctl2**

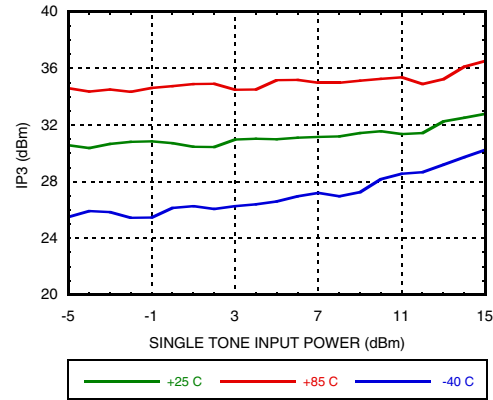



GaAs MMIC VOLTAGE - VARIABLE ATTENUATOR, 10 - 40 GHz

Absolute Maximum Ratings

| | |
|--|----------------------|
| Control Voltage | +1 to -5V |
| Input RF Power | 30 dBm |
| Maximum Junction Temperature | 165 °C |
| Thermal Resistance (R _{TH}) (junction to ground paddle) | 62 °C/W |
| Operating Temperature | -40°C to +85°C |
| Storage Temperature | -65°C to 125°C |
| ESD Sensitivity (HBM) | Class1A, passed 250V |



ELECTROSTATIC SENSITIVE DEVICE
OBSERVE HANDLING PRECAUTIONS

Outline Drawing

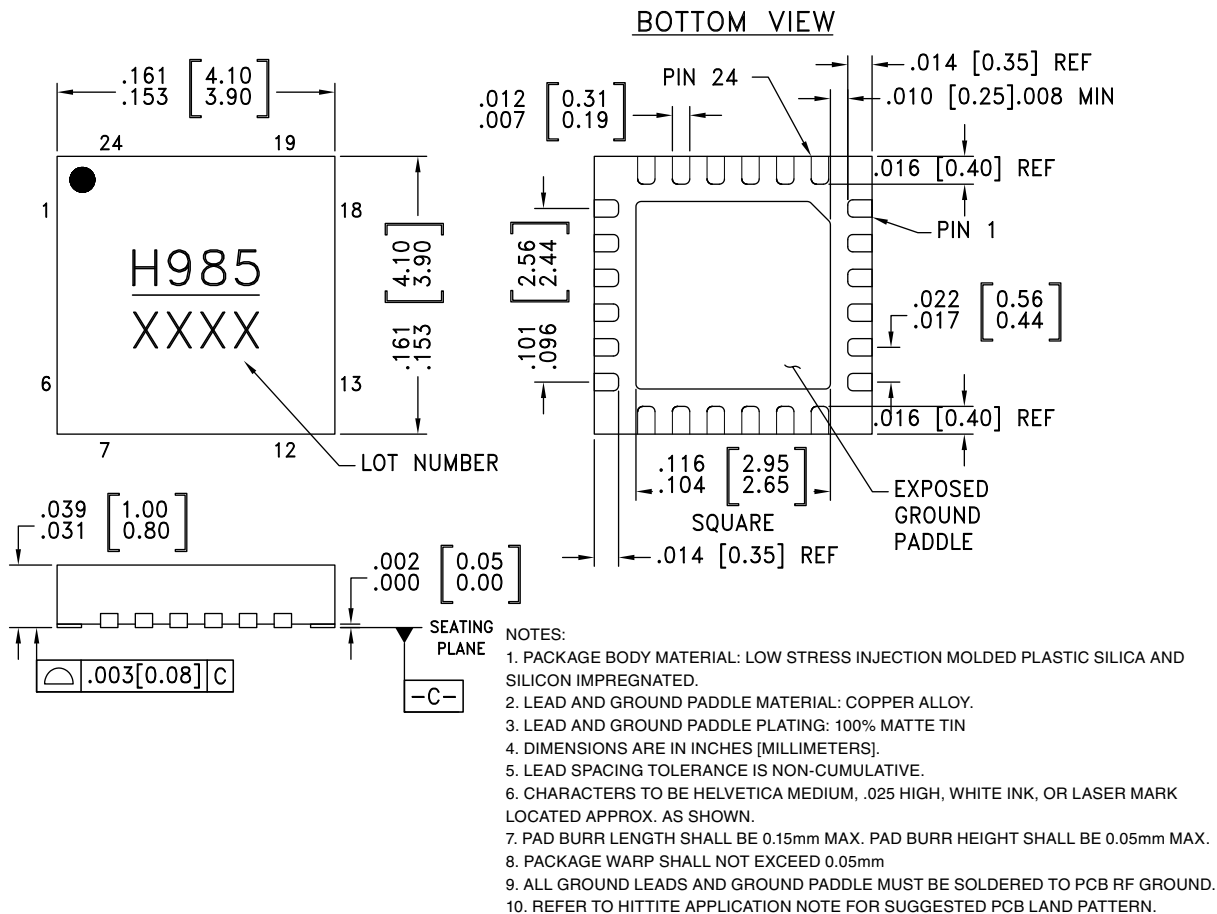

Package Information

| Part Number | Package Body Material | Lead Finish | MSL Rating | Package Marking |
|-------------|--|---------------|------------|-----------------|
| HMC985LP4KE | RoHS-compliant Low Stress Injection Molded Plastic | 100% matte Sn | MSL1 [1] | H985 XXX |

[1] Max peak reflow temperature of 260 °C

[2] 4-Digit lot number XXXX



GaAs MMIC VOLTAGE - VARIABLE ATTENUATOR, 10 - 40 GHz

Pin Descriptions

| Pin Number | Function | Description | Pin Schematic |
|-----------------------------|----------|---|---------------|
| 1, 2, 4-7, 12-15, 17-19, 24 | GND | These pins and package bottom must be connected to RF/DC ground externally. | |
| 3 | RFIN | This pad is DC coupled and matched to 50 Ohms. | |
| 8 | Vctl1 | Control Voltage 1. | |
| 9, 11, 20-23 | NC | These pins are not connected internally, however all data shown herein was measured with these pins connected to RF/DC ground externally. | |
| 10 | Vctl2 | Control Voltage 2. | |
| 16 | RFOUT | This pad is DC coupled and matched to 50 Ohms. | |

Application Circuit

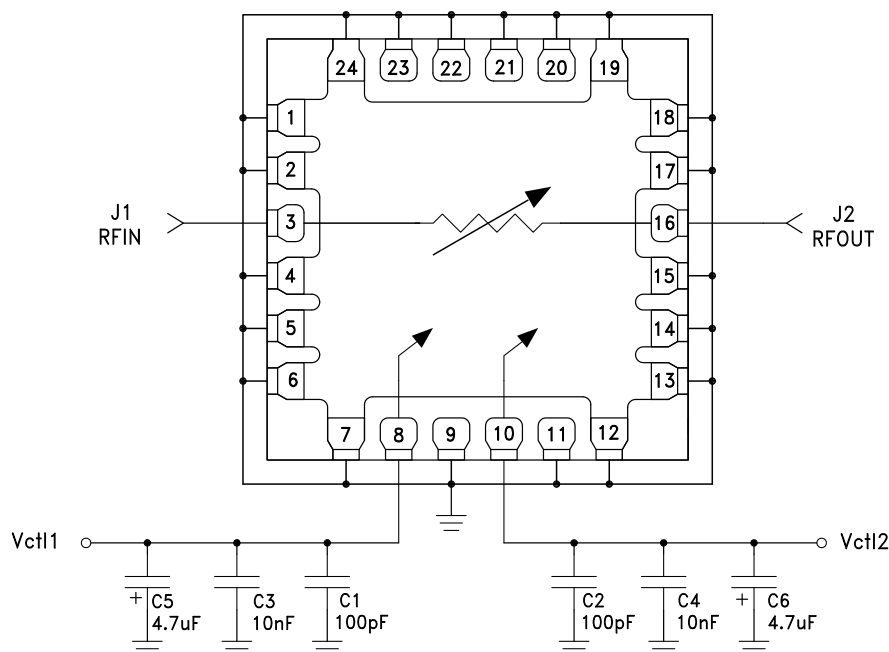

Information furnished by Analog Devices is believed to be accurate and reliable. However, no responsibility is assumed by Analog Devices for its use, nor for any infringements of patents or other rights of third parties that may result from its use. Specifications subject to change without notice. No license is granted by implication or otherwise under any patent or patent rights of Analog Devices. Trademarks and registered trademarks are the property of their respective owners.

For price, delivery, and to place orders: Analog Devices, Inc., One Technology Way, P.O. Box 9106, Norwood, MA 02062-9106 Phone: 781-329-4700 • Order online at www.analog.com Application Support: Phone: 1-800-ANALOG-D



**GaAs MMIC VOLTAGE - VARIABLE
ATTENUATOR, 10 - 40 GHz**

Evaluation PCB

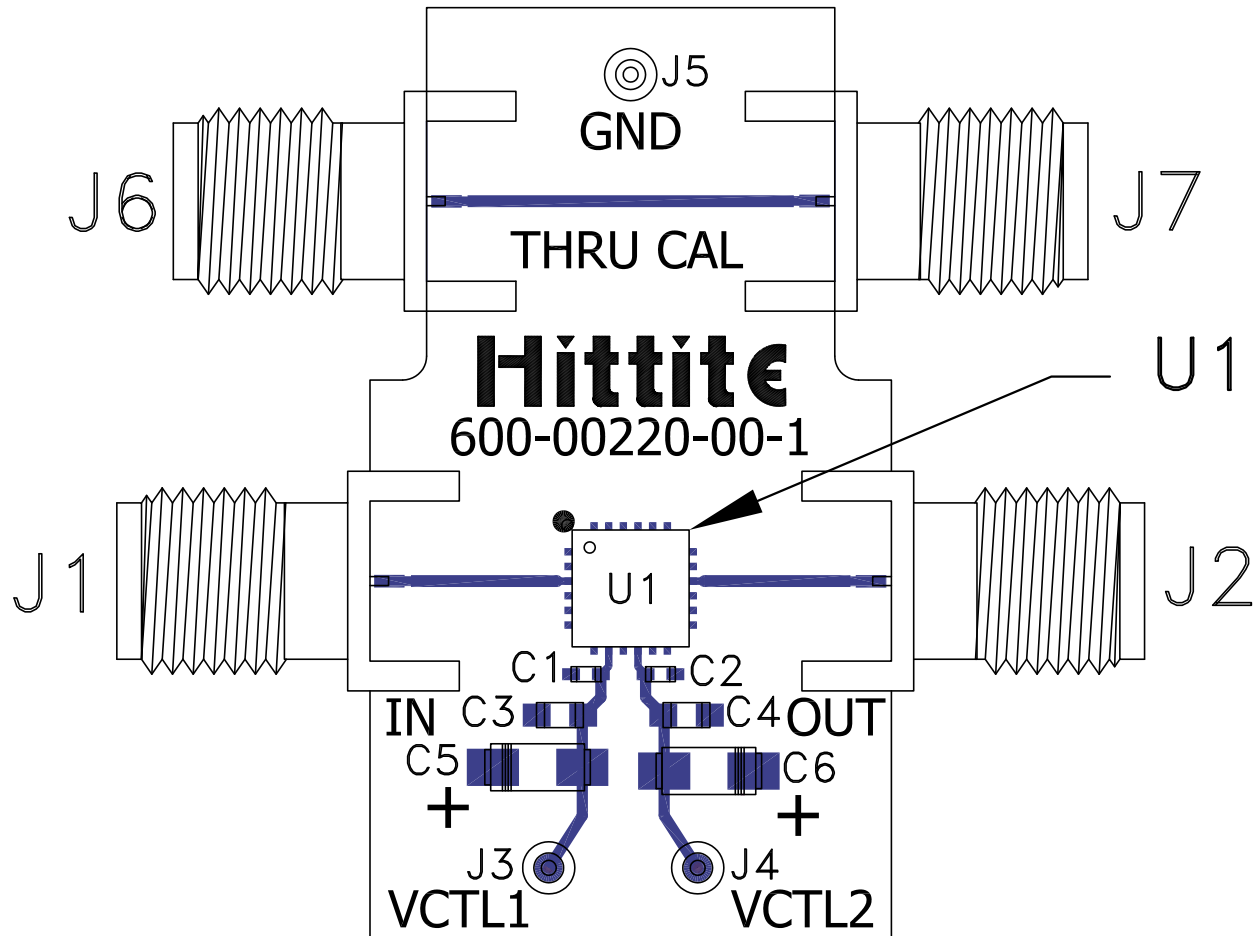

List of Materials for Evaluation PCB EVAL01-HMC985LP4KE [1]

| Item | Description |
|--------------|-----------------------------------|
| J1-J2, J6-J7 | K Connectors. |
| J3-J5 | DC Pins. |
| C1-C2 | 100pF Capacitors, 0402 Pkg. |
| C3-C4 | 0.01 μ F Capacitor, 0603 Pkg. |
| C5-C6 | 4.7 μ F Case A, Tantalum. |
| U1 | HMC985LP4KE VVA. |
| PCB | 600-00220-00 Evaluation PCB. |

[1] Reference this number when ordering complete evaluation PCB

The circuit board used in the final application should use RF circuit design techniques. Signal lines should have 50 Ohm impedance while the package ground leads and exposed paddle should be connected directly to the ground plane similar to that shown. A sufficient number of via holes should be used to connect the top and bottom ground planes. The evaluation circuit board shown is available from Hittite upon request.

**GaAs MMIC VOLTAGE - VARIABLE
ATTENUATOR, 10 - 40 GHz****Notes:**