



Chipsmall Limited consists of a professional team with an average of over 10 year of expertise in the distribution of electronic components. Based in Hongkong, we have already established firm and mutual-benefit business relationships with customers from,Europe,America and south Asia,supplying obsolete and hard-to-find components to meet their specific needs.

With the principle of “Quality Parts,Customers Priority,Honest Operation,and Considerate Service”,our business mainly focus on the distribution of electronic components. Line cards we deal with include Microchip,ALPS,ROHM,Xilinx,Pulse,ON,Everlight and Freescale. Main products comprise IC,Modules,Potentiometer,IC Socket,Relay,Connector.Our parts cover such applications as commercial,industrial, and automotives areas.

We are looking forward to setting up business relationship with you and hope to provide you with the best service and solution. Let us make a better world for our industry!



Contact us

Tel: +86-755-8981 8866 Fax: +86-755-8427 6832

Email & Skype: info@chipsmall.com Web: www.chipsmall.com

Address: A1208, Overseas Decoration Building, #122 Zhenhua RD., Futian, Shenzhen, China



GAAS MMIC REFLECTIVE SPDT SWITCH, 0.1 - 50 GHz

Typical Applications

The HMC986A is ideal for:

- Wideband Switching Matrices
- High Speed Data Infrastructure
- Military Comms, RADAR, and ECM
- Test and Measurement Equipment
- Jamming and EW Subsystems

Features

- Wideband Performance: 0.1 to 50 GHz
- Low Insertion Loss: 2.1 dB at 40 GHz
- High Isolation: 34 dB at 40 GHz
- Fast Switching Speed: 11 ns
- Compact Die Size: 0.98 x 0.75 x 0.1 mm

Functional Diagram

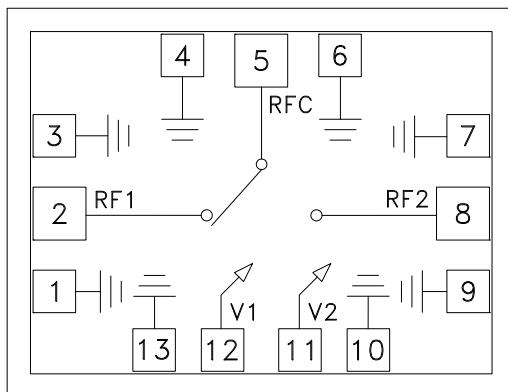

General Description

The HMC986A is a wideband GaAs pHEMT MMIC Single Pole Double Throw (SPDT) switch die. This tiny switch employs a reflective topology and is controlled with two complementary inputs of 0/-3V to 0/-5V. With an input signal at 40 GHz, the HMC986A exhibits 19 dB return loss, 34 dB isolation, and only 2.1 dB insertion loss. The combination of wideband performance and fast switching speed make this switch ideal for test equipment, switching matrices, and electronic warfare (EW) applications. RF performance is independent of high level control voltages, and is shown at both -3V and -5V for completeness.

Electrical Specifications, $T_A = +25^\circ\text{C}$, With 0/-3V to -5V Control, 50 Ohm System

Parameter	Frequency	Min.	Typ.	Max.	Units
Insertion Loss	0.1 - 18 GHz		2	2.3	dB
	18 - 40 GHz		2.1	2.5	dB
	40 - 50 GHz		2.3	2.8	dB
Isolation	0.1 - 18 GHz	30	36		dB
	18 - 40 GHz	25	34		dB
	40 - 50 GHz	22	30		dB
Return Loss	"On State"		19		dB
Input Power for 0.1 dB Compression	0.1 - 2 GHz		8		dBm
	2 - 50 GHz		25		dBm
Input Power for 1.0 dB Compression	0.1 - 2 GHz		12		dBm
	2 - 50 GHz	22	28		dBm
Input Third Order Intercept (Two-Tone Input Power = 0 dBm Each Tone, 1 MHz Tone Separation)	0.1 - 2 GHz		27		dBm
	2 - 50 GHz		40		dBm
Switching Characteristics tRISE, tFALL (10/90% RF)	0.1 - 50 GHz		2		ns
		tON, tOFF (50% CTL to 10/90% RF)	11		ns

HMC986A* PRODUCT PAGE QUICK LINKS

Last Content Update: 02/23/2017

COMPARABLE PARTS

View a parametric search of comparable parts.

DOCUMENTATION

Data Sheet

- HMC986A: GaAs MMIC Reflective SPDT Switch, 0.1 to 50 GHz Data Sheet

TOOLS AND SIMULATIONS

- HMC986A S-Parameters

DESIGN RESOURCES

- HMC986A Material Declaration
- PCN-PDN Information
- Quality And Reliability
- Symbols and Footprints

DISCUSSIONS

View all HMC986A EngineerZone Discussions.

SAMPLE AND BUY

Visit the product page to see pricing options.

TECHNICAL SUPPORT

Submit a technical question or find your regional support number.

DOCUMENT FEEDBACK

Submit feedback for this data sheet.

GAAS MMIC REFLECTIVE SPDT SWITCH, 0.1 - 50 GHz

Insertion Loss @-5V

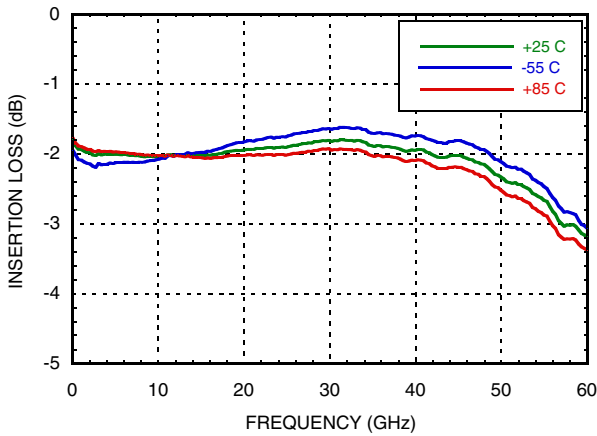

Insertion Loss @-3V

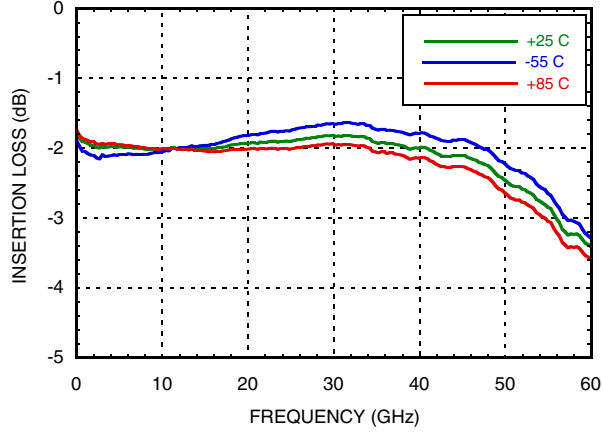

Isolation @-5V

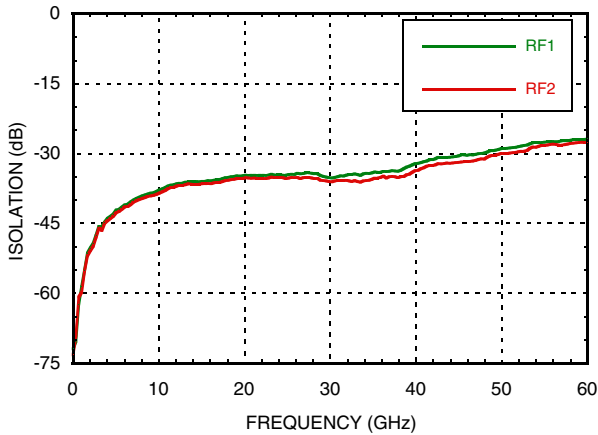

Isolation @-3V

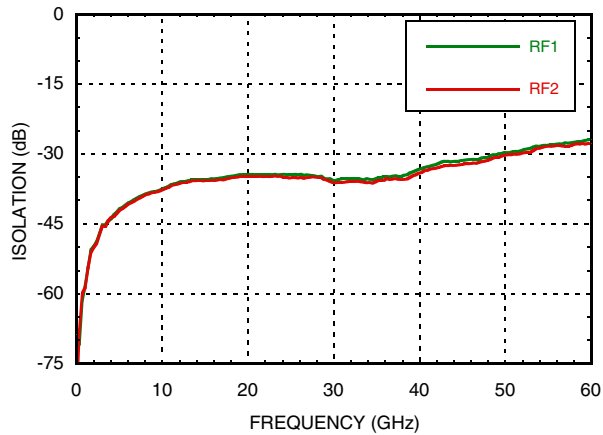

Return Loss @-5V

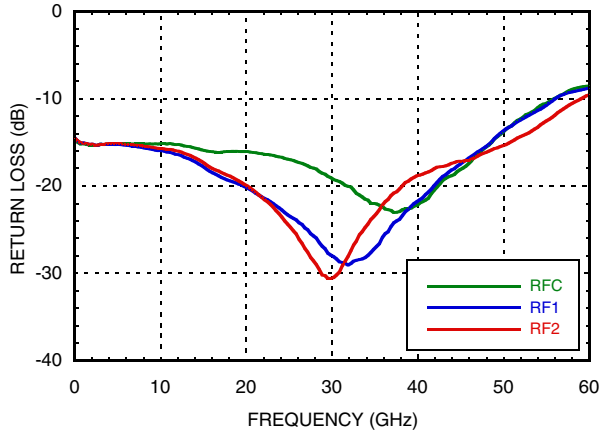

Return Loss @-3V

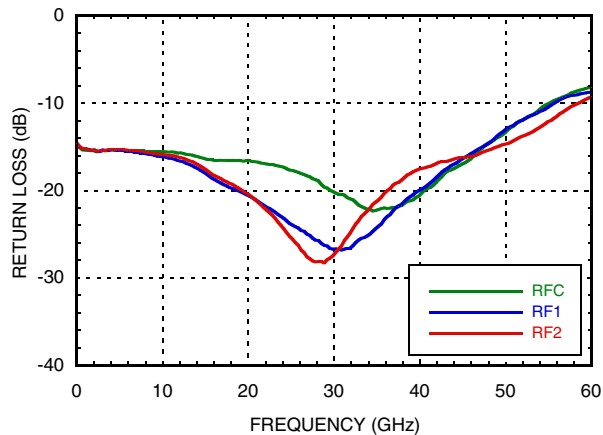

GAAS MMIC REFLECTIVE SPDT SWITCH, 0.1 - 50 GHz

SWITCHES - CHIP

Input Power for 0.1 dB Compression @ -5V [1]

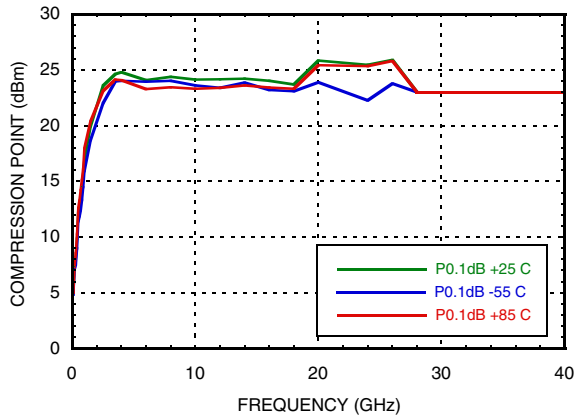

Input Power for 0.1 dB Compression @-3V [1]

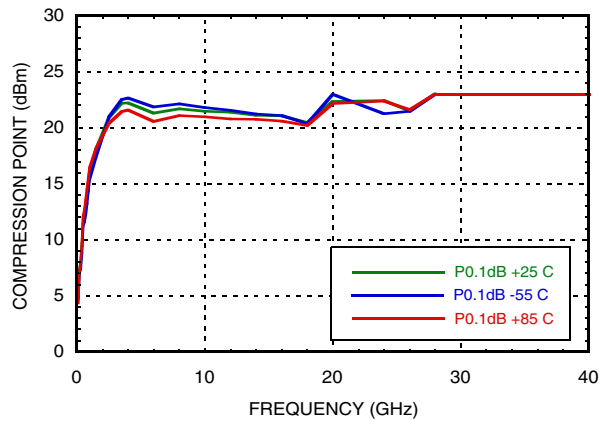

Input Power for 0.1 dB Compression @-5V (Low Frequency Detail) [1]

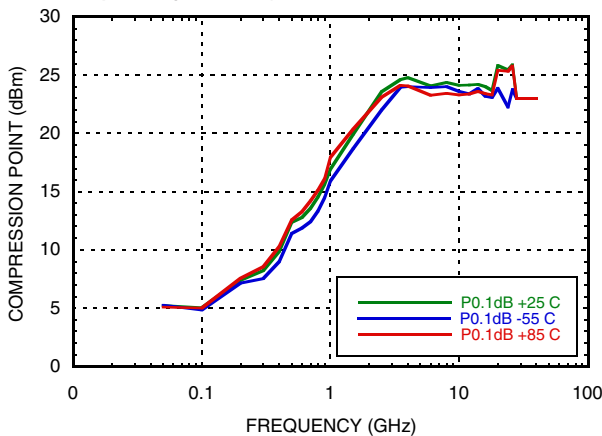

Input Power for 0.1 dB Compression @-3V (Low Frequency Detail) [1]

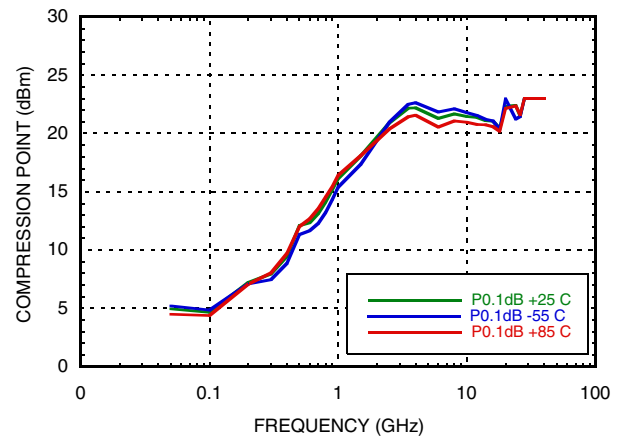

Input Power for 1.0 dB Compression @-5V (Low Frequency Detail) [1]

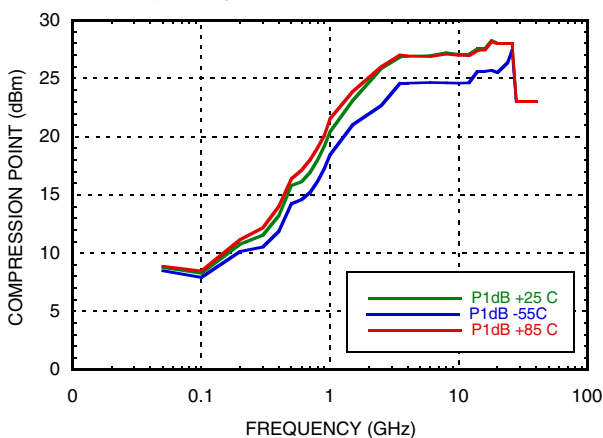

Input Power for 1.0 dB Compression @-3V (Low Frequency Detail) [1]

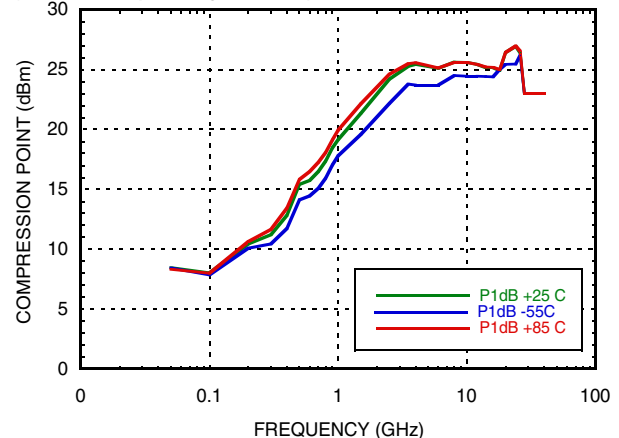

[1] Measurement conducted with max Pin=23dBm from 26GHz to 40 GHz.

GAAS MMIC REFLECTIVE SPDT SWITCH, 0.1 - 50 GHz

Input Third Order Intercept Point @-5V

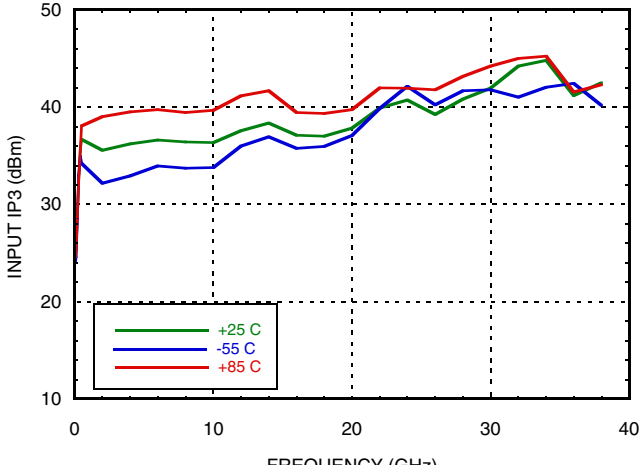

Input Third Order Intercept Point @-3V

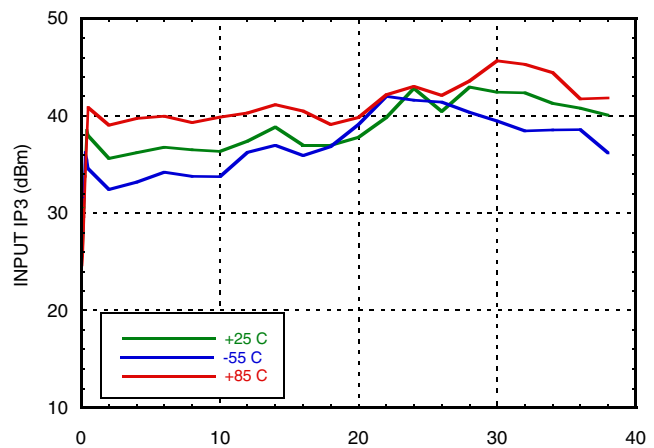

Input Third Order Intercept Point @-5V (Low Frequency Detail)

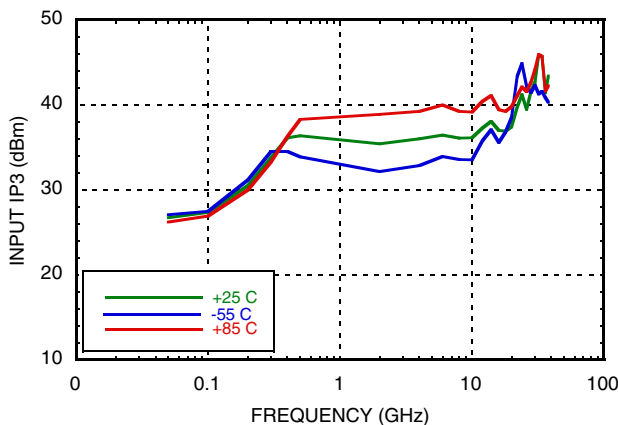

Input Third Order Intercept Point @-3V (Low Frequency Detail)

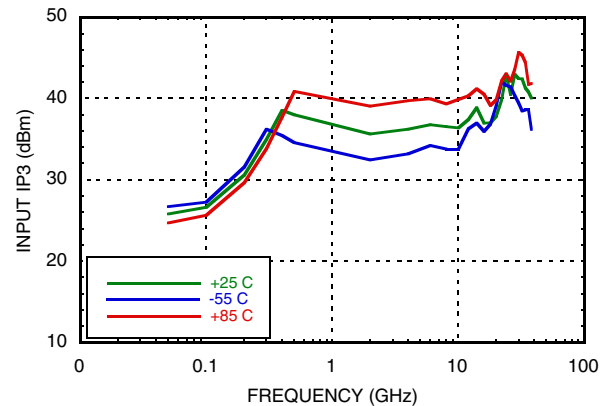

Absolute Maximum Ratings

Control Voltage Range (V1, V2)	+0.5 V to -5.5 V
RF Power Level	0.1 - 0.5 GHz +6 dBm 0.5 - 2 GHz +19 dBm 2- 50 GHz +27 dBm
Hot Switch Power Level	0.1 - 0.5 GHz +3 dBm 0.5 - 2 GHz +16 dBm 2- 50 GHz +24 dBm
Channel Temperature	150 °C
Continuous Pdiss (T=85°C) (derate 3.85 mW/°C above 85°C)	0.25 W
Thermal Resistance (channel to die bottom)	260 °C/W
Storage Temperature	-65 to +150 °C
Operating Temperature	-55 to +85 °C

Control Voltages

State	Bias Condition
Low	0 to -0.2V @ 1 uA Typ.
High	-3V to -5V @ 10 uA Typ.



**ELECTROSTATIC SENSITIVE DEVICE
OBSERVE HANDLING PRECAUTIONS**

Truth Table

V1	V2	State
High	Low	RFC to RF1
Low	High	RFC to RF2

GAAS MMIC REFLECTIVE SPDT SWITCH, 0.1 - 50 GHz

Outline Drawing

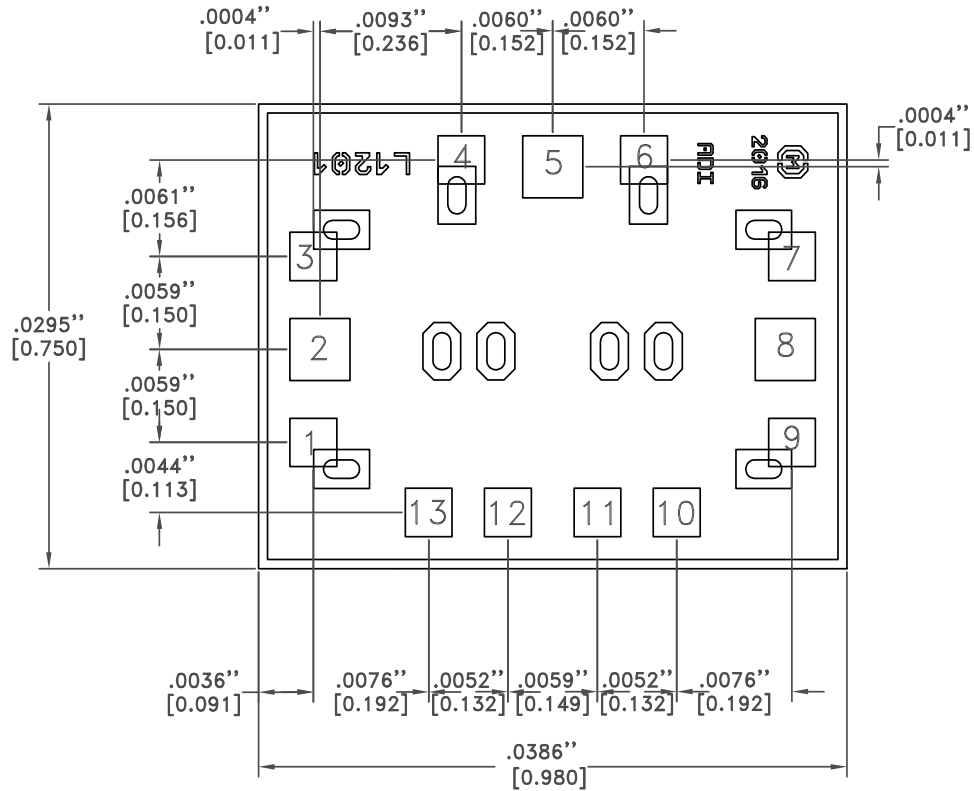

NOTES:

1. ALL DIMENSIONS ARE IN INCHES [MM]
2. DIE THICKNESS IS .004"
3. BACKSIDE METALIZATION: GOLD
4. BACKSIDE METAL IS GROUND
5. BOND PAD METALIZATION: GOLD
6. OVERALL DIE SIZE ±.002"

Die Packaging Information ^[1]

Standard	Alternate
WP-13 (Waffle Pack)	[2]

[1] Refer to the "Packaging Information" section of the ADI website for die packaging dimensions.



[2] For alternate packaging information contact Analog Devices Inc.

Die Pad Dimensions

Pad Number	Size
2, 5, 8	.004" x .004"
1, 3, 4, 6, 7, 9, 10, 11, 12, 13	.003" x .003"

GAAS MMIC REFLECTIVE SPDT SWITCH, 0.1 - 50 GHz

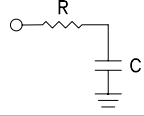
Pad Descriptions

Pad Number	Function	Description	Interface Schematic
2, 5, 8	RF1, RFC, RF2	These pads are DC coupled and matched to 50 Ohm. Blocking capacitors are required if RF line potential is not equal to 0V.	
11	V2	See truth table and control voltage table.	
12	V1		
1, 3, 4, 6, 7, 9	RF Signal Grounds	These pads are connected to die backside ground and can be utilized to realize Ground-Signal-Ground interface for optimum RF performance. HMC986A datasheet performance was measured with Ground-Signal-Ground interface on RF1, RFC, and RF2.	
10, 13	Control Signal Ground Returns	These pads are connected to die backside ground and are optional for use as V1, V2 control signal ground return.	

**GAAS MMIC REFLECTIVE
SPDT SWITCH, 0.1 - 50 GHz**

Assembly Diagram

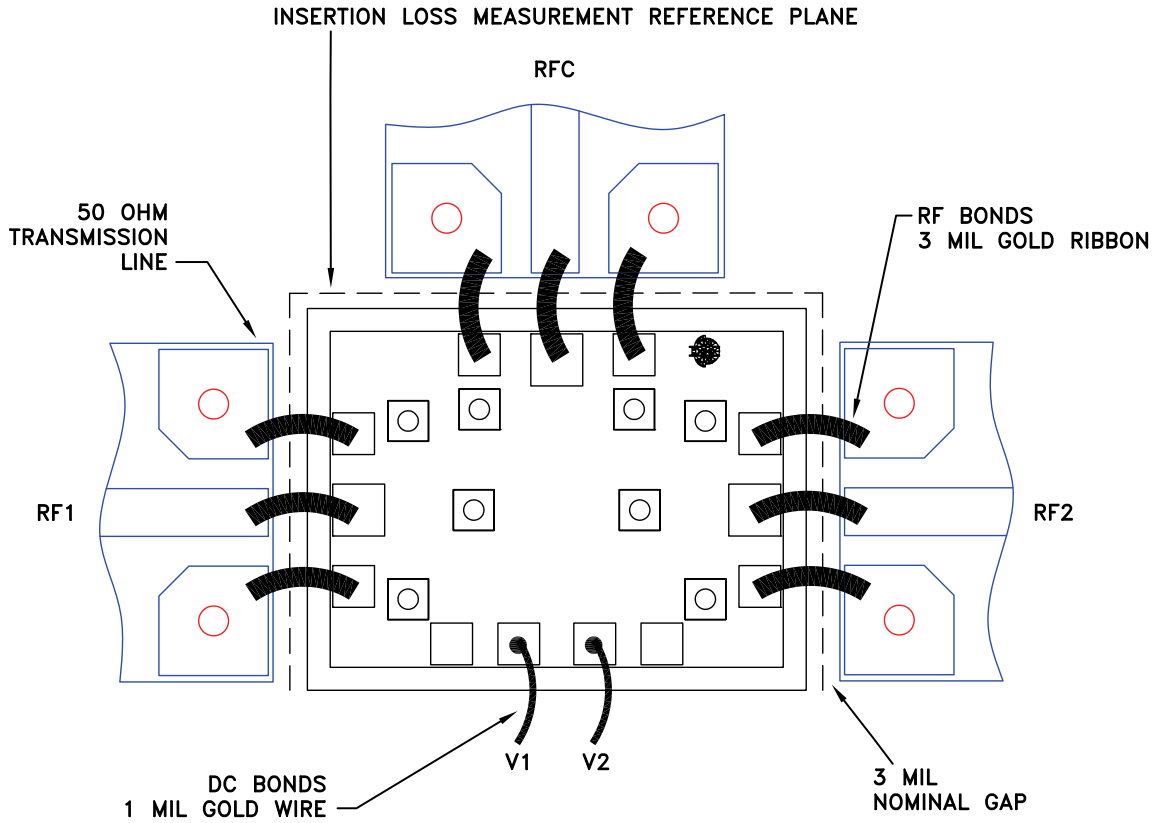

GAAS MMIC REFLECTIVE SPDT SWITCH, 0.1 - 50 GHz

Mounting & Bonding Techniques for Millimeterwave GaAs MMICs

The die should be attached directly to the ground plane eutectically or with conductive epoxy (see HMC general Handling, Mounting, Bonding Note).

50 Ohm Microstrip transmission lines on 0.127mm (5 mil) thick alumina thin film substrates are recommended for bringing RF to and from the chip (Figure 1). If 0.254mm (10 mil) thick alumina thin film substrates must be used, the die should be raised 0.150mm (6 mils) so that the surface of the die is coplanar with the surface of the substrate. One way to accomplish this is to attach the 0.102mm (4 mil) thick die to a 0.150mm (6 mil) thick molybdenum heat spreader (moly-tab) which is then attached to the ground plane (Figure 2).

Microstrip substrates should be brought as close to the die as possible in order to minimize bond wire length. Typical die-to-substrate spacing is 0.076mm (3 mils).

Handling Precautions

Follow these precautions to avoid permanent damage.

Storage: All bare die are placed in either Waffle or Gel based ESD protective containers, and then sealed in an ESD protective bag for shipment. Once the sealed ESD protective bag has been opened, all die should be stored in a dry nitrogen environment.

Cleanliness: Handle the chips in a clean environment. DO NOT attempt to clean the chip using liquid cleaning systems.

Static Sensitivity: Follow ESD precautions to protect against ESD strikes.

Transients: Suppress instrument and bias supply transients while bias is applied. Use shielded signal and bias cables to minimize inductive pick-up.

General Handling: Handle the chip along the edges with a vacuum collet or with a sharp pair of bent tweezers. The surface of the chip has fragile air bridges and should not be touched with vacuum collet, tweezers, or fingers.

Mounting

The chip is back-metallized and can be die mounted with AuSn eutectic preforms or with electrically conductive epoxy. The mounting surface should be clean and flat.

Epoxy Die Attach: Apply a minimum amount of epoxy to the mounting surface so that a thin epoxy fillet is observed around the perimeter of the chip once it is placed into position. Cure epoxy per the manufacturer's schedule.

Wire Bonding

Ball or wedge bond with 0.025 mm (1 mil) diameter pure gold wire (DC bias, IF1 and IF2) or Ribbon Bond (RF and LO ports) 0.076 mm x 0.013 mm (3 mil x 0.5 mil) size is recommended. Thermosonic wirebonding with a nominal stage temperature of 150 °C and a ball bonding force of 40 to 50 grams or wedge bonding force of 18 to 22 grams is recommended. Use the minimum level of ultrasonic energy to achieve reliable wirebonds. Wirebonds should be started on the chip and terminated on the package or substrate. All bonds should be as short as possible <0.31 mm (12 mils).

