



Chipsmall Limited consists of a professional team with an average of over 10 year of expertise in the distribution of electronic components. Based in Hongkong, we have already established firm and mutual-benefit business relationships with customers from,Europe,America and south Asia,supplying obsolete and hard-to-find components to meet their specific needs.

With the principle of “Quality Parts,Customers Priority,Honest Operation,and Considerate Service”,our business mainly focus on the distribution of electronic components. Line cards we deal with include Microchip,ALPS,ROHM,Xilinx,Pulse,ON,Everlight and Freescale. Main products comprise IC,Modules,Potentiometer,IC Socket,Relay,Connector.Our parts cover such applications as commercial,industrial, and automotives areas.

We are looking forward to setting up business relationship with you and hope to provide you with the best service and solution. Let us make a better world for our industry!



Contact us

Tel: +86-755-8981 8866 Fax: +86-755-8427 6832

Email & Skype: info@chipsmall.com Web: www.chipsmall.com

Address: A1208, Overseas Decoration Building, #122 Zhenhua RD., Futian, Shenzhen, China





GaAs pHEMT MMIC POWER AMPLIFIER, DC - 28 GHz

Typical Applications

The HMC994LP5E is ideal for:

- Test Instrumentation
- Microwave Radio & VSAT
- Telecom Infrastructure
- Military & Space
- Fiber optics

Features

- P1dB Output Power: +27 dBm
- Psat Output Power: +29 dBm
- High Gain: 13 dB
- Output IP3: +38 dBm
- Supply Voltage: Vdd = +10V @ 250 mA
- 50 Ohm Matched Input/Output
- 32 Lead 5x5 mm SMT Package: 25 mm²

Functional Diagram

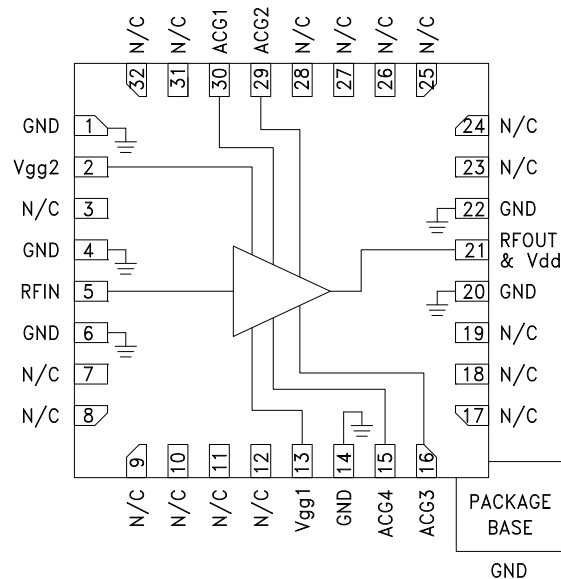

General Description

The HMC994LP5E is a GaAs pHEMT MMIC Distributed Wideband Power Amplifier which operates between DC and 28 GHz. The amplifier provides 13 dB of gain, +29 dBm of saturated output power, and 23% PAE from a +10V supply. With up to +38 dBm Output IP3 the HMC994LP5E is ideal for high linearity applications in military and space as well as point-to-point and point-to-multi-point radios. The HMC994LP5E exhibits a very flat gain from 4 to 16 GHz making it ideal for EW, ECM, Radar and test equipment applications. The HMC994LP5E amplifier I/Os are internally matched to 50 Ohms and is packaged in a leadless QFN 5x5 mm surface mount package.

Electrical Specifications, $T_A = +25^\circ C$, $V_{dd} = +10V$, $V_{gg2} = +3.5V$, $I_{dd} = 250 mA$ [1]

Parameter	Min.	Typ.	Max.	Min.	Typ.	Max.	Min.	Typ.	Max.	Units
Frequency Range				DC - 10			10 - 20			GHz
Gain	11	13		11	13		11	13		dB
Gain Flatness		±0.5			±0.5			±0.5		dB
Gain Variation Over Temperature		0.008			0.011			1.016		dB/°C
Input Return Loss		18			15			12		dB
Output Return Loss		18			16			12		dB
Output Power for 1 dB Compression (P1dB)	26	28		24.5	27		22.5	25		dBm
Saturated Output Power (Psat)		30			29.5			28		dBm
Output Third Order Intercept (IP3) [2]		41			37			35		dBm
Noise Figure		4			4			5		dB
Total Supply Current		250	300		250	300		250	300	mA

[1] Adjust Vgg1 between -2 to 0V to achieve Idd = 250 mA typical.

[2] Measurement taken at Pout / tone = +16 dBm.



**GaAs pHEMT MMIC
POWER AMPLIFIER, DC - 28 GHz**

Gain & Return Loss

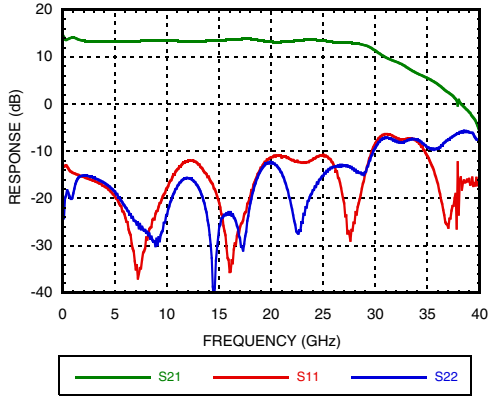

Gain vs. Temperature

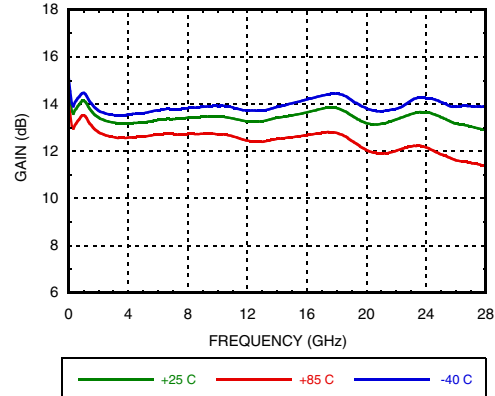

Input Return Loss vs. Temperature

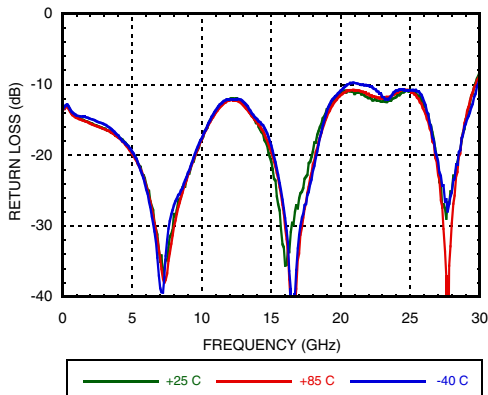

Output Return Loss vs. Temperature

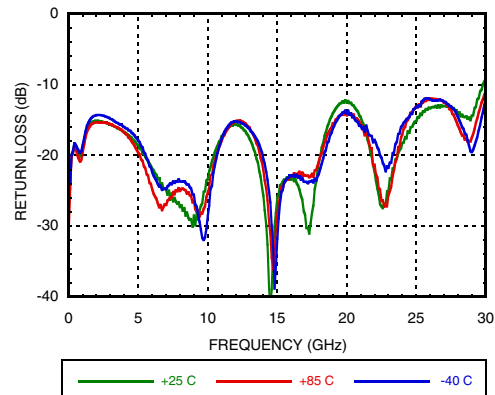

Noise Figure vs. Temperature

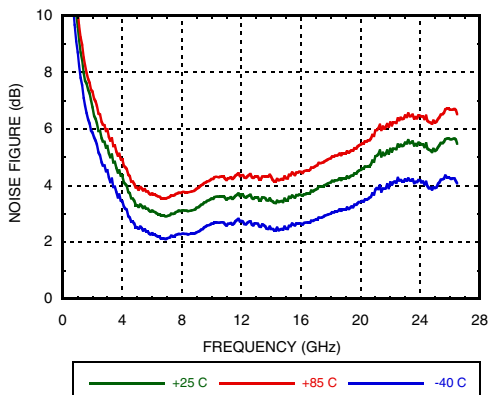

P1dB vs. Temperature

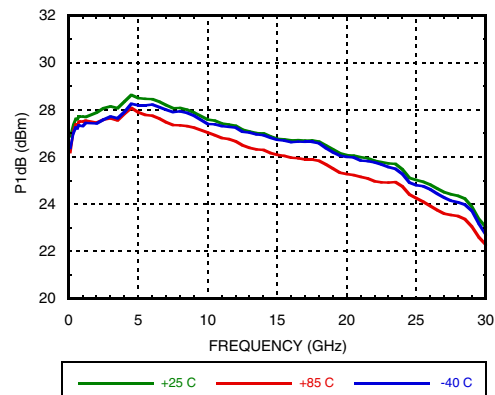

Information furnished by Analog Devices is believed to be accurate and reliable. However, no responsibility is assumed by Analog Devices for its use, nor for any infringements of patents or other rights of third parties that may result from its use. Specifications subject to change without notice. No license is granted by implication or otherwise under any patent or patent rights of Analog Devices. Trademarks and registered trademarks are the property of their respective owners.

For price, delivery, and to place orders: Analog Devices, Inc., One Technology Way, P.O. Box 9106, Norwood, MA 02062-9106 Phone: 781-329-4700 • Order online at www.analog.com Application Support: Phone: 1-800-ANALOG-D



**GaAs pHEMT MMIC
POWER AMPLIFIER, DC - 28 GHz**

P1dB vs. Supply Voltage

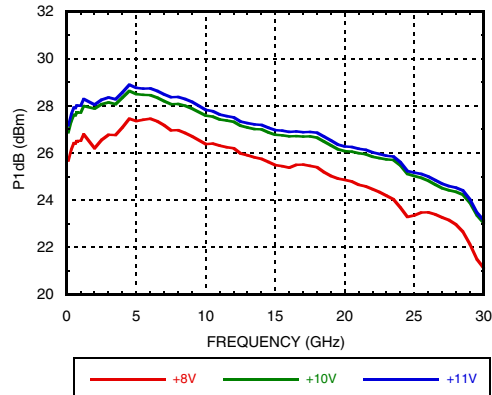

Psat vs. Temperature

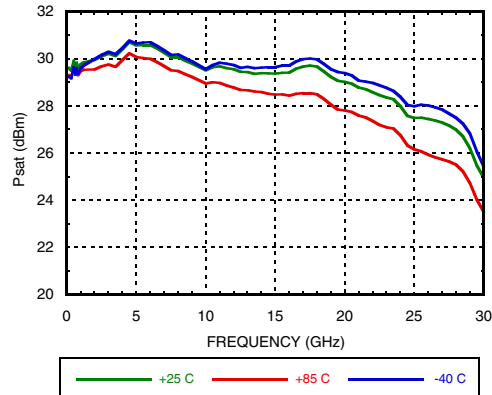

Psat vs. Supply Voltage

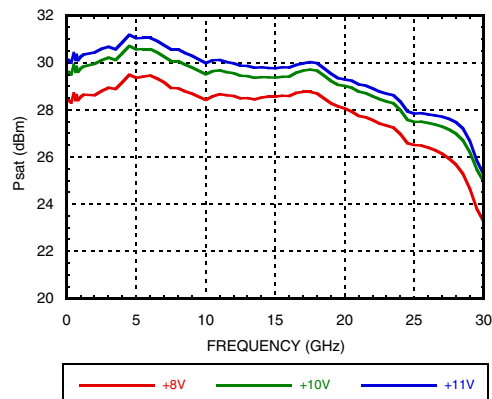

P1dB vs. Supply Current

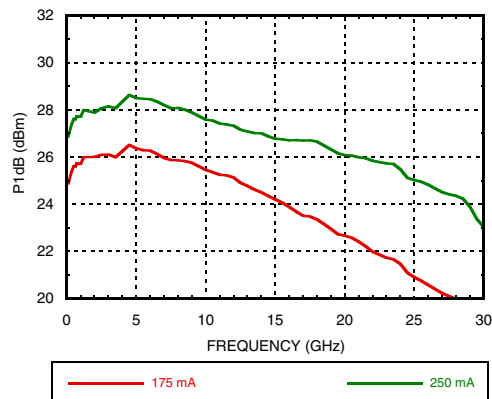

Psat vs. Supply Current

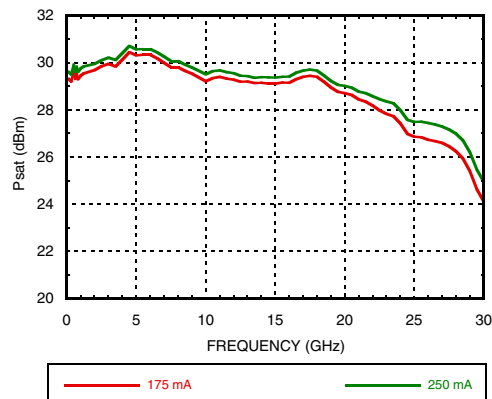

**Output IP3 vs. Temperature,
Pout/tone = +16 dBm**

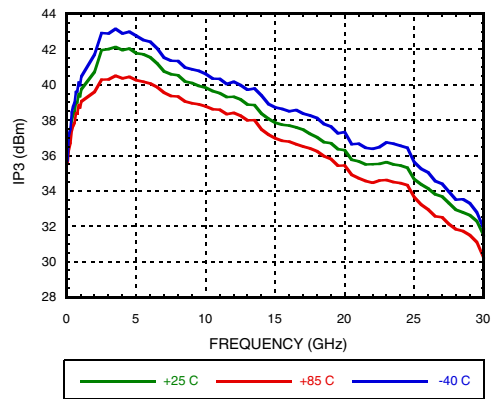

Information furnished by Analog Devices is believed to be accurate and reliable. However, no responsibility is assumed by Analog Devices for its use, nor for any infringements of patents or other rights of third parties that may result from its use. Specifications subject to change without notice. No license is granted by implication or otherwise under any patent or patent rights of Analog Devices. Trademarks and registered trademarks are the property of their respective owners.

For price, delivery, and to place orders: Analog Devices, Inc., One Technology Way, P.O. Box 9106, Norwood, MA 02062-9106
Phone: 781-329-4700 • Order online at www.analog.com
Application Support: Phone: 1-800-ANALOG-D



**GaAs pHEMT MMIC
POWER AMPLIFIER, DC - 28 GHz**

**Output IP3 vs. Supply Voltage,
Pout/tone = +16 dBm**

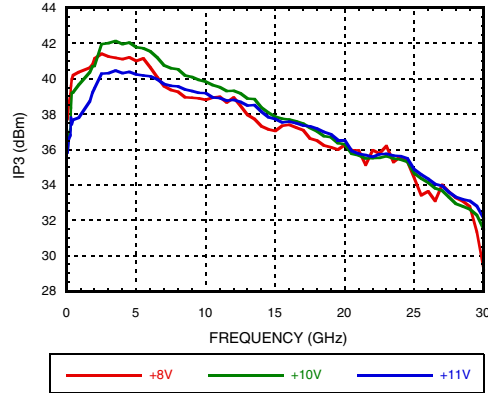

Output IM3 @ Vdd = +8V

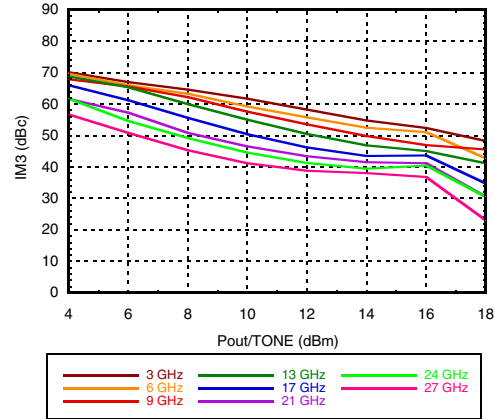

Output IM3 @ Vdd = +10V

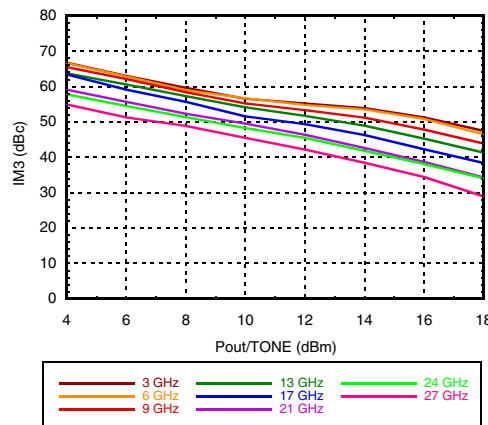

Output IM3 @ Vdd = +11V

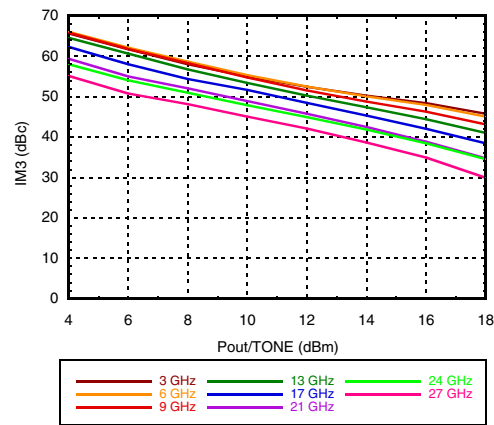

Reverse Isolation vs. Temperature

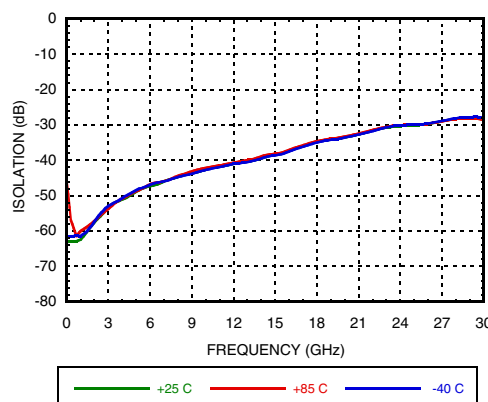

Power Compression @ 16 GHz

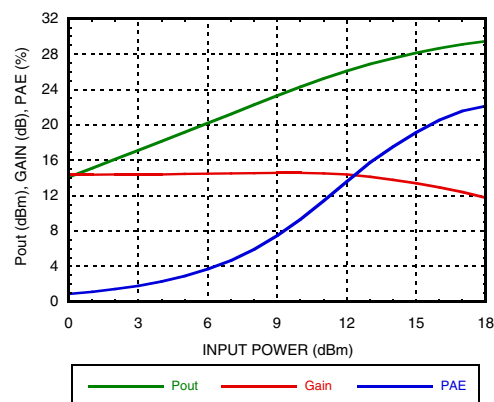

Information furnished by Analog Devices is believed to be accurate and reliable. However, no responsibility is assumed by Analog Devices for its use, nor for any infringements of patents or other rights of third parties that may result from its use. Specifications subject to change without notice. No license is granted by implication or otherwise under any patent or patent rights of Analog Devices. Trademarks and registered trademarks are the property of their respective owners.

For price, delivery, and to place orders: Analog Devices, Inc., One Technology Way, P.O. Box 9106, Norwood, MA 02062-9106 Phone: 781-329-4700 • Order online at www.analog.com Application Support: Phone: 1-800-ANALOG-D



**GaAs pHEMT MMIC
POWER AMPLIFIER, DC - 28 GHz**

**Gain & Power vs.
Supply Current @ 16 GHz**

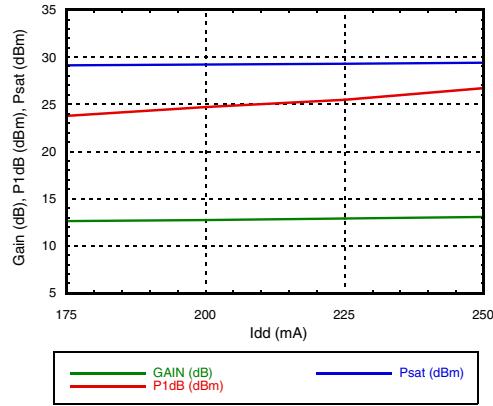

**Gain & Power vs.
Supply Voltage @ 16 GHz**

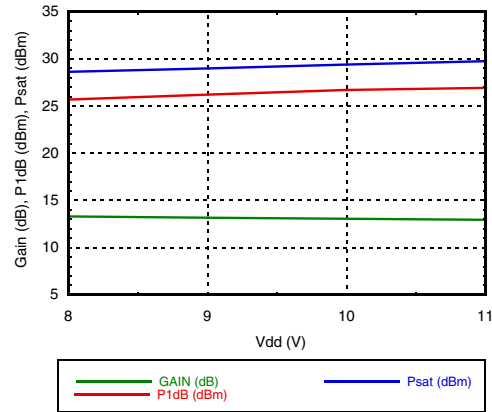

Power Dissipation

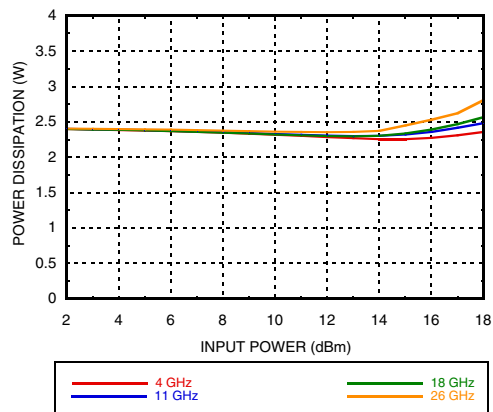

**Second Harmonics vs. Temperature @
Pout = 14 dBm**

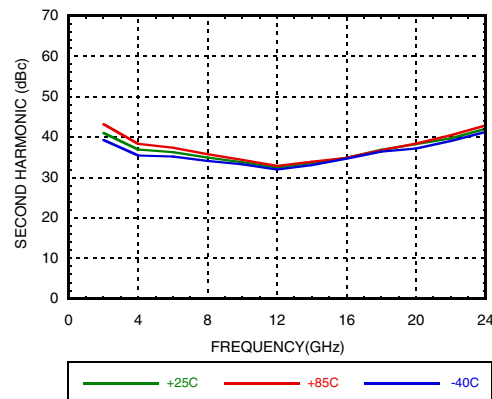

**Second Harmonics vs. Vdd @
Pout = 14 dBm**

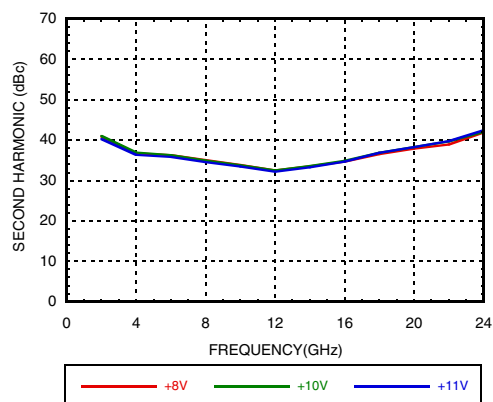

Second Harmonics vs. Pout

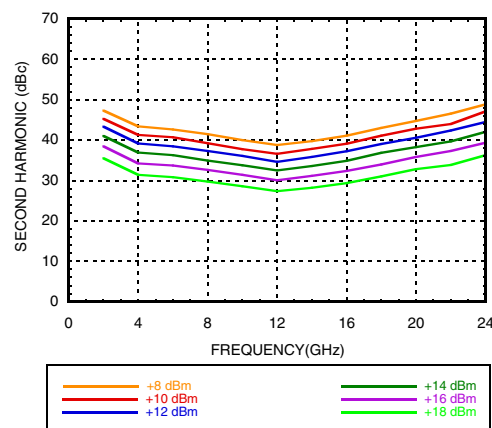

Information furnished by Analog Devices is believed to be accurate and reliable. However, no responsibility is assumed by Analog Devices for its use, nor for any infringements of patents or other rights of third parties that may result from its use. Specifications subject to change without notice. No license is granted by implication or otherwise under any patent or patent rights of Analog Devices. Trademarks and registered trademarks are the property of their respective owners.

For price, delivery, and to place orders: Analog Devices, Inc., One Technology Way, P.O. Box 9106, Norwood, MA 02062-9106 Phone: 781-329-4700 • Order online at www.analog.com Application Support: Phone: 1-800-ANALOG-D



GaAs pHEMT MMIC POWER AMPLIFIER, DC - 28 GHz

Absolute Maximum Ratings

Drain Bias Voltage (Vdd)	+12 Vdc
Gate Bias Voltage (Vgg1)	-3 to 0 Vdc
Gate Bias Voltage (Vgg2)	For Vdd = 12V, Vgg2 = 5.5V Idd < 200mA For Vdd between 8.5V to 11V, Vgg2 = (Vdd - 6.5V) up to 4.5V For Vdd < 8.5V, Vgg2 must remain > 2V
RF Input Power (RFIN)	+25 dBm
Channel Temperature	150 °C
Continuous Pdiss (T= 85 °C) (derate 46.1 mW/°C above 85 °C)	3.0 W
Thermal Resistance (channel to ground paddle)	21.6 °C/W
Storage Temperature	-65 to 150°C
Operating Temperature	-55 to 85 °C
ESD Sensitivity (HBM)	Class 1A

Typical Supply Current vs. Vdd

Vdd (V)	Idd (mA)
+8	250
+9	250
+10	250
+11	250

Adjust Vgg1 to achieve Idd = 250 mA



ELECTROSTATIC SENSITIVE DEVICE
OBSERVE HANDLING PRECAUTIONS

Outline Drawing

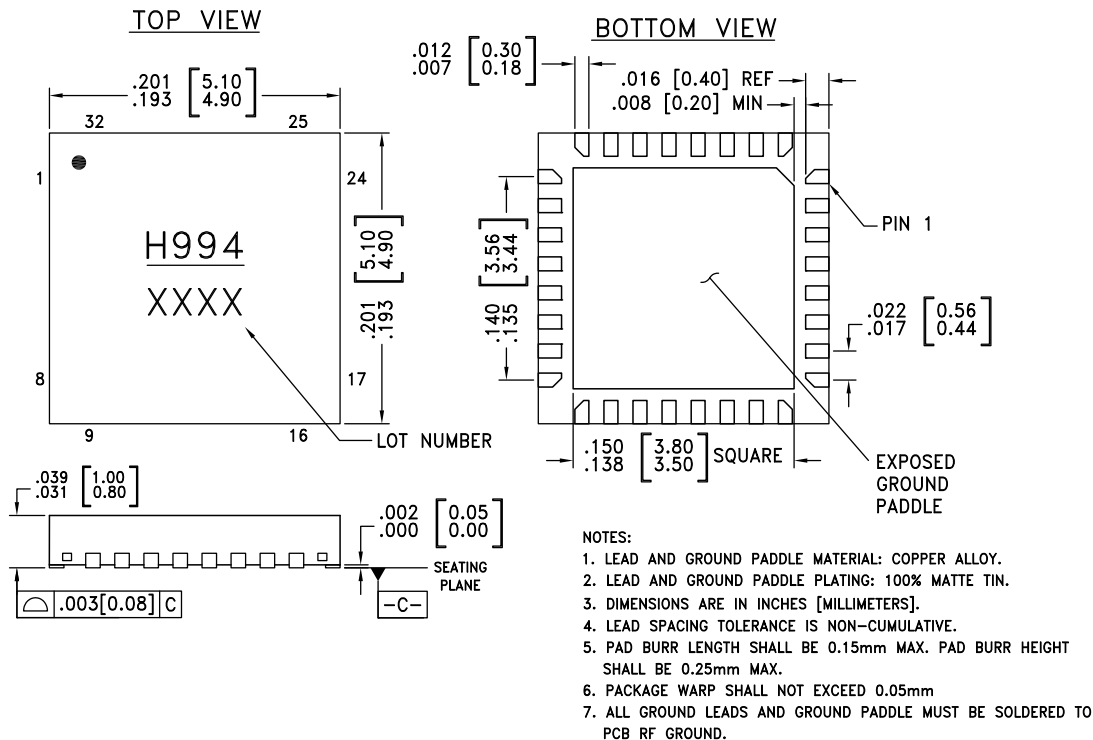

Package Information

Part Number	Package Body Material	Lead Finish	MSL Rating [2]	Package Marking [1]
HMC994LP5E	RoHS-compliant Low Stress Injection Molded Plastic	100% matte Sn	MSL1	H994 XXXX

[1] 4-Digit lot number XXXX

[2] Max peak reflow temperature of 260 °C



GaAs pHEMT MMIC POWER AMPLIFIER, DC - 28 GHz

Pin Descriptions

Pin Number	Function	Description	Interface Schematic
1, 4, 6, 14, 20, 22, Package Bottom	GND	These pins & exposed ground paddle must be connected to RF/DC ground.	
2	VGG2	Gate control 2 for amplifier. Attach bypass capacitor per application circuit herein. For nominal operation +3.5V should be applied to Vgg2	
3, 7, 8, 9, 10, 11, 12, 17, 18, 19, 23, 24, 25, 26, 27, 28, 31, 32	N/C	No connection required. These pins may be connected to RF/DC ground without affecting performance.	
5	RFIN	This pin is DC coupled and matched to 50 Ohms. Blocking capacitor is required.	
13	Vgg1	Gate control 1 for amplifier. Attach bypass capacitor per application circuit herein. Please follow "MMIC Amplifier Biasing Procedure" application note.	
15	ACG4	Low Frequency termination. Attach bypass capacitor per application circuit herein.	
16	ACG3		
21	RFOUT & Vdd	RF output for amplifier. Connect DC bias (Vdd) network to provide drain current (Idd). See application circuit herein.	
29	ACG2	Low frequency termination. Attach bypass capacitor per application circuit herein	
30	ACG1		



GaAs pHEMT MMIC POWER AMPLIFIER, DC - 28 GHz

Evaluation PCB

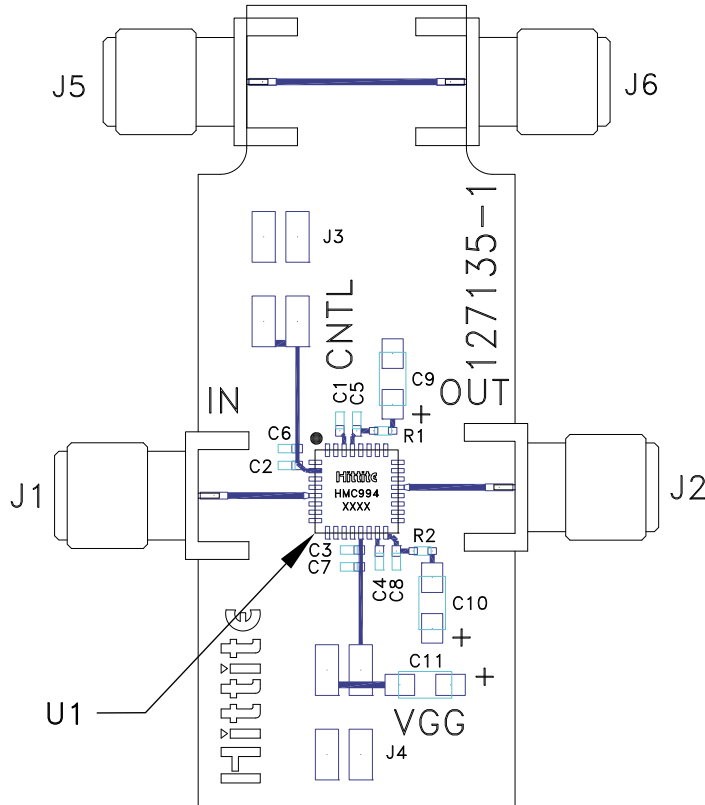

Evaluation Order Information

Item	Contents	Part Number
Evaluation PCB Only	HMC994LP5E Evaluation PCB	Eval01-HMC994LP5E [1]

[1] Reference this number when ordering Evaluation PCB Only

List of Materials for Evaluation PCB EVAL01-HMC994LP5E

Item	Description
J1, J2, J5, J6	PCB Mount SMA RF Connector
J3, J4	DC Pins.
C1 - C4	1000 pF Capacitor, 0402 Pkg.
C5 - C8	10 kpF Capacitor, 0402 Pkg.
C9 - C11	4.7 uF Capacitor, Tantalum.
R1, R2	0 Ohm Resistor, 0402 Pkg.
U1	HMC994LP5E
PCB [1]	127135 Evaluation PCB.

[1] Circuit Board Material: Rogers 4350 or Arlon 25FR

The circuit board used in the application should use RF circuit design techniques. Signal lines should have 50 Ohm impedance while the package ground leads and exposed paddle should be connected directly to the ground plane similar to that shown. A sufficient number of via holes should be used to connect the top and bottom ground planes. The evaluation circuit board shown is available from Hitrite upon request.



**GaAs pHEMT MMIC
POWER AMPLIFIER, DC - 28 GHz**

Application Circuit

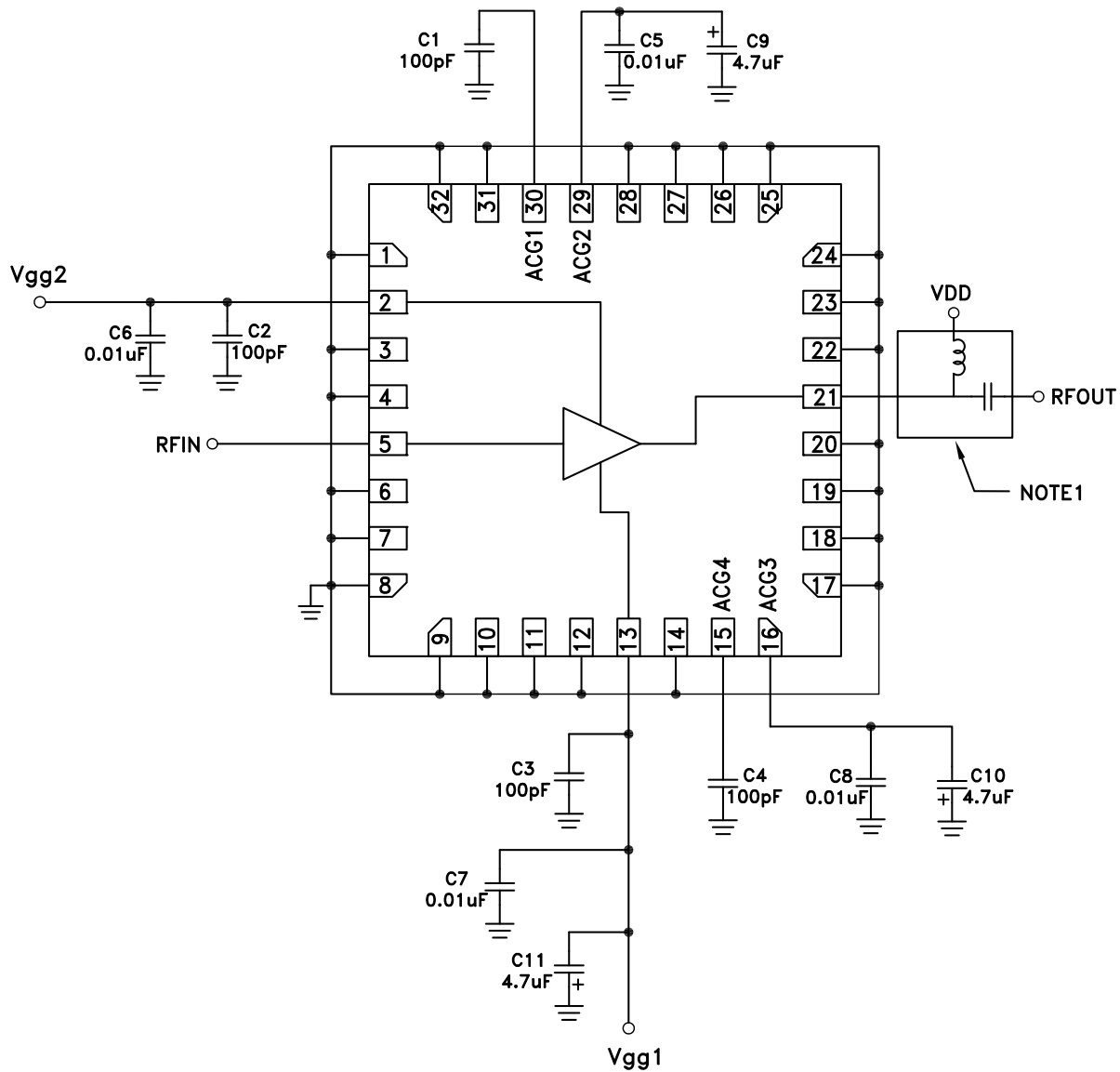

NOTE 1: Drain Bias (Vdd) must be applied through a broadband bias tee or external bias network.

Information furnished by Analog Devices is believed to be accurate and reliable. However, no responsibility is assumed by Analog Devices for its use, nor for any infringements of patents or other rights of third parties that may result from its use. Specifications subject to change without notice. No license is granted by implication or otherwise under any patent or patent rights of Analog Devices. Trademarks and registered trademarks are the property of their respective owners.

For price, delivery, and to place orders: Analog Devices, Inc., One Technology Way, P.O. Box 9106, Norwood, MA 02062-9106 Phone: 781-329-4700 • Order online at www.analog.com Application Support: Phone: 1-800-ANALOG-D

**GaAs pHEMT MMIC
POWER AMPLIFIER, DC - 28 GHz****Notes**