



Chipsmall Limited consists of a professional team with an average of over 10 year of expertise in the distribution of electronic components. Based in Hongkong, we have already established firm and mutual-benefit business relationships with customers from,Europe,America and south Asia,supplying obsolete and hard-to-find components to meet their specific needs.

With the principle of "Quality Parts,Customers Priority,Honest Operation,and Considerate Service",our business mainly focus on the distribution of electronic components. Line cards we deal with include Microchip,ALPS,ROHM,Xilinx,Pulse,ON,Everlight and Freescale. Main products comprise IC,Modules,Potentiometer,IC Socket,Relay,Connector.Our parts cover such applications as commercial,industrial, and automotives areas.

We are looking forward to setting up business relationship with you and hope to provide you with the best service and solution. Let us make a better world for our industry!



Contact us

Tel: +86-755-8981 8866 Fax: +86-755-8427 6832

Email & Skype: info@chipsmall.com Web: www.chipsmall.com

Address: A1208, Overseas Decoration Building, #122 Zhenhua RD., Futian, Shenzhen, China



The BWA series are converter adapters used for connecting connectors of different series.

- (1) Has mating portions compatible in materials and finish with the respective series.
- (2) Conforms in performance to the lower series of the two connectors to be connected.

Converter adapter list

Mating portion 1		Mating portion 2		Part No.	CL No.	Remarks	Shape
Series name	Mating portion	Series name	Mating portion				
N	P	BNC	P	NP-BNCP	311-0050-7		Fig.1
			J	JUG-201A/U	311-0007-8		Fig.2
		M	J	NP-MJ	311-0019-7		Fig.3
			J	N.P-S.J	311-0245-6		Fig.4
		HRM	P	HRM-555S	311-0125-4		Fig.5
			J	HRM-554S	311-0123-9		Fig.6
	J	BNC	P	UG-349/U	311-0004-0		Fig.7
				J	NJ-BNCJ	311-0005-2	
			J	NJ-BNCJ-PA	311-0014-3	Panel-mount type	Fig.9
		M	P	NJ-MP	311-0018-4		Fig.10
			J	NJ-MJ	311-0011-5		Fig.11
		TNC	P	N.J-TNC.P	311-0225-9		Fig.12
		HRM	P	HRM-553S	311-0121-3		Fig.13
				HRM-557S	311-0138-6	Panel-mount type	Fig.14
			J	HRM-552S	311-0119-1		Fig.15
				HRM-556S	311-0127-0	Panel-mount type	Fig.16
BNC	P	M	P	BNCP-MP	311-0062-6		Fig.17
			J	BNCP-MJ	311-0008-0		Fig.18
		S	P	SP-BNCP	311-0055-0		Fig.19
			J	SJ-BNCP	311-0060-0		Fig.20
		UM	J	BNCP-UMJ	311-0065-4		Fig.21
		MSS	P	BNCP-MSSP	311-0107-2		Fig.22
	J		BNCP-MSSJ	311-0082-3		Fig.23	
	HRM	P	HRM-519(09)	311-0101-6-09		Fig.24	
		J	HRM-518(09)	311-0100-3-09		Fig.25	
	J	UHF	P	UG-273/U	311-0003-7		Fig.26
		M	P	BNCJ-MP	311-0009-3		Fig.27
			J	MJ-BNCJ	311-0020-6		Fig.28
		S	P	SP-BNCJ	311-0058-9		Fig.29
				J	SJ-BNCJ	311-0054-8	
J			SJ-BNCJ-PA	311-0108-5	Panel-mount type	Fig.31	
TNC		J	BNC.J-TNC.J	311-0194-7		Fig.32	
UM		P	BNCJ-UMP	311-0052-2		Fig.33	
	J	BNCJ-UMJ	311-0053-5		Fig.34		
MSS	P	BNCJ-UMJ-PA(04)	311-0103-1-04	Panel-mount type	Fig.35		
		BNCJ-MSSP	311-0081-0		Fig.36		
J	BNCJ-MSSJ	311-0066-7		Fig.37			

BWA SERIES RF CO-AXIAL CONNECTORS

Mating portion 1		Mating portion 2		Part No.	CL No.	Remarks	Shape		
Series name	Mating portion	Series name	Mating portion						
BNC	J	HRM	P	HRM-517(09)	311-0099-6-09		Fig.38		
			J	HRM-516(09)	311-0102-9-09		Fig.39		
		POD	P	BNCJ-PODP	311-0160-5		Fig.40		
			J	BNCJ-PODJ	311-0161-8		Fig.41		
		PO6	J	BNCJ-PO6J	311-0167-4		Fig.42		
S	P	HRM	P	HRM-509(09)	311-0093-0-09		Fig.43		
			J	HRM-508(09)	311-0092-7-09		Fig.44		
	J	HRM	P	HRM-507(09)	311-0091-4-09		Fig.45		
				HRM-512(09)	311-0098-3-09	Panel-mount type	Fig.46		
			HRM-512S	311-0144-9	Panel-mount type, S type	Fig.46			
			HRM-506(09)	311-0090-1-09		Fig.47			
			J	HRM-511(09)	311-0094-2-09	Panel-mount type	Fig.48		
			HRM-511S	311-0143-6	Panel-mount type, S type	Fig.48			
TNC	J	HRM	J	HRMJ-TNCJ-PA	311-0202-3	Panel-mount type	Fig.49		
UM	P	HRM	J	UM.P-HRM.J	311-0176-5		Fig.50		
	J	HRM	J	HRMJ-UMJ	311-0164-6		Fig.51		
HRM	P	POB	P	HRMP-POBP-1	311-0169-0		Fig.52		
			J	HRMP-POBJ	311-0152-7		Fig.53		
		POD	J	HRM.P-POD.J	311-0177-8		Fig.54		
		POD1	J	HRMP-POD1J	311-0253-4		Fig.55		
		PO6	J	HRMP-PO6J	311-0172-4		Fig.56		
		S.FLSFL2	J	HRMP-S.FLJ-2	311-0249-7	For inspecting harnessed parts	Fig.57		
		H.FL	J	HRMP-H.FLJ	311-0232-4	For inspecting harnessed parts	Fig.58		
		HRMM	P	HRMP-HRMMP	311-0250-6		Fig.59		
			J	HRMP-HRMMJ	311-0243-0		Fig.60		
					J	HRMP-HRMMJ-LA	311-0226-1		Fig.61
		J	POB	P	HRMJ-POBP	311-0151-4		Fig.62	
	HRMJ-POBP-PA				311-0206-4		Fig.63		
	J			HRMJ-POBJ	311-0149-2		Fig.64		
				HRMJ-POBJ-PA	311-0150-1		Fig.65		
	POD		P	HRMJ-PODP	311-0157-0		Fig.66		
	POD1		P	HRMJ-POD1P-1	311-0254-7		Fig.67		
	PO6		P	HRMJ-PO6P	311-0173-7		Fig.68		
	PO51		P	HRMJ-PO51P	311-0231-1		Fig.69		
	FL		P	HRMJ-FLP-1	311-0195-0		Fig.70		
			J	HRMJ-FLJ	311-0179-3		Fig.71		
	S.FLSFL2		P	HRMJ-S.FLP	311-0218-3		Fig.72		
	H.FL		P	HRMJ-H.FLP-3	311-0264-0		Fig.73		
	HRMM	P	HRMJ-HRMMP-2	311-0221-8		Fig.74			
HRMJ-HRMMP-LA			311-0227-4		Fig.75				
J		HRMJ-HRMMJ	311-0220-5		Fig.76				

Note 1. Part No. NP-BNCP of Fig.1 is shown that series name N, coupling part p (plug) for connecting part 1 and series name BNC, coupling part P (plug) for connecting part 2.

2. Series name of each connecting parts are shown in order to HIROSE's CL numbers.

Fig.1

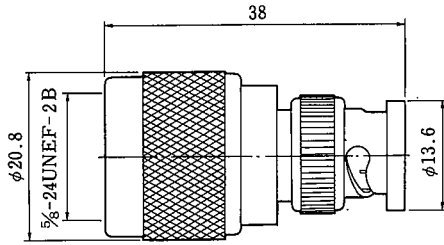

NP-BNCP
CL311-0050-7

Fig.2

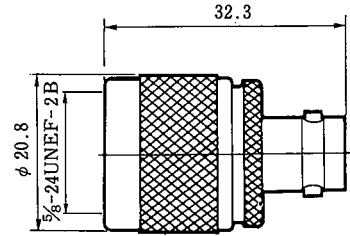

UG-201A/U
CL311-0007-8

Fig.3

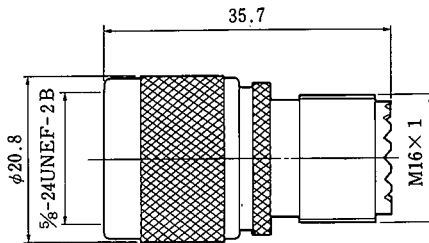

NP-MJ
CL311-0019-7

Fig.4

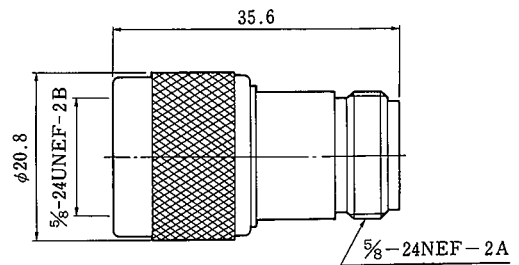

N.P-S.J
CL311-0245-6

Fig.5

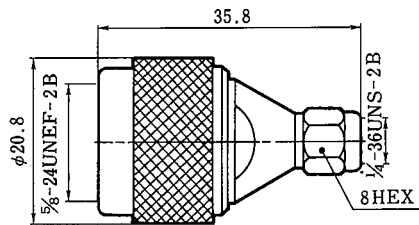

HRM-555S
CL311-0125-4

Fig.6

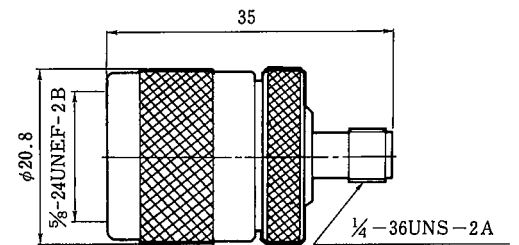

HRM-554S
CL311-0123-9

Fig.7

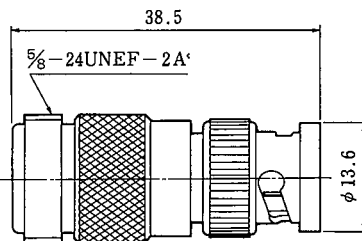

UG-349/U
CL311-0004-0

Fig.8

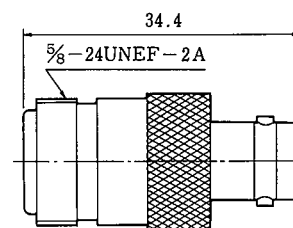

NJ-BNCJ
CL311-0005-2

Fig.9

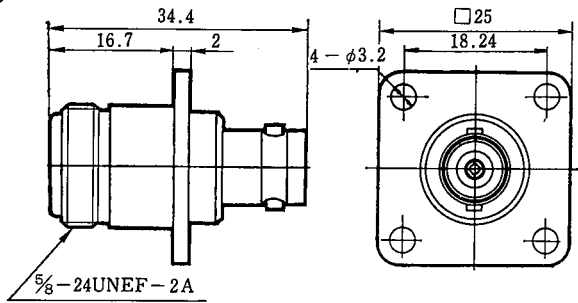

NJ-BNCJ-PA
CL311-0014-3

Fig.10

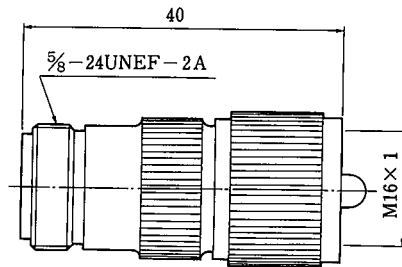

NJ-MP
CL311-0018-4

Fig.11

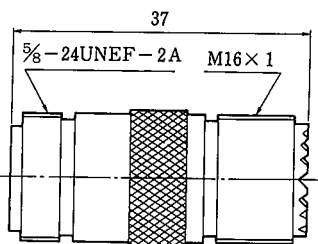

NJ-MJ
CL311-0011-5

Fig.12

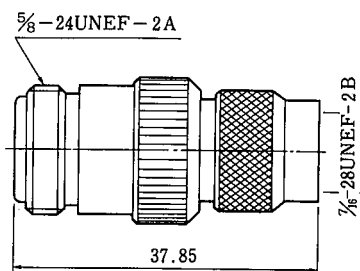

N.J-TNC.P
CL311-0225-9

Fig.13

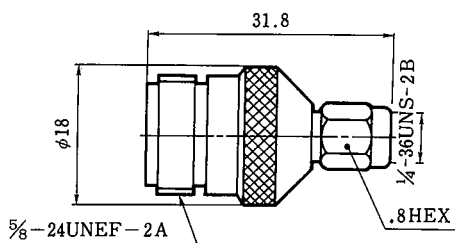

HRM-553S
CL311-0121-3

Fig.14

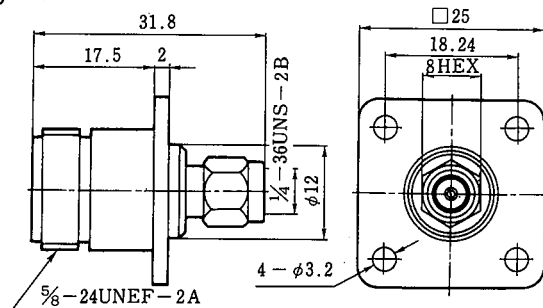

HRM-557S
CL311-0138-6

Fig.15

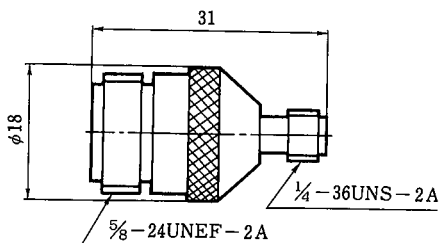

HRM-552S
CL311-0119-1

Fig.16

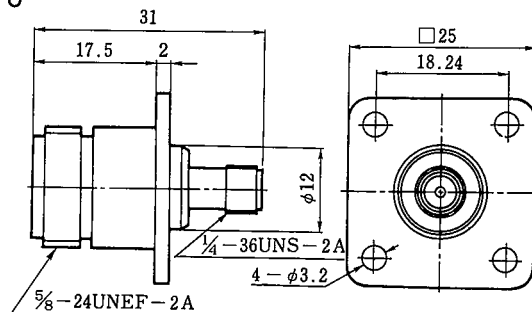

HRM-556S
CL311-0127-0

Fig.17

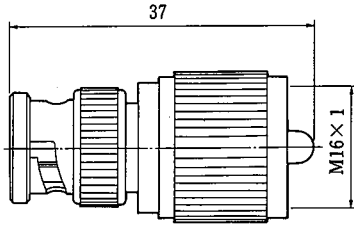

BNCP-MP
CL311-0062-6

Fig.18

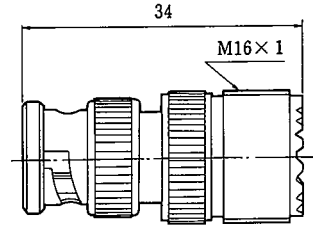

BNCP-MJ
CL311-0008-0

Fig.19

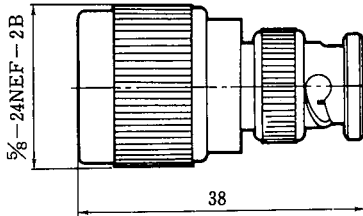

SP-BNCP
CL311-0055-0

Fig.20

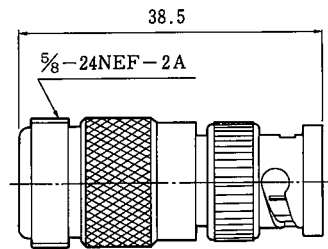

SJ-BNCP
CL311-0060-0

Fig.21

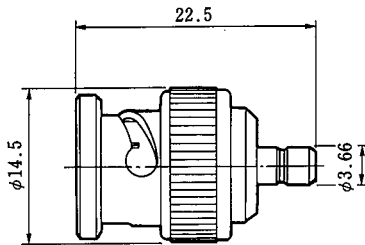

BNCP-UMJ
CL311-0065-4

Fig.22

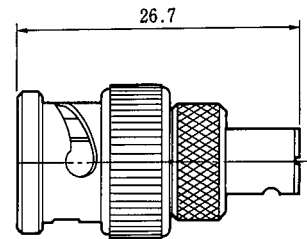

BNCP-MSSP
CL311-0107-2

Fig.23

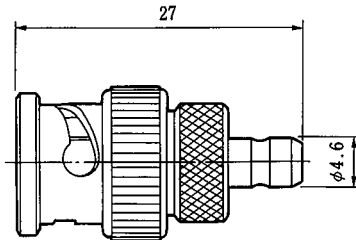

BNCP-MSSJ
CL311-0082-3

Fig.24

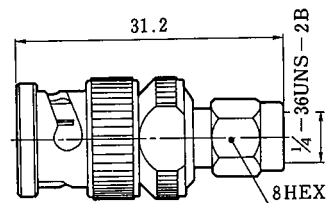

HRM-519(09)
CL311-0101-6-09

BWA SERIES RF CO-AXIAL CONNECTORS

Fig.25

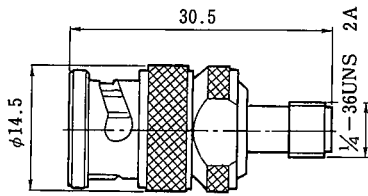

HRM-518(09)
CL311-0100-3-09

Fig.26

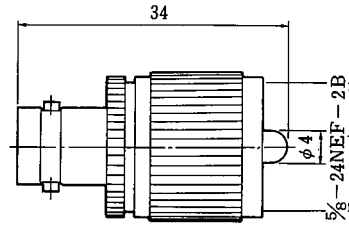

UG-273/U
CL311-0003-7

Fig.27

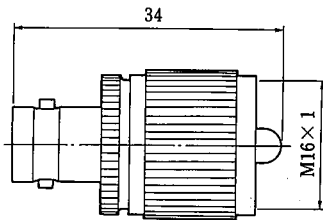

BNCJ-MP
CL311-0009-3

Fig.28

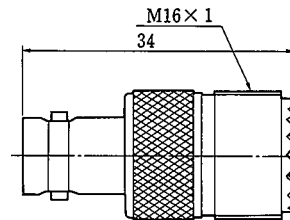

MJ-BNCJ
CL311-0020-6

Fig.29

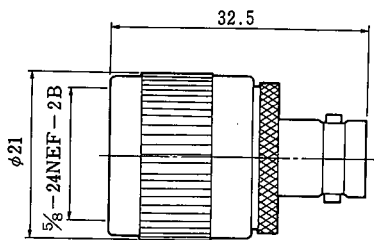

SP-BNCJ
CL311-0058-9

Fig.30

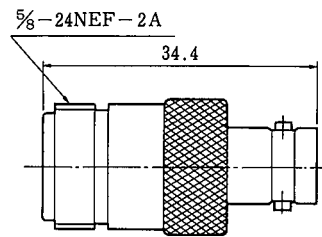

SJ-BNCJ
CL311-0054-8

Fig.31

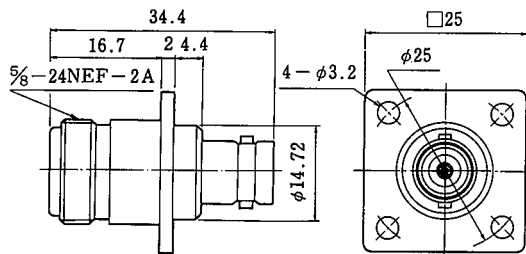

SJ-BNCJ-PA
CL311-0108-5

Fig.32

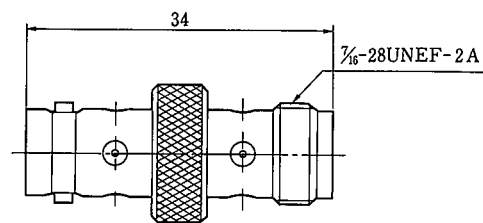

BNC.J-TNC.J
CL311-0194-7

Fig.33

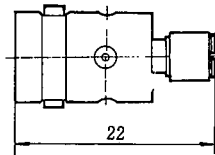

BNCJ-UMP
CL311-0052-2

Fig.34

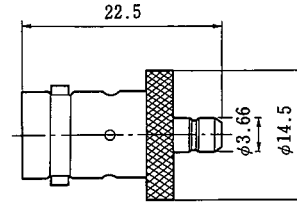

BNCJ-UMJ
CL311-0053-5

Fig.35

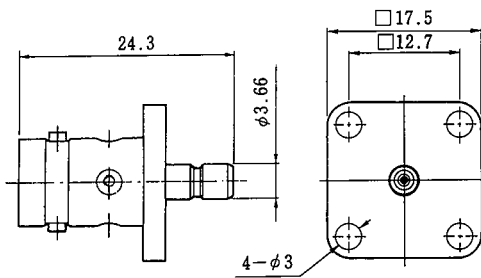

BNCJ-UMJ-PA (04)
CL311-0103-1-04

Fig.36

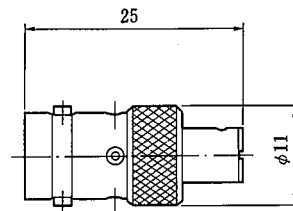

BNCJ-MSSP
CL311-0081-0

Fig.37

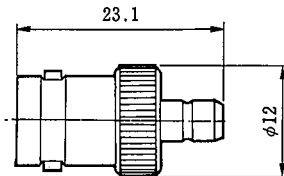

BNCJ-MSSJ
CL311-0066-7

Fig.38

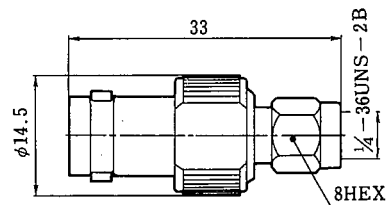

HRM-517 (09)
CL311-0099-6-09

Fig.39

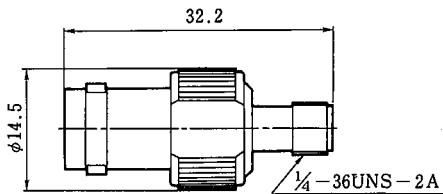

HRM-516 (09)
CL311-0102-9-09

Fig.40

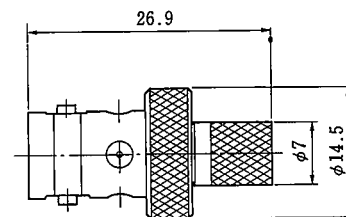

BNCJ-PODP
CL311-0160-5

Fig.41

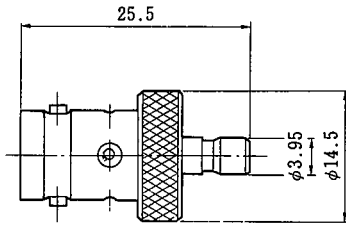

BNCJ-PODJ
CL311-0161-8

Fig.42

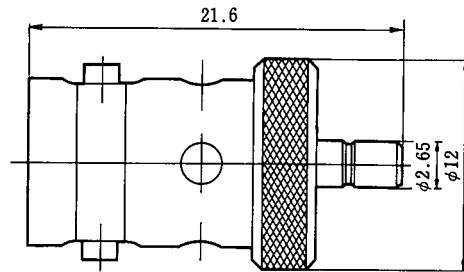

BNCJ-PO6J
CL311-0167-4

Fig.43

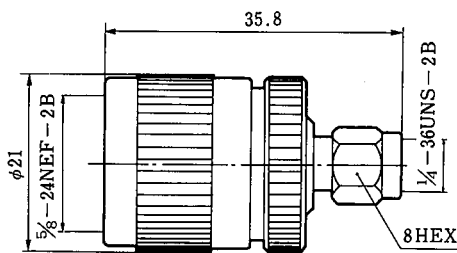

HRM-509 (09)
CL311-0093-0-09

Fig.44

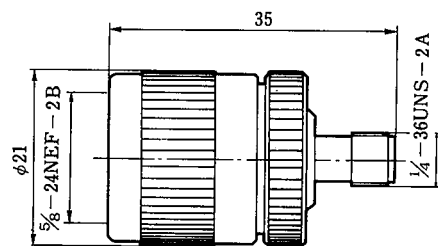

HRM-508 (09)
CL311-0092-7-09

Fig.45

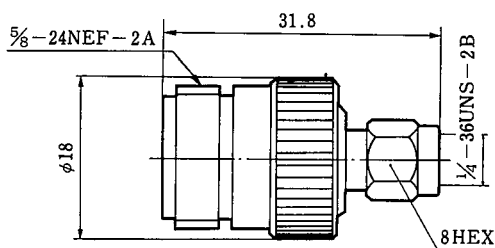

HRM-507 (09)
CL311-0091-4-09

Fig.46

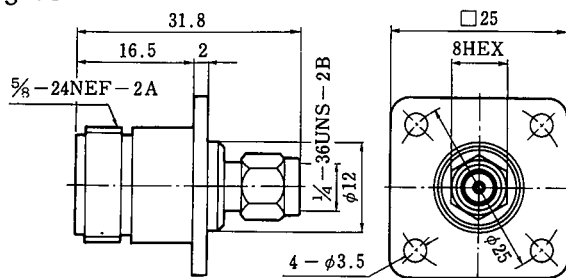

HRM-512 (09)
CL311-0098-3-09

HRM-512S
CL311-0144-9

Fig.47

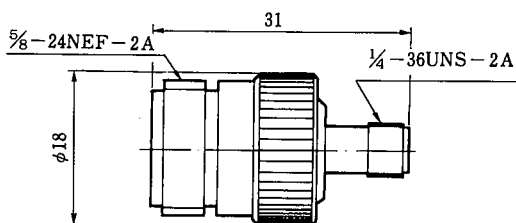

HRM-506 (09)
CL311-0090-1-09

Fig.48

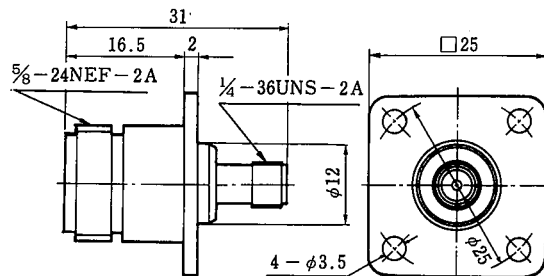

HRM-511 (09)
CL311-0094-2-09

HRM-511S
CL311-0143-6

BWA SERIES RF CO-AXIAL CONNECTORS

<p>Fig.49</p> <p>HRMJ-TNCJ-PA CL311-0202-3</p>	<p>Fig.50</p> <p>UM.P-HRM.J CL311-0176-5</p>
<p>Fig.51</p> <p>HRMJ-UMJ CL311-0164-6</p>	<p>Fig.52</p> <p>HRMP-POBP-1 CL311-0169-0</p>
<p>Fig.53</p> <p>HRMP-POBJ CL311-0152-7</p>	<p>Fig.54</p> <p>HRM.P-POD.J CL311-0177-8</p>
<p>Fig.55</p> <p>HRMP-POD1J CL311-0253-4</p>	<p>Fig.56</p> <p>HRMP-PO6J CL311-0172-4</p>

Fig.57

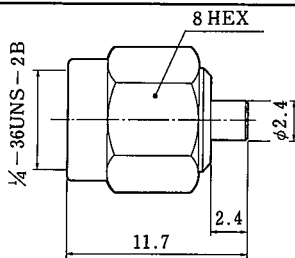

Note : The mating portion on the S. FL side mates with the S. FL and S. FL2 plugs. Having no locking mechanism, however, the S. FL side mating portion can be used only for performance measurement.

HRMP-S.FLJ-2
CL311-0249-7

Fig.58

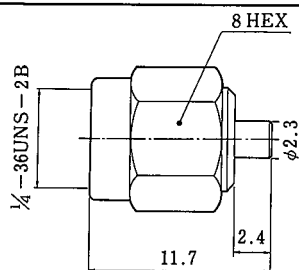

Note : Having no locking mechanism, however, the S. FL side mating portion can be used only for performance measurement.

HRMP-H.FLJ
CL311-0232-4

Fig.59

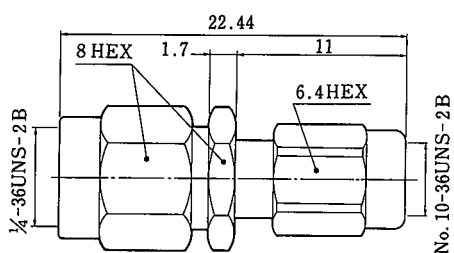

HRMP-HRMMP
CL311-0250-6

Fig.60

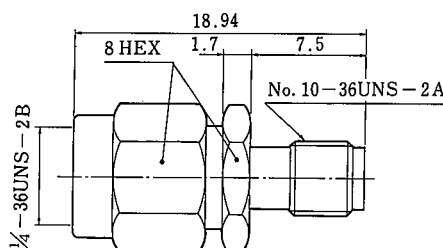

HRMP-HRMMJ
CL311-0243-0

Fig.61

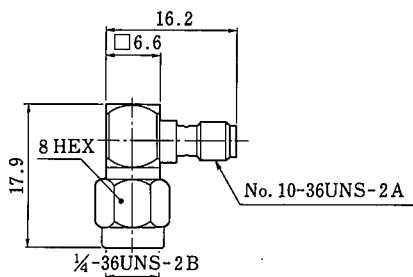

HRMP-HRMMJ-LA
CL311-0226-1

Fig.62

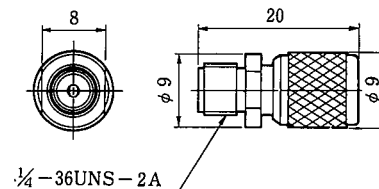

HRMJ-POBP
CL311-0151-4

Fig.63

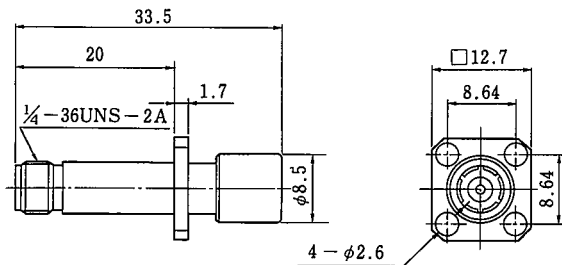

HRMJ-POBP-PA
CL311-0206-4

Fig.64

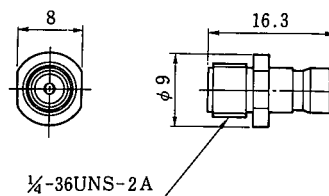

HRMJ-POBJ
CL311-0149-2

Fig.65

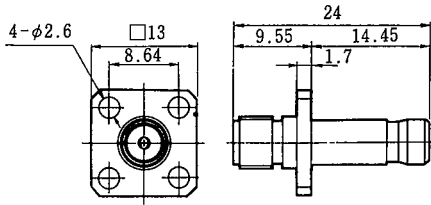

HRMJ-POBJ-PA
CL311-0150-1

Fig.66

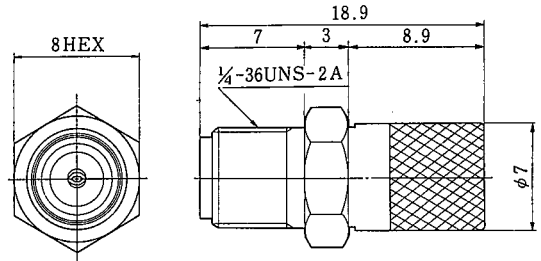

HRMJ-PODP
CL311-0157-0

Fig.67

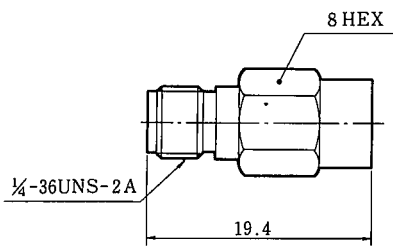

HRMJ-POD1P-1
CL311-0254-7

Fig.68

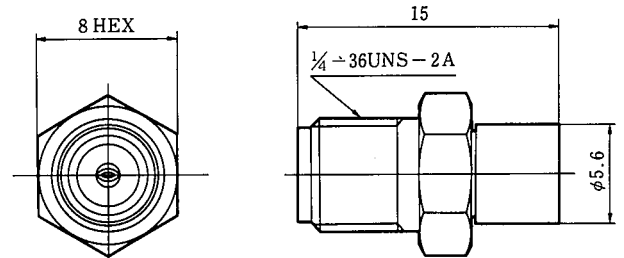

HRMJ-PO6P
CL311-0173-7

Fig.69

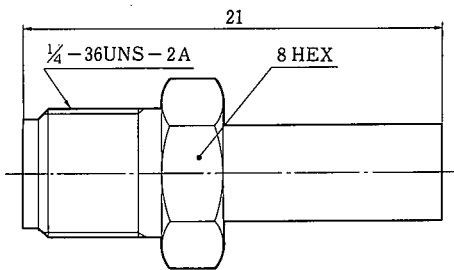

HRMJ-PO51P
CL311-0231-1

Fig.70

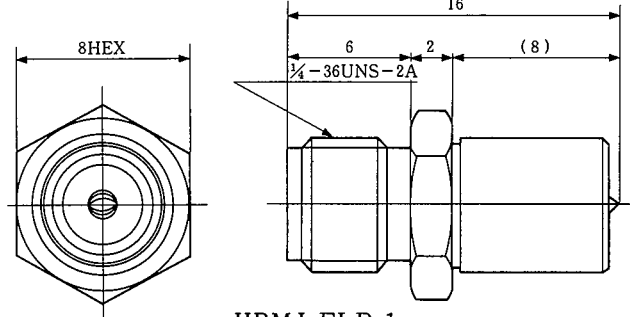

HRMJ-FLP-1
CL311-0195-0

Fig.71

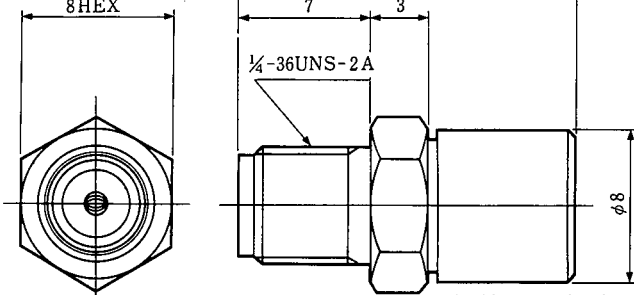

HRMJ-FLJ
CL311-0179-3

Note: Having no locking mechanism, however, the FL side mating portion can be used only for performance measurement.

Fig.72

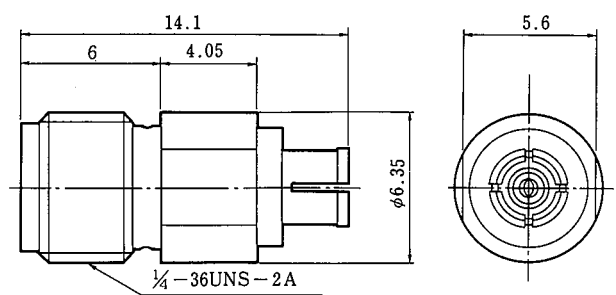

HRMJ-S.FLP
CL311-0218-3

Note: Compatible with S. FL and S. FL2.

BWA SERIES RF CO-AXIAL CONNECTORS

Fig.73

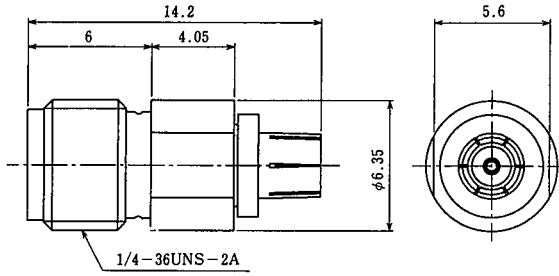

HRMJ-H.FLP-3
CL311-0264-0

Fig.74

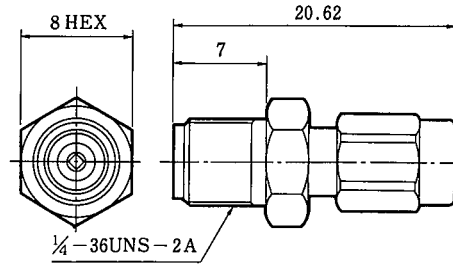

HRMJ-HRMMP-2
CL311-0221-8

Fig.75

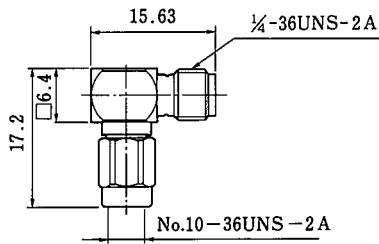

HRMJ-HRMMP-LA
CL311-0227-4

Fig.76

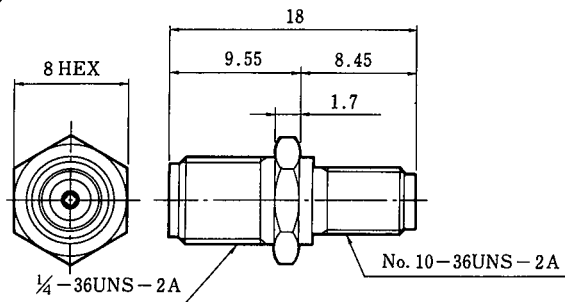

HRMJ-HRMMJ
CL311-0220-5