



Chipsmall Limited consists of a professional team with an average of over 10 year of expertise in the distribution of electronic components. Based in Hongkong, we have already established firm and mutual-benefit business relationships with customers from,Europe,America and south Asia,supplying obsolete and hard-to-find components to meet their specific needs.

With the principle of "Quality Parts,Customers Priority,Honest Operation,and Considerate Service",our business mainly focus on the distribution of electronic components. Line cards we deal with include Microchip,ALPS,ROHM,Xilinx,Pulse,ON,Everlight and Freescale. Main products comprise IC,Modules,Potentiometer,IC Socket,Relay,Connector.Our parts cover such applications as commercial,industrial, and automotives areas.

We are looking forward to setting up business relationship with you and hope to provide you with the best service and solution. Let us make a better world for our industry!



## Contact us

Tel: +86-755-8981 8866 Fax: +86-755-8427 6832

Email & Skype: info@chipsmall.com Web: www.chipsmall.com

Address: A1208, Overseas Decoration Building, #122 Zhenhua RD., Futian, Shenzhen, China





# APPLICATION SPECIFICATION

## TABLE OF CONTENTS

- 1.0 SCOPE
- 2.0 PRODUCT DESCRIPTION
  - 2.1 PRODUCT NAME AND PART NUMBER
- 3.0 REFERENCE DOCUMENTS
- 4.0 PROCEDURE
  - 4.1 GENERAL REQUIREMENTS
    - 4.1.1 LIMITATIONS
    - 4.1.2 MATERIAL
    - 4.1.3 STORAGE
    - 4.1.4 SHELF LIFE
    - 4.1.5 CHEMICAL EXPOSURE
- 5.0 PC BOARD REQUIREMENTS
  - 5.1 MATERIAL THICKNESS
  - 5.2 TOLERANCE
  - 5.3 HOLE DIMENSIONS
  - 5.4 LAYOUT
- 6.0 LIGHT PIPE / LED CLEARANCE REQUIREMENTS
- 7.0 BEZEL REQUIREMENTS
  - 7.0.1 THICKNESS
  - 7.0.2 CUTOUT
  - 7.1 PC BOARD AND BEZEL POSITION
- 8.0 ASSEMBLY PLACEMENT INSTRUCTIONS
  - 8.1 REGISTRATION
  - 8.2 SEATING
  - 8.3 CHECKING ASSEMBLY
  - 8.4 REPAIR AND REWORK
- 9.0 INSERTION AND REMOVAL TOOLING
  - 9.1 SEATING TOOL
  - 9.2 EXTRACTION TOOL
  - 9.3 APPLICATION TOOL
  - 9.4 PC BOARD SUPPORT FIXTURE
- 10.0 VISUAL AIDS

REVISION: <b>G</b>	ECR/ECN INFORMATION: EC No: <b>UCP2011-3934</b> DATE: <b>2011 / 06 / 04</b>	TITLE: <b>Stacked SFP &amp; SFP+ Connectors</b>	SHEET No. <b>1 of 18</b>
DOCUMENT NUMBER: <b>AS-75310-001</b>	CREATED / REVISED BY: <b>Jlong/Jgonzalez</b>	CHECKED BY: <b>Jjantelezio</b>	APPROVED BY: <b>Mbanakis</b>





# APPLICATION SPECIFICATION

## 1.0 SCOPE

This specification covers the requirements for the application of the stacked SFP and SFP+ connector assemblies to interconnect with SFP fiber optic or copper transceiver modules to printed circuit (pc) boards. The connector and cage assembly is a pre-assembled unit available in two heights: a 2x1 extended height (tall) configuration, and 2x1, 2x2, 2x4, 2x5, 2x6 and 2x8 standard height (medium) configurations. The configurations are either with integrated light pipes or no light pipes.

The 2x1 extended height connectors are available in either solder pin contacts or compliant pin contacts for mechanical retention to the pc board. The 2x1 thru 2x8 standard height connectors feature compliant pin contacts for mechanical retention to the pc board. All the connectors provide electromagnetic interference (EMI) suppression, thermal vent holes, and panel ground fingers or a conductive gasket. The connector cage assemblies have a locking latch and a kick-out spring for each mating module. The locking latch holds the module in place, and the kick-out springs help in releasing the module for removal. The connector assembly is designed to be inserted into a bezel after being seated onto the pc board.

Basic terms and features of these products are provided in Figure 1.

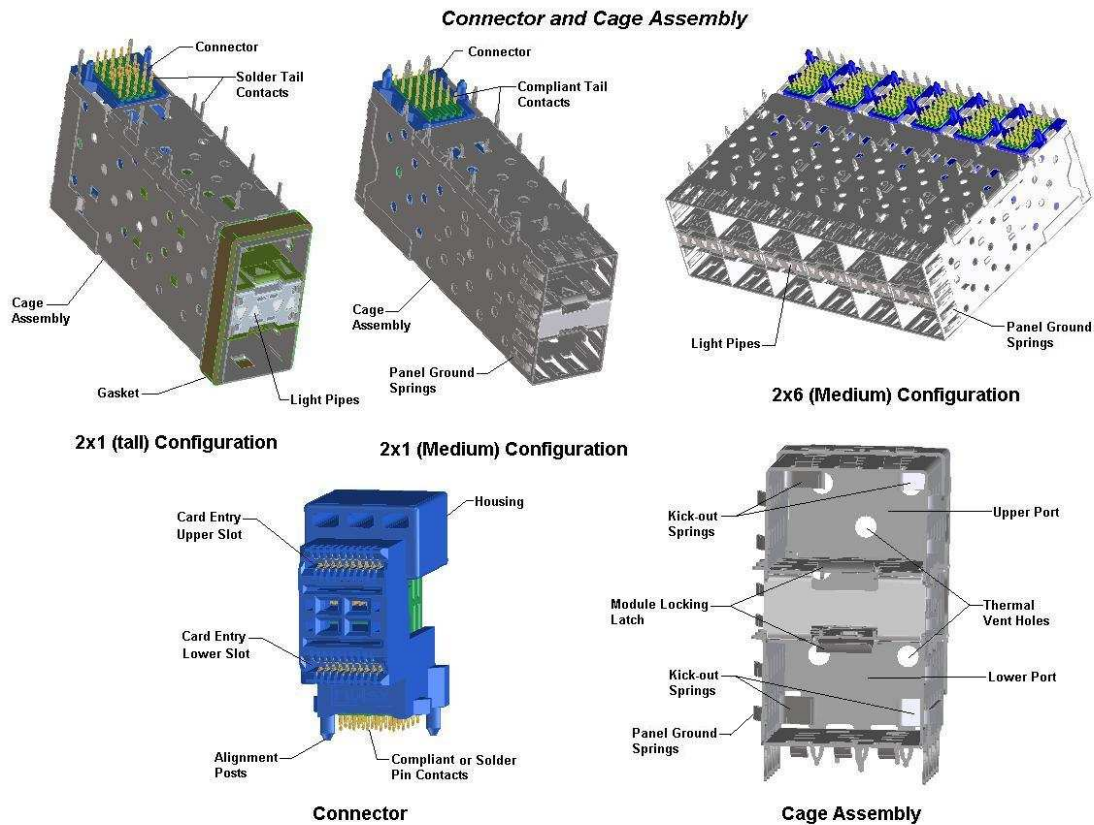

Figure 1

REVISION: <b>G</b>	ECR/ECN INFORMATION: EC No: <b>UCP2011-3934</b> DATE: <b>2011 / 06 / 04</b>	TITLE: <b>Stacked SFP &amp; SFP+ Connectors</b>	SHEET No. <b>2 of 18</b>
DOCUMENT NUMBER: <b>AS-75310-001</b>	CREATED / REVISED BY: <b>Jlong/Jgonzalez</b>	CHECKED BY: <b>Jjantelezio</b>	APPROVED BY: <b>Mbanakis</b>



# APPLICATION SPECIFICATION

## 2.0 PRODUCT DESCRIPTION

The connector consists of a housing with dual 20-position receptacle ports and with either solder pin contacts or compliant pin contacts on 0.8mm centerline spacing. The housing features alignment posts that provide stability for placement on the pc board. Each receptacle has a card entry slot that accepts a 1.0 +/-0.1mm thick integrated circuit card housed in the mating module transceiver.

## 2.1 PRODUCT NAME AND PART NUMBER

### 2.1.1 STACKED SFP PRODUCT NAME AND DRAWING NUMBER

Height	Product Name with light pipes	Drawing Number
Extended	2x1 thru-hole connector with flange (40 ckt)	SD-75310-100
Extended	2x1 thru-hole connector w/extended flange (40 ckt)	SD-75460-001
Extended	2x1 press-fit connector with flange (40 ckt)	SD-75786-001
Extended	2x1 press-fit connector w/extended flange (40 ckt)	SD-75787-001
Standard	2x1 press-fit connector w/EMI fingers (40 ckt)	SD-75640-00*
Standard	2x2 press-fit connector w/EMI fingers (80 ckt)	SD-75714-00*
Standard	2x4 press-fit connector w/EMI fingers (160 ckt)	SD-75450-00*
Standard	2x5 press-fit connector w/EMI fingers (200 ckt)	SD-75734-00*
Standard	2x6 press-fit connector w/EMI fingers (240 ckt)	SD-75451-00*

Height	Product Name without light pipes	Drawing Number
Standard	2x1 press-fit connector w/EMI fingers (40 ckt)	SD-75462-100
Standard	2x2 press-fit connector w/EMI fingers (80 ckt)	SD-75759-00*
Standard	2x4 press-fit connector w/EMI fingers (160 ckt)	SD-75454-00*
Standard	2x5 press-fit connector w/EMI fingers (200 ckt)	SD-75733-00*
Standard	2x6 press-fit connector w/EMI fingers (240 ckt)	SD-75477-***

### 2.1.2 STACKED SFP+ PRODUCT NAME AND DRAWING NUMBER

Height	Product Name w/ metal gasket & light pipes	Drawing Number
Standard	2x1 press-fit connector (40 ckt)	SD-76044-001
Standard	2x2 press-fit connector (80 ckt)	SD-76045-001
Standard	2x4 press-fit connector (160 ckt)	SD-76046-001
Standard	2x5 press-fit connector (200 ckt)	SD-76047-001
Standard	2x6 press-fit connector (240 ckt)	SD-76048-001
Standard	2x8 press-fit connector (320 ckt)	SD-76352-001

Height	Product Name w/ metal gasket, no light pipes	Drawing Number
Standard	2x1 press-fit connector (40 ckt)	SD-76064-001
Standard	2x2 press-fit connector (80 ckt)	SD-76065-001
Standard	2x4 press-fit connector (160 ckt)	SD-76066-001
Standard	2x5 press-fit connector (200 ckt)	SD-76067-001
Standard	2x6 press-fit connector (240 ckt)	SD-76068-001
Standard	2x6 press-fit connector (240 ckt)	SD-76200-001

Height	Product Name w/ elastomeric gasket & light pipes	Drawing Number
Standard	2x1 press-fit connector (40 ckt)	SD-76090-001
Standard	2x2 press-fit connector (80 ckt)	SD-76091-001
Standard	2x4 press-fit connector (160 ckt)	SD-76092-001
Standard	2x5 press-fit connector (200 ckt)	SD-76093-001
Standard	2x6 press-fit connector (240 ckt)	SD-76094-001

REVISION: <b>G</b>	ECR/ECN INFORMATION: EC No: <b>UCP2011-3934</b> DATE: <b>2011 / 06 / 04</b>	TITLE: <b>Stacked SFP &amp; SFP+ Connectors</b>	SHEET No. <b>3 of 18</b>
DOCUMENT NUMBER: <b>AS-75310-001</b>	CREATED / REVISED BY: <b>Jlong/Jgonzalez</b>	CHECKED BY: <b>Jjantelezio</b>	APPROVED BY: <b>Mbanakis</b>



# APPLICATION SPECIFICATION

Height	Product Name w/ elastomeric gasket, no light pipes	Drawing Number
Standard	2x1 press-fit connector (40 ckt)	SD-76100-001
Standard	2x2 press-fit connector (80 ckt)	SD-76101-001
Standard	2x4 press-fit connector (160 ckt)	SD-76102-001
Standard	2x5 press-fit connector (200 ckt)	SD-76103-001
Standard	2x6 press-fit connector (240 ckt)	SD-76104-001

### 3.0 REFERENCE DOCUMENTS

Refer to the appropriate customer sales drawing for product part numbers.  
Refer to PS-75310-001 for the SFP/SFP+ Multi-port Connectors product spec.  
Refer to Small Form-factor Pluggable (SFP) Transceiver Multi Source Agreement (MSA)

### 4.0 PROCEDURE

#### 4.1 GENERAL REQUIREMENTS

**4.1.1 Limitations** The connectors are designed to operate in a temperature range of -40° to 85°C [-40° to 185° F].

The bezel requirements given in this document are specifically configured for products used in the communications industry. It is strongly recommended that this bezel configuration NOT be used for peripheral component interconnect (PCI) applications.

**4.1.2 Material** The connector housing and wafers (parts that hold the terminal contacts) are made of molded thermoplastic, UL 94-V-0.  
All terminal contacts in the connector are made of brass under-plated with nickel, plated with tin at the leads and plated with gold at the interface area.  
The light pipes are made of polycarbonate, UL 94-V-0.  
The light pipe housing is made of zinc plated with nickel and under-plated with copper.  
The cage assembly is made of a nickel silver alloy.

**4.1.3 Storage** Prolonged exposure to ultraviolet light may deteriorate the chemical composition used in the connector material.

**4.1.4 Shelf Life** The connector assembly should remain in the shipping container until ready for use to prevent deformation to the contact leads, ground tails and mounting posts. The connector assemblies should be used on a first in, first out basis to avoid storage contamination that could adversely affect performance.

**4.1.5 Chemical Exposure** Do not store connector assemblies near any chemicals listed below as they may cause stress corrosion cracking in the terminal contacts or mounting posts.

Alkalies	Ammonia	Citrates	Phosphates	Citrates	Sulfur Compounds
Amines	Carbonates	Nitrites	Sulfur Nitrites		Tartrates

REVISION: <b>G</b>	ECR/ECN INFORMATION: EC No: <b>UCP2011-3934</b> DATE: <b>2011 / 06 / 04</b>	TITLE: <b>Stacked SFP &amp; SFP+ Connectors</b>	SHEET No. <b>4 of 18</b>
DOCUMENT NUMBER: <b>AS-75310-001</b>	CREATED / REVISED BY: <b>Jlong/Jgonzalez</b>	CHECKED BY: <b>Jjantelezio</b>	APPROVED BY: <b>Mbanakis</b>



# APPLICATION SPECIFICATION

## 5.0 PC BOARD REQUIREMENTS

### 5.1 MATERIAL THICKNESS

The pc board material shall be glass epoxy (FR-4 or G-10). The minimum pc board thickness shall be 2.36 mm (0.093”).

### 5.2 TOLERANCE

Maximum allowable bow of the pc board shall be 0.08 mm over the length of the connector assembly.

### 5.3 HOLE DIMENSIONS

The holes for the connector assembly must be drilled and plated through to dimensions specified in Figure 2.

### 5.4 LAYOUT

The holes for the connector assembly must be precisely located to ensure proper placement and optimum performance of the connector assembly. Recommended hole patterns, dimensions, and tolerances are provided in Figures 3a, 3b and 3c.

### Recommended Hole Dimensions

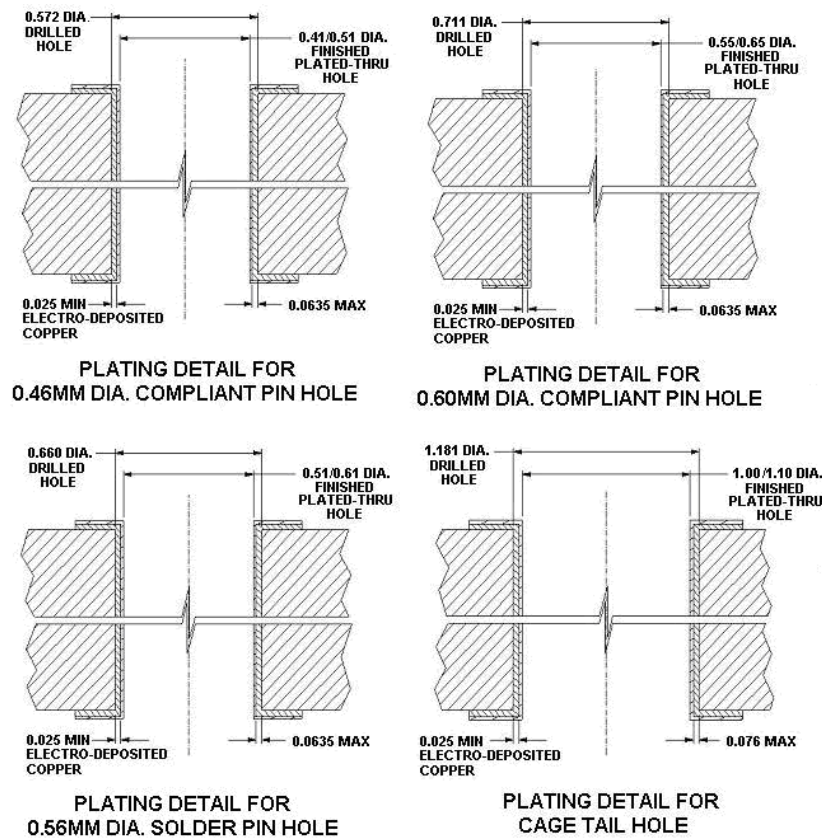

**Figure 2**  
**Recommended PC Board Layout for 2x1 thru 2x6 Standard Height Assemblies**

REVISION: <b>G</b>	ECR/ECN INFORMATION: EC No: <b>UCP2011-3934</b> DATE: <b>2011 / 06 / 04</b>	TITLE: <b>Stacked SFP &amp; SFP+ Connectors</b>	SHEET No. <b>5 of 18</b>
DOCUMENT NUMBER: <b>AS-75310-001</b>	CREATED / REVISED BY: <b>Jlong/Jgonzalez</b>	CHECKED BY: <b>Jjantelezio</b>	APPROVED BY: <b>Mbanakis</b>



# APPLICATION SPECIFICATION

## Without Light Pipes

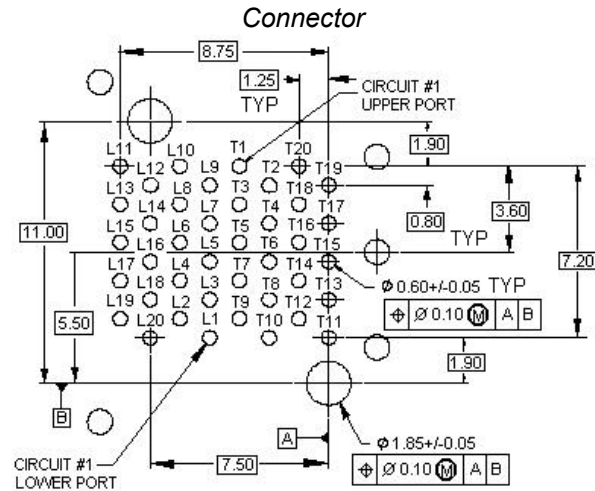

**CONNECTOR LAYOUT FOR 0.60MM DIA.  
COMPLIANT PIN HOLES**

## Connector and cage assembly 2x4 Configuration Shown

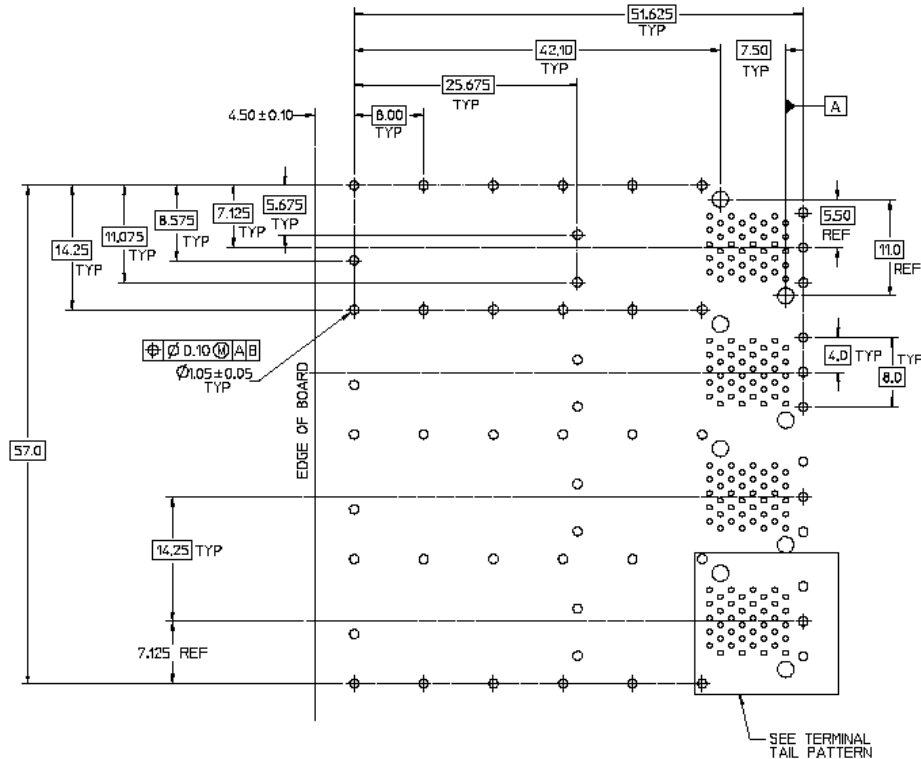

**Figure 3a**

**Recommended PC Board Layout for 2x1 thru 2x8 Standard Height Assemblies**

REVISION: <b>G</b>	ECR/ECN INFORMATION: EC No: <b>UCP2011-3934</b> DATE: <b>2011 / 06 / 04</b>	TITLE: <b>Stacked SFP &amp; SFP+ Connectors</b>	SHEET No. <b>6 of 18</b>
DOCUMENT NUMBER: <b>AS-75310-001</b>	CREATED / REVISED BY: <b>Jlong/Jgonzalez</b>	CHECKED BY: <b>Jjantelezio</b>	APPROVED BY: <b>Mbanakis</b>



# APPLICATION SPECIFICATION

## With Light Pipes

### Connector

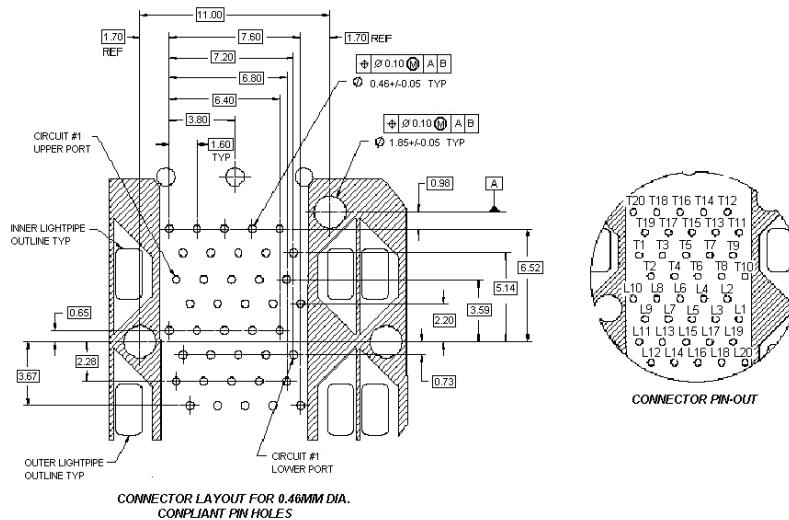

### Connector and cage assembly 2x4 Configuration Shown

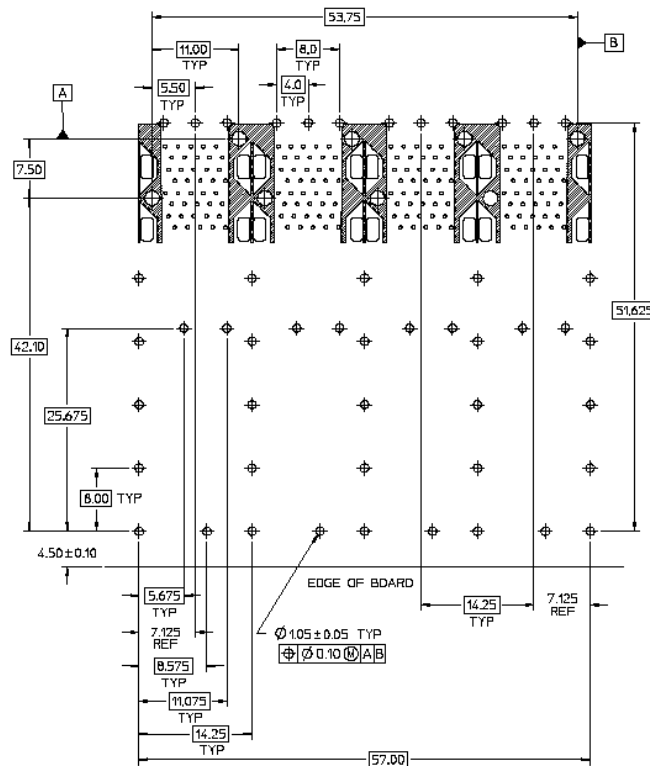

Figure 3b

### Recommended PC Board Layout for 2x1 Extended Height Assemblies

REVISION: <b>G</b>	ECR/ECN INFORMATION: EC No: <b>UCP2011-3934</b> DATE: <b>2011 / 06 / 04</b>	TITLE: <b>Stacked SFP &amp; SFP+ Connectors</b>	SHEET No. <b>7 of 18</b>
DOCUMENT NUMBER: <b>AS-75310-001</b>	CREATED / REVISED BY: <b>Jlong/Jgonzalez</b>	CHECKED BY: <b>Jjantelezio</b>	APPROVED BY: <b>Mbanakis</b>





# APPLICATION SPECIFICATION

## With Light Pipes

### Connector

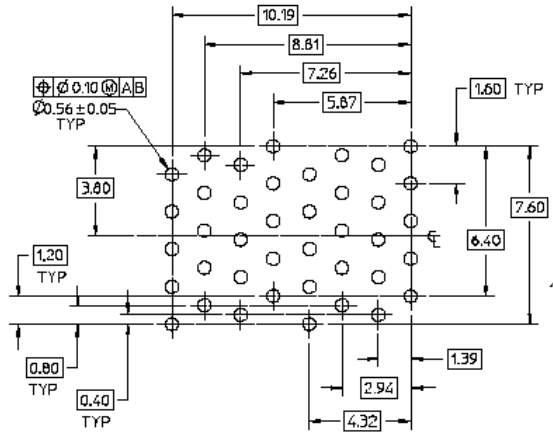

CONNECTOR LAYOUT FOR 0.56MM DIA. COMPLIANT OR SOLDER PIN HOLES

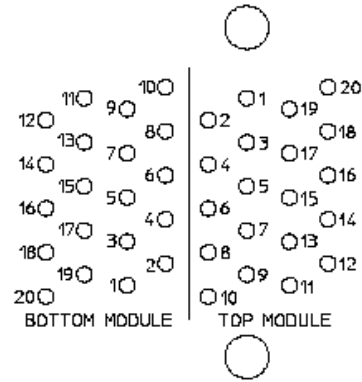

CONNECTOR PINOUT

### Connector and cage assembly 2 x 1 Configuration

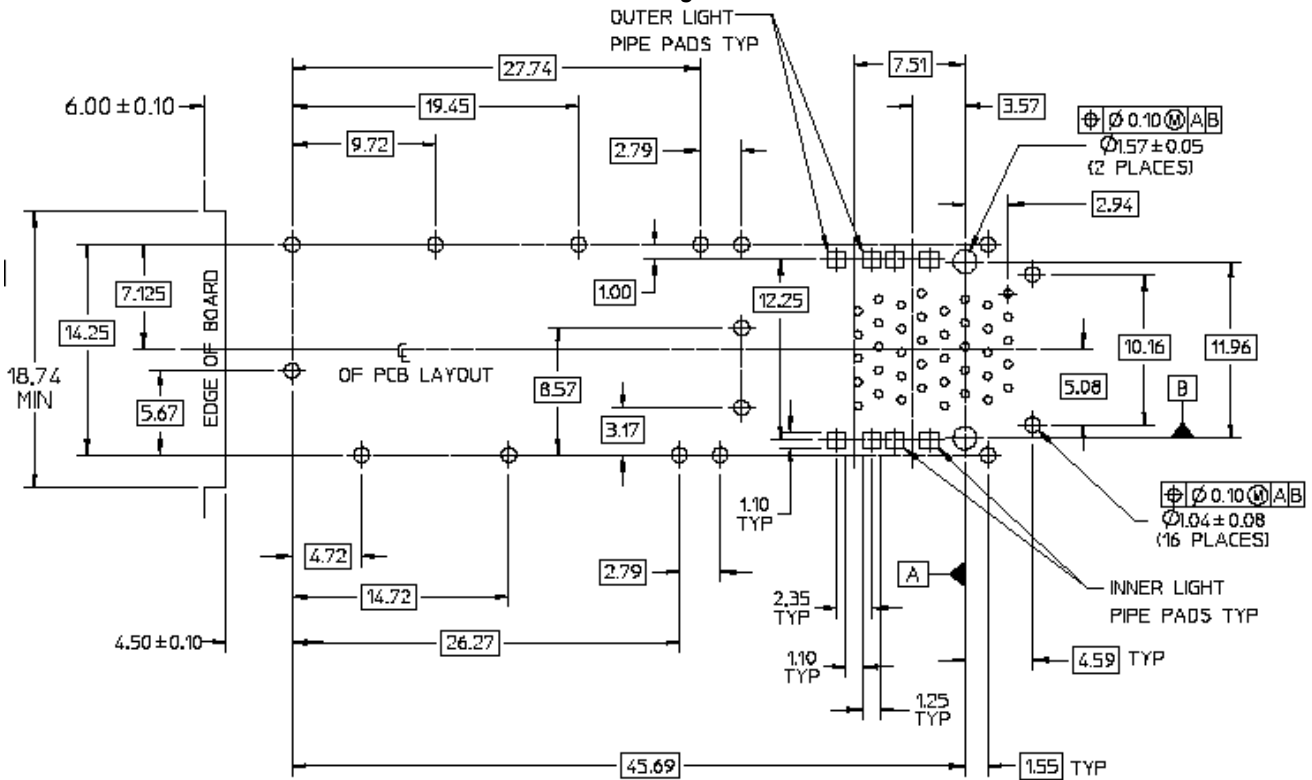

Figure 3c

## 6.0 LIGHT PIPE / LED CLEARANCE REQUIREMENTS

REVISION:	ECR/ECN INFORMATION:	TITLE:	SHEET No.
<b>G</b>	EC No: UCP2011-3934 DATE: 2011 / 06 / 04	<b>Stacked SFP &amp; SFP+ Connectors</b>	<b>8 of 18</b>
DOCUMENT NUMBER:	CREATED / REVISED BY:	CHECKED BY:	APPROVED BY:
<b>AS-75310-001</b>	<b>Jlong/Jgonzalez</b>	<b>Jjantelezio</b>	<b>Mbanakis</b>



# APPLICATION SPECIFICATION

Extended Height Light Pipe Assembly version shown for illustration purposes

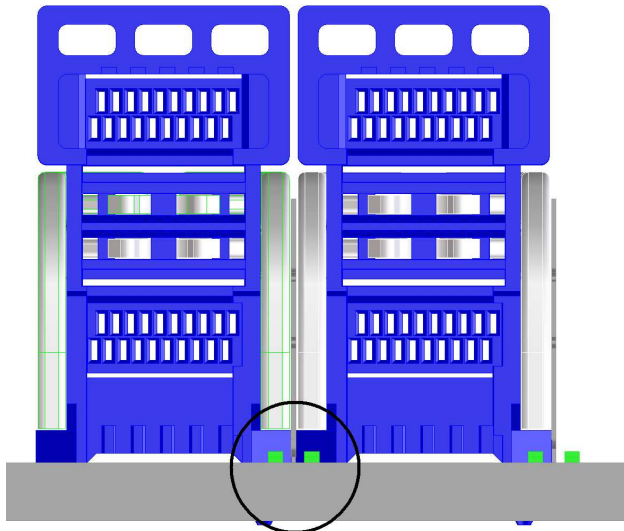

**Figure 4a**

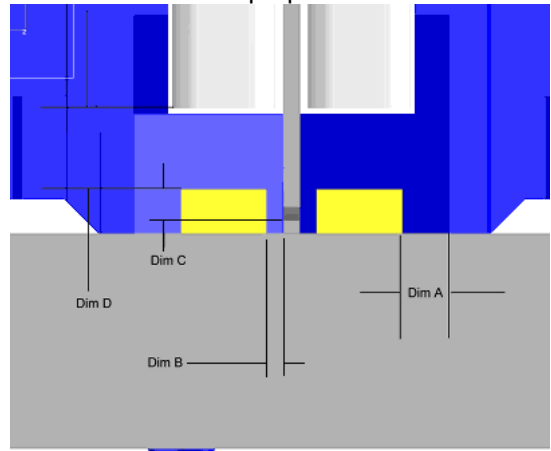

**Figure 4b**

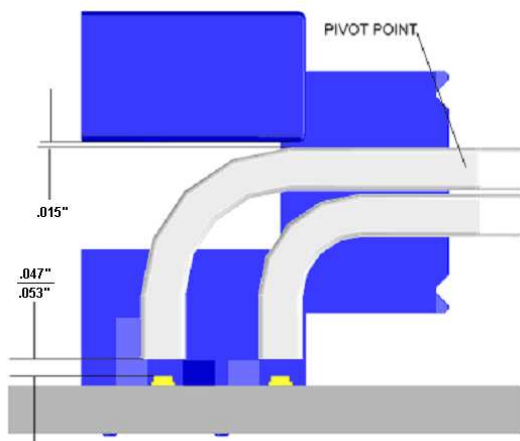

Light Pipes for Extended Assemblies  
**Figure 4c**

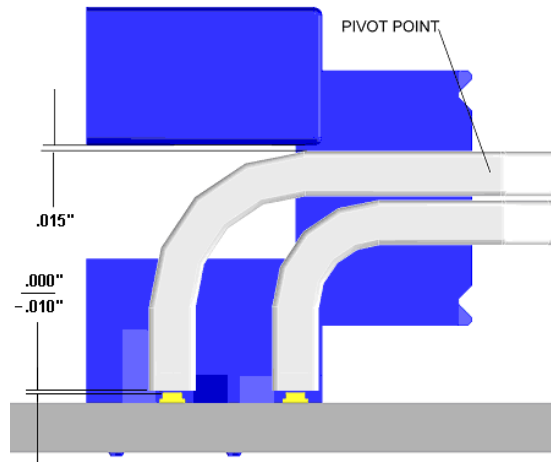

Light Pipes for Standard Assemblies  
**Figure 4d**

## LED PACKAGE CLEARANCE

REVISION: <b>G</b>	ECR/ECN INFORMATION: EC No: <b>UCP2011-3934</b> DATE: <b>2011 / 06 / 04</b>	TITLE: <b>Stacked SFP &amp; SFP+ Connectors</b>	SHEET No. <b>9 of 18</b>
DOCUMENT NUMBER: <b>AS-75310-001</b>	CREATED / REVISED BY: <b>Jlong/Jgonzalez</b>	CHECKED BY: <b>Jjantelezio</b>	APPROVED BY: <b>Mbanakis</b>



# APPLICATION SPECIFICATION

The following are the recommended LED packages to be used with the Molex Stacked SFP and SFP+ connector assemblies. Refer to Figures 4a and 4b.

Package	Horizontal Clearance With housing Dim A (in)	Horizontal Clearance With Vertical Support Dim B (in)	Top of LED to Bottom of Vertical Support Dim C (in)	Top of LED to Bottom of Light Pipe Tall / Medium Dim D (in)
0402	0.0424	0.0246	0.0027	0.053 / -0.005
0603	0.0365	0.0187	0.0056	0.049 / -0.009
0605	0.0277	0.0098	0.0076	0.0471 / -0.0109
0805 Low Profile	0.0277	0.0098	0.0217	----- / -0.0166

The gap between the light pipe and the LED is .053" to .047" depending on LED package for the extended height assemblies and .000" to -.010" for the standard height assemblies. The extended light pipes are intended to rest on top of the LED as shown in dimension D of the chart for all the standard height assemblies. This provides the maximum amount of light transmission through the light pipe. The light pipes are designed to pivot at a point in front of the housing, which gives the light pipe a long enough arm to flex a small amount without undue stress. Refer to Figures 4c and 4d.

## 7.0 BEZEL REQUIREMENTS

### 7.0.1 THICKNESS

The bezel thickness range shall be 0.8 mm thru 2.6 mm.

### 7.0.2 CUTOUT

The bezel must provide a cutout that allows proper mounting of the connector assembly. The cage assembly panel ground springs must be compressed by the bezel in order to provide and electrical ground between the connector assembly and bezel for EMI suppression. In a case where a gasket is used, the gasket should be compressed enough when the connector assembly is in its final seated position in the bezel cutout for EMI suppression. Care must be used to avoid interference between adjacent connector and cage assemblies and other components. The minimum allowable distance between connector assemblies must be considered to ensure proper assembly. Dimensions for bezel cutout and minimum allowable distance between cutouts are shown in Figure 5.

## 7.1 PC BOARD AND BEZEL POSITION

REVISION: <b>G</b>	ECR/ECN INFORMATION: EC No: <b>UCP2011-3934</b> DATE: <b>2011 / 06 / 04</b>	TITLE: <b>Stacked SFP &amp; SFP+ Connectors</b>	SHEET No. <b>10 of 18</b>
DOCUMENT NUMBER: <b>AS-75310-001</b>	CREATED / REVISED BY: <b>Jlong/Jgonzalez</b>	CHECKED BY: <b>Jjantelezio</b>	APPROVED BY: <b>Mbanakis</b>



# APPLICATION SPECIFICATION

The bezel and pc board must be positioned in relation to each other to avoid interference with the function of the cage assembly module locking latch and to ensure proper function of the panel ground springs or the gasket. This relationship must conform to the dimensions stated in Figure 5.

## Recommended Bezel Cutout and PC Board and Bezel Position

Bezel Thickness 0.8 – 2.6

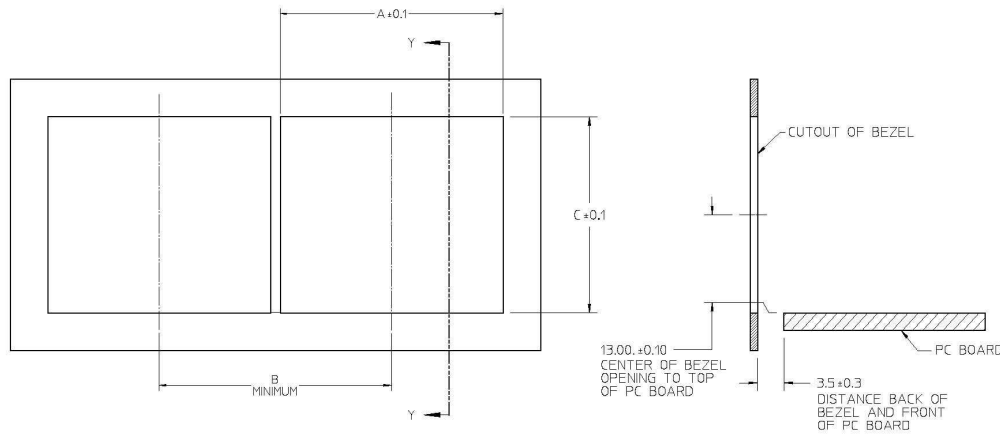

Figure 5

CONNECTOR ASSEMBLY			DIMENSIONS		
HEIGHT	CONFIGURATION	TYPE	A	B (MIN.)	C
Extended	2X1	SFP	15.25	16.90	29.78
		SFP Ext. Flange	15.25	18.70	30.02
Standard	2X1	SFP	15.25	16.40	26.00
		SFP+ Metal Gasket	15.50	17.27	
		SFP+ Elastomeric Gasket	15.50	20.40	
	2X2	SFP	29.50	30.65	
		SFP+ Metal Gasket	29.75	31.52	
		SFP+ Elastomeric Gasket	29.75	34.65	
	2X4	SFP	58.00	59.15	
		SFP+ Metal Gasket	58.25	60.02	
		SFP+ Elastomeric Gasket	58.25	63.15	
	2X5	SFP	72.25	73.40	
		SFP+ Metal Gasket	72.50	74.27	
		SFP+ Elastomeric Gasket	72.50	77.40	
	2X6	SFP	86.50	87.65	
		SFP+ Metal Gasket	86.75	88.52	
SFP+ Elastomeric Gasket		86.75	91.65		
2X8	SFP+ Metal Gasket	115.25	117.02		

## 8.0 ASSEMBLY PLACEMENT INSTRUCTIONS

REVISION: <b>G</b>	ECR/ECN INFORMATION: EC No: <b>UCP2011-3934</b> DATE: <b>2011 / 06 / 04</b>	TITLE: <b>Stacked SFP &amp; SFP+ Connectors</b>	SHEET No. <b>11 of 18</b>
DOCUMENT NUMBER: <b>AS-75310-001</b>	CREATED / REVISED BY: <b>Jlong/Jgonzalez</b>	CHECKED BY: <b>Jjantelezio</b>	APPROVED BY: <b>Mbanakis</b>



# APPLICATION SPECIFICATION

The following requirements also apply to the connector assemblies used for rework purposes.

**CAUTION** Connector assemblies should be handled by the overall cage to avoid deformation, contamination, or damage to the terminal pin contacts, cage ground contacts and the panel ground springs.

## 8.1 Registration

The compliant or solder pin contacts and mounting posts must be aligned with matching holes in the pc board simultaneously to prevent any twisting or bending of the pin contacts.

## 8.2 Seating

Using proper seating force and seating height is essential to interconnection performance. The force used to seat the connector assembly must be applied evenly to prevent deformation or other damage to the pin contacts. The force required to seat the connector assembly onto the pc board can be calculated by:

Amount of compliant pin contacts x 44.5 N [10 lbs] (Force per Compliant Pin Contact = Seating Force)

**CAUTION** Over-driving of the connector assembly will deform parts critical to the quality of the connector. Maximum force occurs prior to the connector assembly bottoming on the pc board.

The shut height of the application tool must be specifically set for proper seating of the connector assembly. The shut height can be calculated by:

Seating Height (Connector Assembly Seated) + Height of Seating Tool (loaded onto Connector Assembly) + Combined Thickness of PC Board and PC Board Support Fixture = Shut Height (Ram Down)

The seating height, measured from the top of the cage assembly (not including the panel ground springs) to the top of the pc board, is given in Figure 6.

The connector assembly must be seated on the pc board not exceeding the dimensions shown in Figure 6.

**NOTE** The shut height may need to be adjusted to obtain the 0.10 mm [0.004 in.] maximum gap between the standoffs if the cage assembly and the pc board.

### 2x1 thru 2x6 Standard Height Connector Assemblies

REVISION: <b>G</b>	ECR/ECN INFORMATION: EC No: <b>UCP2011-3934</b> DATE: <b>2011 / 06 / 04</b>	TITLE: <b>Stacked SFP &amp; SFP+ Connectors</b>	SHEET No. <b>12 of 18</b>
DOCUMENT NUMBER: <b>AS-75310-001</b>	CREATED / REVISED BY: <b>Jlong/Jgonzalez</b>	CHECKED BY: <b>Jjantelezio</b>	APPROVED BY: <b>Mbanakis</b>





# APPLICATION SPECIFICATION

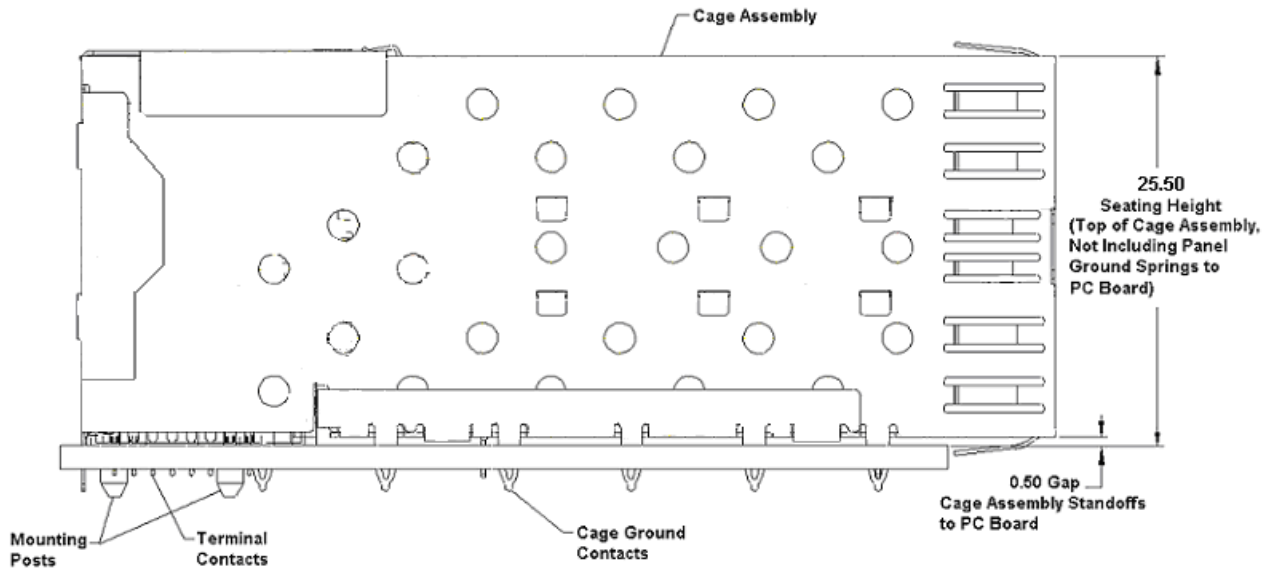

**2x1 Extended Height Connector Assemblies**

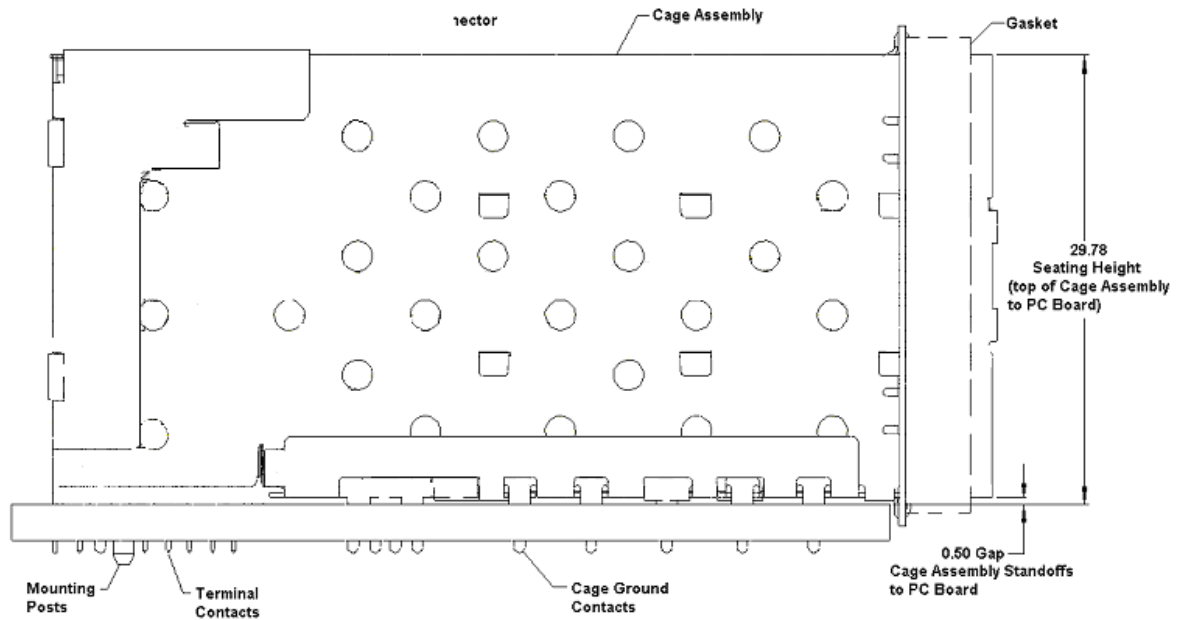

**Figure 6**

### 8.3 Checking Assembly

REVISION: <b>G</b>	ECR/ECN INFORMATION: EC No: <b>UCP2011-3934</b> DATE: <b>2011 / 06 / 04</b>	TITLE: <b>Stacked SFP &amp; SFP+ Connectors</b>	SHEET No. <b>13 of 18</b>
DOCUMENT NUMBER: <b>AS-75310-001</b>	CREATED / REVISED BY: <b>Jlong/Jgonzalez</b>	CHECKED BY: <b>Jjantelezio</b>	APPROVED BY: <b>Mbanakis</b>



# APPLICATION SPECIFICATION

After assembly, the standard height connector assembly panel ground springs must be compressed by the bezel. A slight bow in the cage connector assembly is permitted. On the extended height connector assembly the gasket must compress up against the back face of the bezel. The bezel must not interfere with the function of the module-locking latch. The bezel and pc board must be positioned according to the dimensions shown in Figure 7.

## 2x1 thru 2x6 Standard Height Connector Assemblies

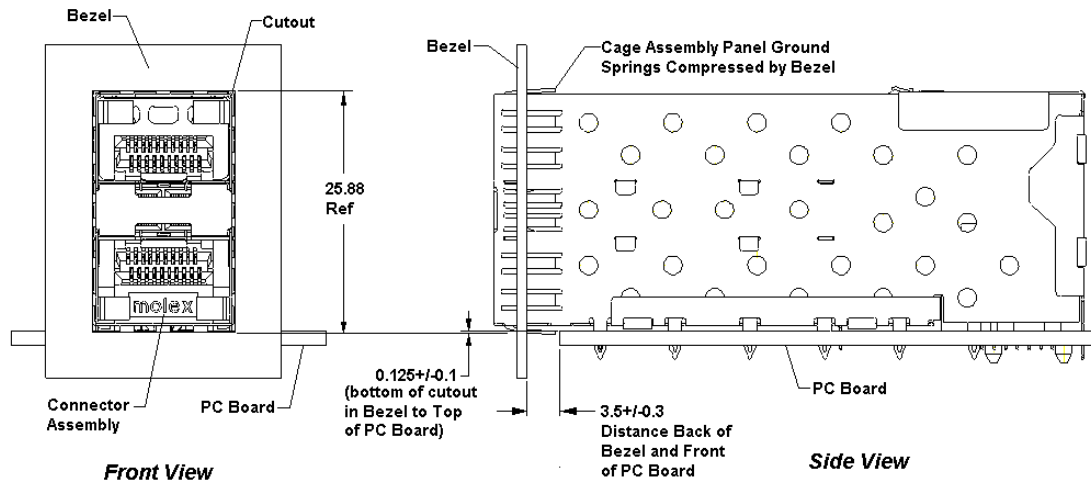

## 2x1 Extended Height Connector Assemblies

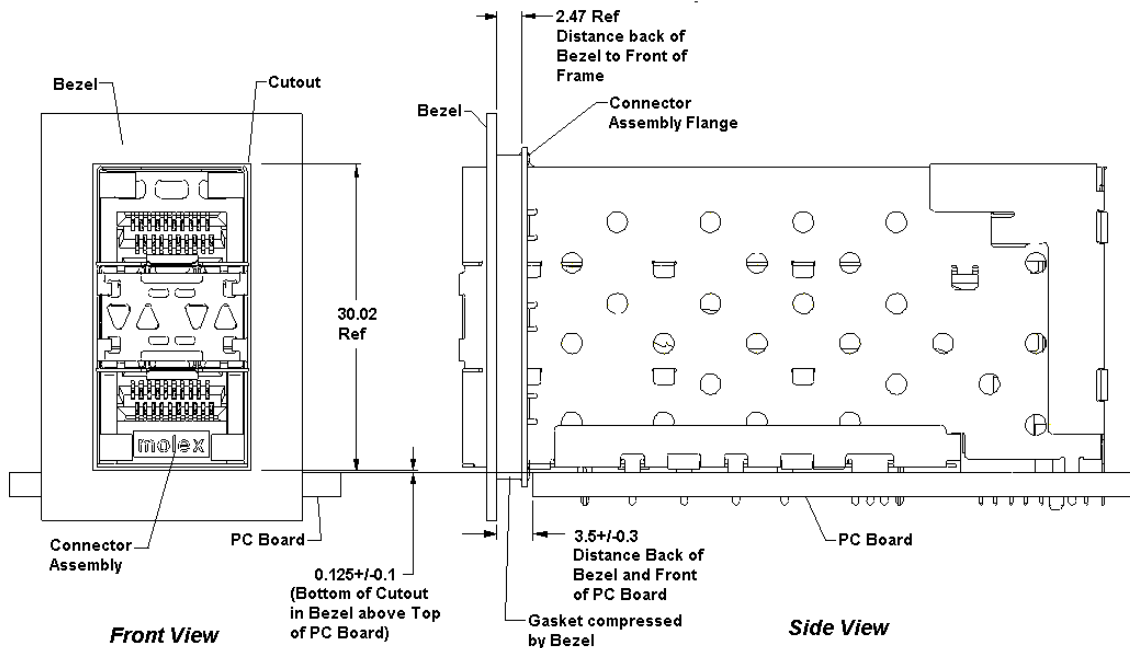

Figure 7

### 8.4 Repair and Rework

REVISION:	ECR/ECN INFORMATION:	TITLE:	SHEET No.
<b>G</b>	EC No: UCP2011-3934 DATE: 2011 / 06 / 04	<b>Stacked SFP &amp; SFP+ Connectors</b>	<b>14 of 18</b>
DOCUMENT NUMBER:	CREATED / REVISED BY:	CHECKED BY:	APPROVED BY:
<b>AS-75310-001</b>	<b>Jlong/Jgonzalez</b>	<b>Jjantelezio</b>	<b>Mbanakis</b>



# APPLICATION SPECIFICATION

Damaged or defective connector assemblies must be removed and replaced.

If repair or rework to the pc board requires soldering after the connector assembly has been seated onto the pc board, the following must apply:

After soldering, removal of fluxes, residues and activators is necessary. Consult with the supplier of the solder and flux for recommended cleaning solvents. Cleaners must be free of dissolved flux and other contaminants. Even the using a "no clean" solder paste; it is imperative that the contact interface be kept clean of flux and residue (since it acts as an insulator).

**DANGER** Consideration must be given to toxicity and other safety requirements recommended by the solvent manufacture. Refer to the manufacture's Material Safety Data Sheet (MSDS) for characteristics and handling of cleaners. Trichloroethylene and Methylene Chloride is not recommended because of harmful occupational and environmental effects. Both are

Air-drying is recommended. Otherwise, make sure that temperature limitations are not exceeded: -55° to 85°C [-67° to 185° F]. Excessive temperatures may cause connector housing and light pipe degradation.

## 9.0 INSERTION AND REMOVAL TOOLING

Tooling part numbers: refer to instruction sheet 62202-9999 for installation and removal of stacked SFP and SFP+ connectors given in Figure 8.

### 9.1 Seating Tool

The seating tool kits (each consists of a seating tool and wall support) are used to seat the connector assembly onto the pc board. The seating tool and support wall is available as a single unit. For rework purposes, the seating tool can be used to seat the connector assembly.

### 9.2 Extraction Tool

The extraction tool is used to remove the connector assembly from the pc board by pulling the contacts out of their holes without overstressing the contacts.

### 9.3 Application Tool

Power for the seating tool and extraction tool must be provided by an application tool (with a ram) capable of supplying a downward force of 44.5 N [10 lb] per contact.

### 9.4 PC Board Support Fixture

A pc board support must be used with the seating tool and the extraction tool. The support fixture provides proper support for the pc board and protects the pc board and the connector assembly from damage. The support fixture must be customer designed. It is recommended that the support fixture be at least 25.4mm longer and wider than the pc board and have flat surfaces with holes or a channel large enough and deep enough to receive any protruding components of the connector assembly.

REVISION: <b>G</b>	ECR/ECN INFORMATION: EC No: <b>UCP2011-3934</b> DATE: <b>2011 / 06 / 04</b>	TITLE: <b>Stacked SFP &amp; SFP+ Connectors</b>	SHEET No. <b>15 of 18</b>
DOCUMENT NUMBER: <b>AS-75310-001</b>	CREATED / REVISED BY: <b>Jlong/Jgonzalez</b>	CHECKED BY: <b>Jjantelezio</b>	APPROVED BY: <b>Mbanakis</b>



# APPLICATION SPECIFICATION

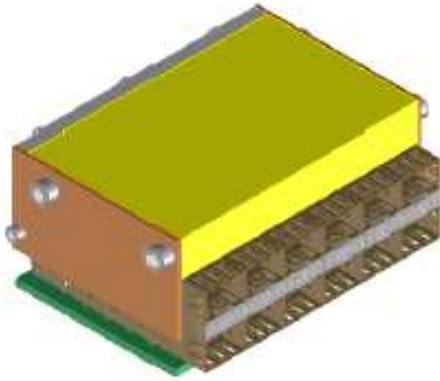

**INSERTION TOOL**

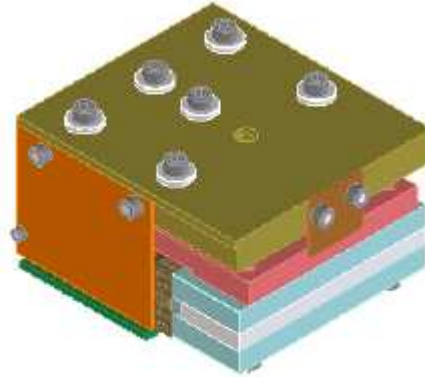

**REMOVAL TOOL**

CONNECTOR ASSEMBLY		SEATING TOOL	EXTRACTION TOOL
HEIGHT	CONFIGURATION		
Extended	2X1	62202-9915	62202-9960
Standard	2X1	62202-9910	62202-9930
Standard	2X2	62202-9970	62202-9975
Standard	2X4	62202-9920	62202-9940
Standard	2X5	62202-9980	62202-9990
Standard	2X6	62202-9925	62202-9950
Standard	2x8	62202-9810	62202-9820

*Figure 8*

REVISION: <b>G</b>	ECR/ECN INFORMATION: EC No: <b>UCP2011-3934</b> DATE: <b>2011 / 06 / 04</b>	TITLE: <b>Stacked SFP &amp; SFP+ Connectors</b>	SHEET No. <b>16 of 18</b>
DOCUMENT NUMBER: <b>AS-75310-001</b>	CREATED / REVISED BY: <b>Jlong/Jgonzalez</b>	CHECKED BY: <b>Jjantelezio</b>	APPROVED BY: <b>Mbanakis</b>



# APPLICATION SPECIFICATION

## 10.0 VISUAL AIDS

The illustration below shows the typical applications of the stacked SFP/SFP+ connector assemblies with elastomeric gasket and light pipes. The illustrations should be used by production personnel to ensure a correctly applied product. Applications, which DO NOT appear correct, should be inspected using the information in the preceding pages of this specification and in the instructional material shipped with the product or tooling. Refer to Figure 9a and Figure 9b.

### 2x1 Extended Height Connector Assemblies

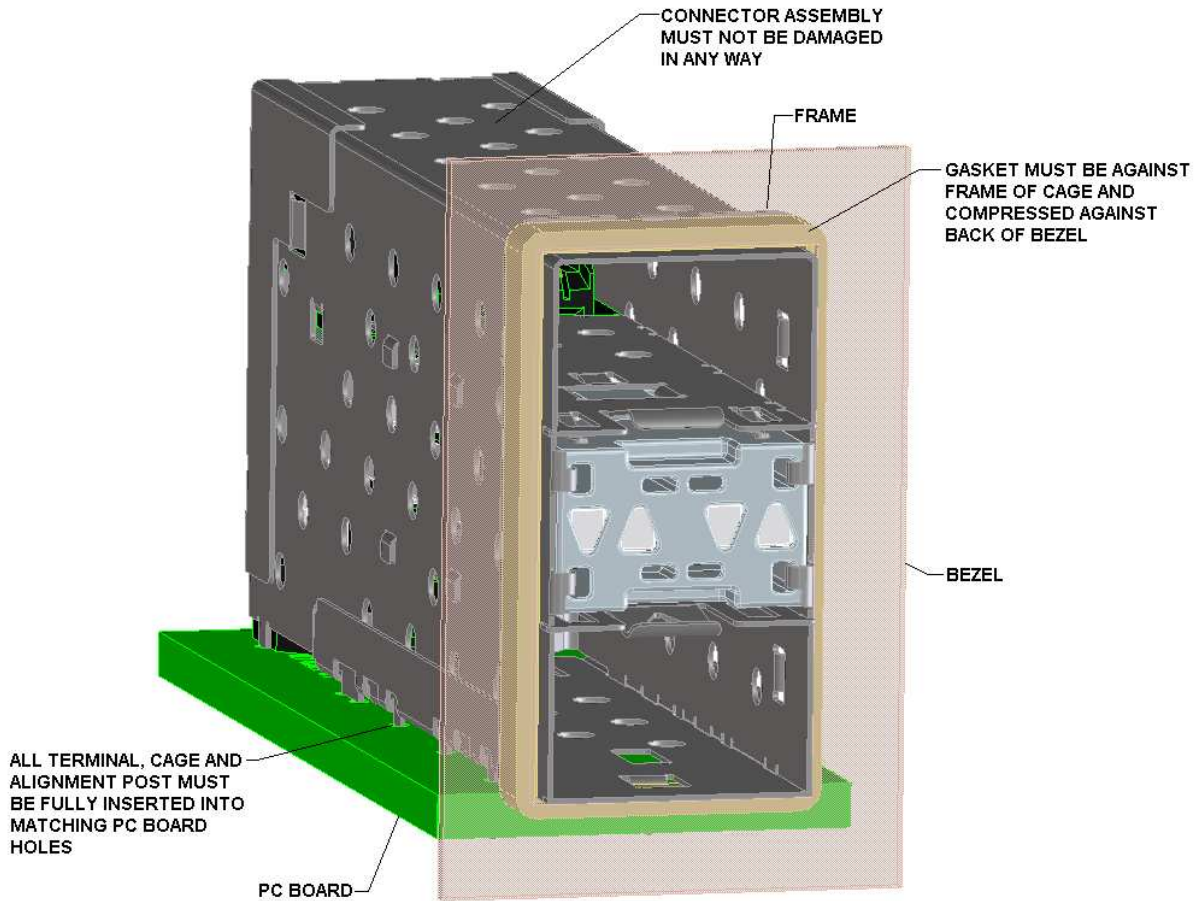

Figure 9a

REVISION: <b>G</b>	ECR/ECN INFORMATION: EC No: <b>UCP2011-3934</b> DATE: <b>2011 / 06 / 04</b>	TITLE: <b>Stacked SFP &amp; SFP+ Connectors</b>	SHEET No. <b>17 of 18</b>
DOCUMENT NUMBER: <b>AS-75310-001</b>	CREATED / REVISED BY: <b>Jlong/Jgonzalez</b>	CHECKED BY: <b>Jjantelezio</b>	APPROVED BY: <b>Mbanakis</b>





# APPLICATION SPECIFICATION

*2x2 Standard Height Connector Assembly with light pipes Configuration Shown*  
*Requirements Also Apply for all 2x1 thru 2x8 Configurations*

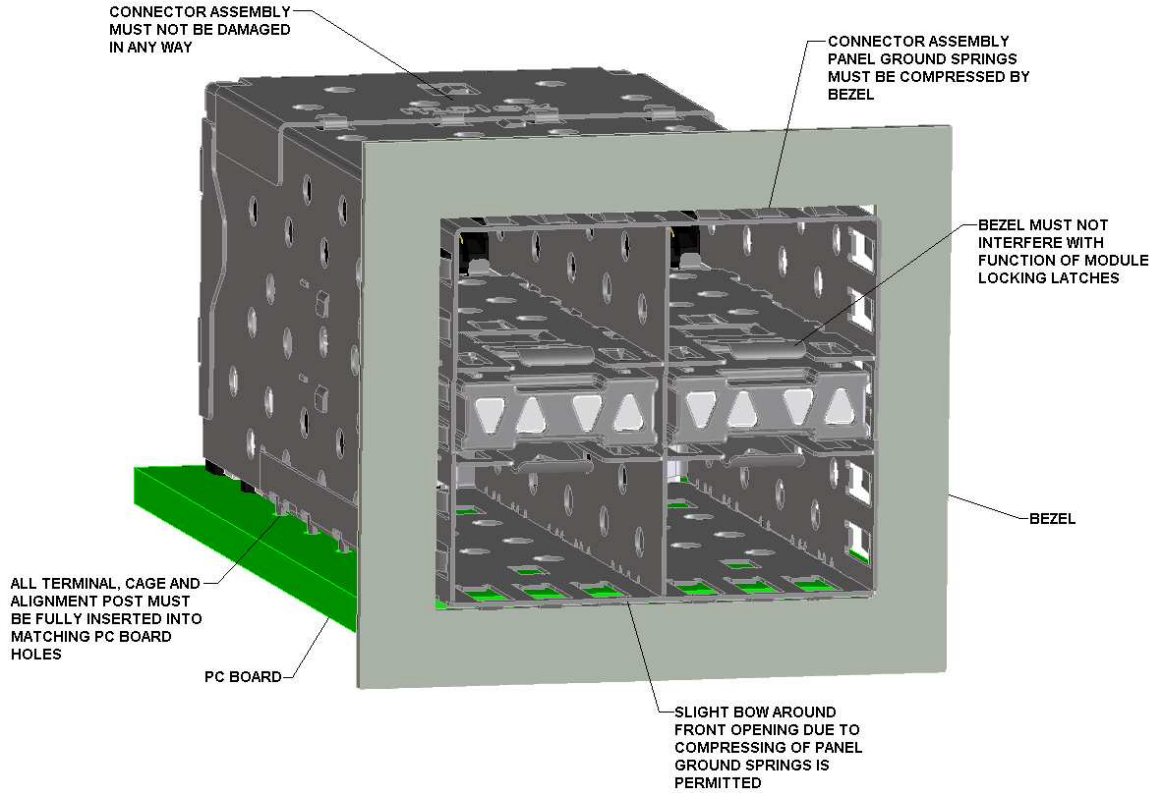

**Figure 9b**

REVISION: <b>G</b>	ECR/ECN INFORMATION: EC No: <b>UCP2011-3934</b> DATE: <b>2011 / 06 / 04</b>	TITLE: <b>Stacked SFP &amp; SFP+ Connectors</b>	SHEET No. <b>18 of 18</b>
DOCUMENT NUMBER: <b>AS-75310-001</b>	CREATED / REVISED BY: <b>Jlong/Jgonzalez</b>	CHECKED BY: <b>Jjantelezio</b>	APPROVED BY: <b>Mbanakis</b>