



Chipsmall Limited consists of a professional team with an average of over 10 year of expertise in the distribution of electronic components. Based in Hongkong, we have already established firm and mutual-benefit business relationships with customers from,Europe,America and south Asia,supplying obsolete and hard-to-find components to meet their specific needs.

With the principle of “Quality Parts,Customers Priority,Honest Operation,and Considerate Service”,our business mainly focus on the distribution of electronic components. Line cards we deal with include Microchip,ALPS,ROHM,Xilinx,Pulse,ON,Everlight and Freescale. Main products comprise IC,Modules,Potentiometer,IC Socket,Relay,Connector.Our parts cover such applications as commercial,industrial, and automotives areas.

We are looking forward to setting up business relationship with you and hope to provide you with the best service and solution. Let us make a better world for our industry!



Contact us

Tel: +86-755-8981 8866 Fax: +86-755-8427 6832

Email & Skype: info@chipsmall.com Web: www.chipsmall.com

Address: A1208, Overseas Decoration Building, #122 Zhenhua RD., Futian, Shenzhen, China



HSMP-3866

Quad PIN Diode Pi Attenuator 300 kHz to 3 GHz
in SOT 25 Package



Data Sheet



Description

Avago Technology's HSMP-3866 is a wideband, low insertion loss, low current, Quad PIN Diode Pi Attenuator in a low cost surface mount SOT-25 package. It provides a good match and flat attenuation over an extremely wide band from 300 kHz to 3 GHz.

The SOT-25 packages gives a reduction in part count and takes up less space on board compared to multi package solutions.

Four PIN Diodes in one package encourages performance repeatability for improved production yield at board level.

Package Marking and Pin connections

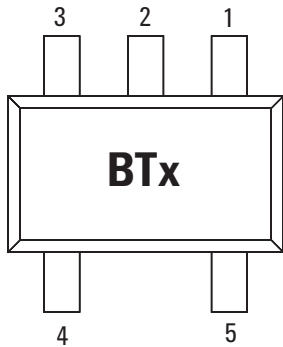

Note:
Package marking provides orientation and identification
"BT" = Device Code
"x" = Month code indicates the month of manufacture

Pin 3 : RF In/Out
Pin 2 : Series Bias
Pin 1 : RF In/Out

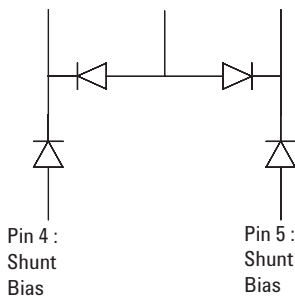

Features

- 4 PIN Diodes in a SOT-25 package
- 300 kHz to 3 GHz usable frequency band
- Low Current
- Low insertion Loss
- MSL-1 and Lead-free
- Tape & Reel packaging option available

Specification At 1 GHz, V+=1.2V

- IIP3 = 30 dBm (Typical)
- Attenuation = 36 dB (Typical)
- Insertion Loss = -2.5 dB (Typical)
- Return Loss = -18 dB (Typical)

Application

- Broadband system application (i.e., CATV, WCDMA, etc)
- General purpose Voltage-Control-Attenuator for low current applications.

Absolute Max Ratings ^[1], Tc = +25°C

Symbol	Parameter	Unit	Abs Max
I _f	Forward Current (1 μs Pulse)	Amp	1
P _{IV}	Peak Inverse Voltage	V	50
T _j	Junction Temperature	°C	150
T _{stg}	Storage Temperature	°C	-65 to 150
θ _{jb}	Thermal Resistance ^[2]	°C/W	167

Notes :

1. Operation in excess of any one of these conditions may result in permanent damage to the device.
2. Thermal Resistance is measured from junction to board using IR method.

Electrical Specifications, Tc = +25°C (Each Diode)

	Minimum Breakdown Voltage V _{BR} (V)	Typical Series Resistance R _S (Ω)	Typical Total Capacitance C _T (pF)
	50	3.0/1.5*	0.22
Test Condition	V _R = V _{BR} Measure I _R ≤ 10 μA	I _F = 10 mA, f = 100 MHz I _F = 100 mA*	V _R = 50 V f = 1 MHz

Typical Performance, Tc = +25°C (Each Diode)

	Total Resistance R _T (Ω)	Carrier Lifetime τ (ns)	Reverse Recovery Time T _{rr} (ns)	Total Capacitance C _T (pF)
	22	500	80	0.22
Test Condition	I _F = 1 mA f = 1 MHz	I _F = 10mA I _R = 250 mA	V _R = 50 V I _F = 10 mA 90% Recovery	V _R = 50V f = 1MHz

Typical Performance for HSMP-3866 Quad PIN Diode π Attenuator @ +25°C

Parameter	Test Condition	Units	Typical
Insertion Loss	V _c = 5V, V ₊ = 1.2V, Freq = 1 GHz	dB	-2.5
Return Loss	V _c = 0V, V ₊ = 1.2V, Freq = 1 GHz	dB	-18
Attenuation	V _c = 0V, V ₊ = 1.2V, Freq = 1 GHz	dB	36
IP3	V _c = 1.5V, V ₊ = 1.2V, Freq = 1 GHz	dBm	30
IP3	V _c = 5.0V, V ₊ = 1.2V, Freq = 1 GHz	dBm	40
IP3	V _c = 1.5V, V ₊ = 1.2V, Freq = 300 MHz	dBm	25
IP3	V _c = 5.0V, V ₊ = 1.2V, Freq = 300 MHz	dBm	37
IP3	V _c = 1.5V, V ₊ = 1.2V, Freq = 100 MHz	dBm	23
IP3	V _c = 5.0V, V ₊ = 1.2V, Freq = 100 MHz	dBm	35

Notes :

1. Measurement above obtained using Wideband RF circuit design shown in Figure 1 & 2

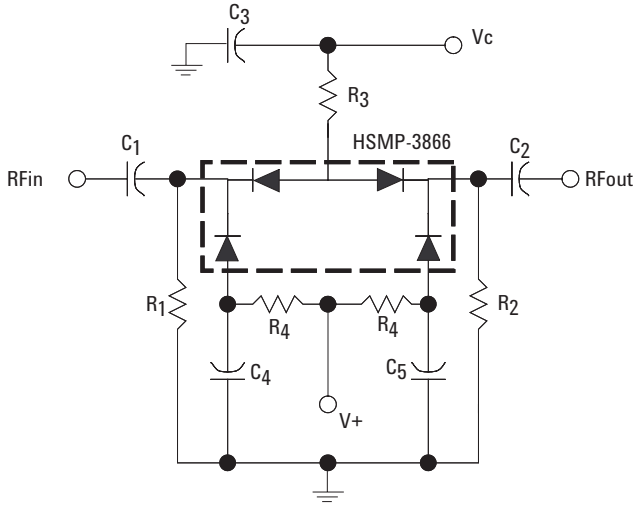

Component	Value
R1, R2	620 Ω
R3	390 Ω
R4	2200 Ω
C1 - C5	10 nF

Figure 1. Wideband Quad PIN Diode π Attenuator Circuit

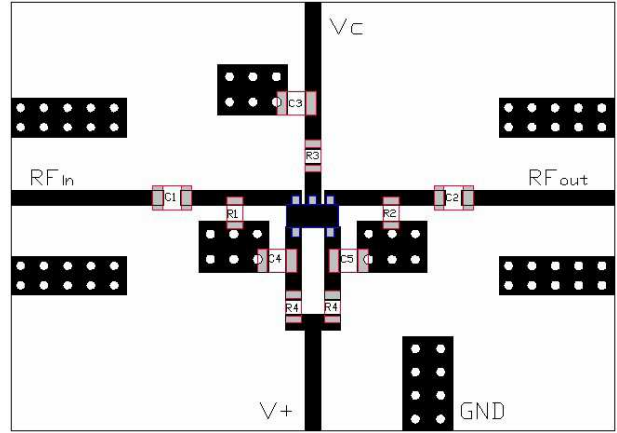

Figure 2. Circuit Board Layout.

Typical Performance Curves for Single Diode @ $T_c = +25^\circ\text{C}$

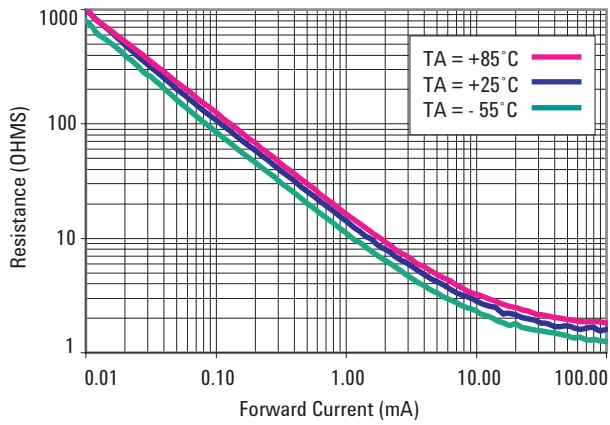

Figure 3. RF Resistance vs. Forward Bias Current

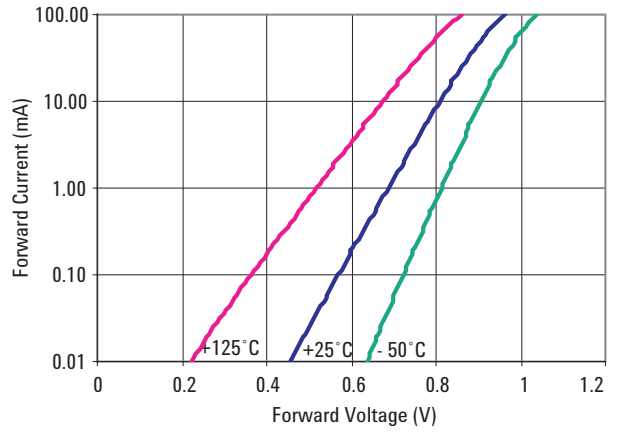

Figure 4. Forward Current vs. Forward Voltage

Typical Performance Curves for Single Diode @ $T_c = +25^\circ\text{C}$

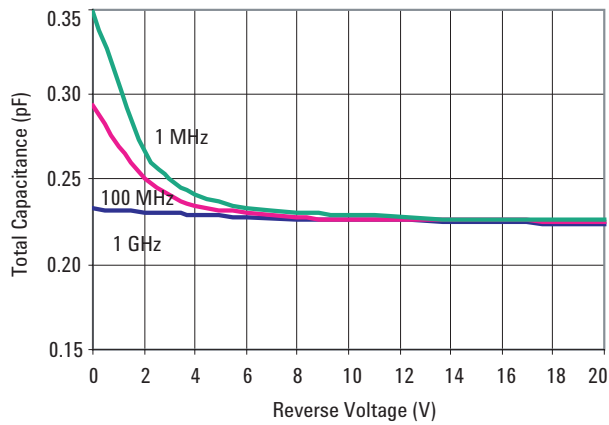

Figure 5. RF Capacitance vs Reverse Bias

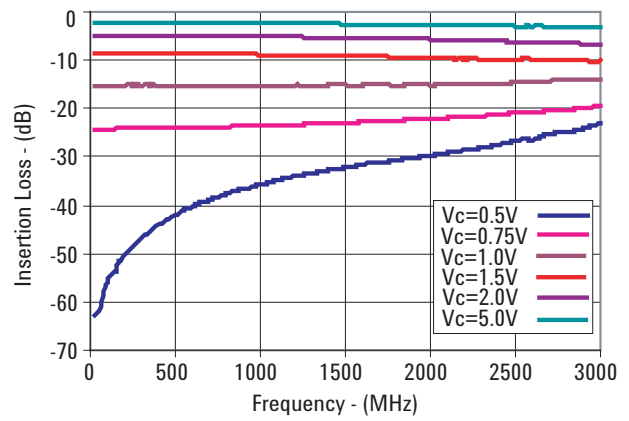

Figure 6. Insertion Loss vs. Frequency

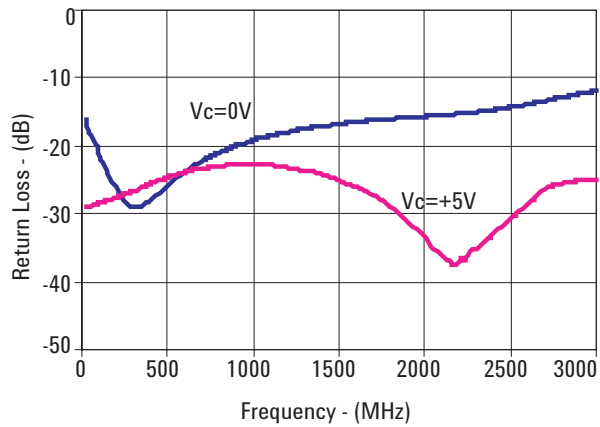

Figure 7. Return Loss vs. Frequency

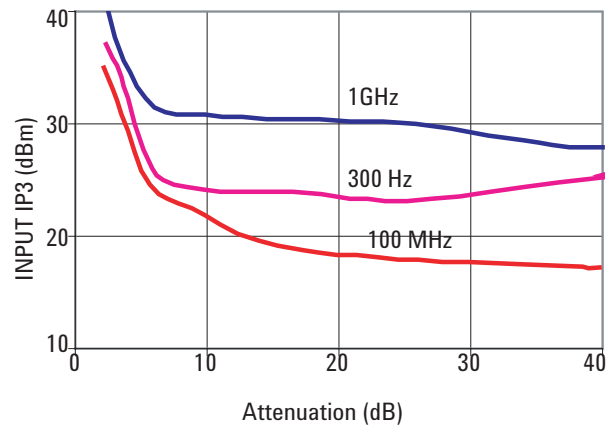

Figure 8. Input IP3 vs. Attenuation

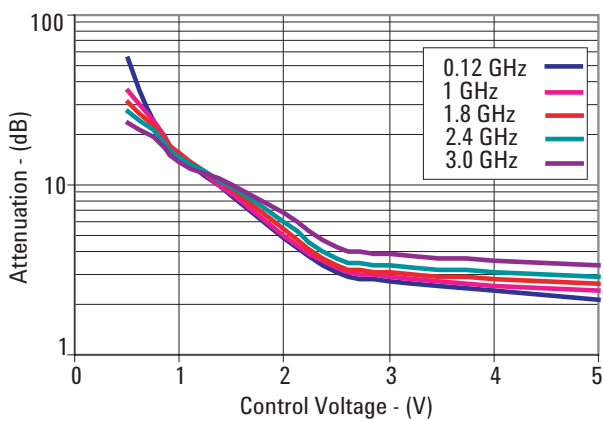
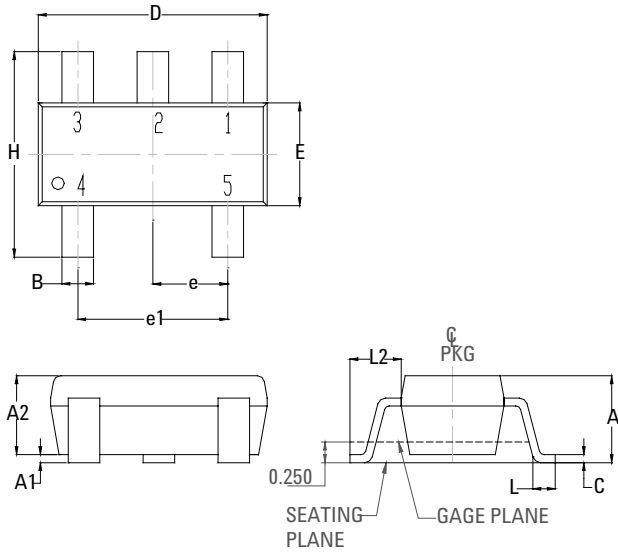

Figure 9. Attenuation vs. Control Voltage

Package Outline & Dimension



Symbol	Dimension		
	Minimum	Nominal	Maximum
D	2.80	2.90	3.00
H	2.60	2.80	3.00
E	1.50	1.60	1.70
e1	1.88	1.90	1.92
e	0.93	0.95	0.97
B	0.35		0.50
A2	0.9	1.15	1.30
C	0.08		0.22
L	0.35		0.60
A1	0		0.15
A	0.9		1.40

PCB Footprint

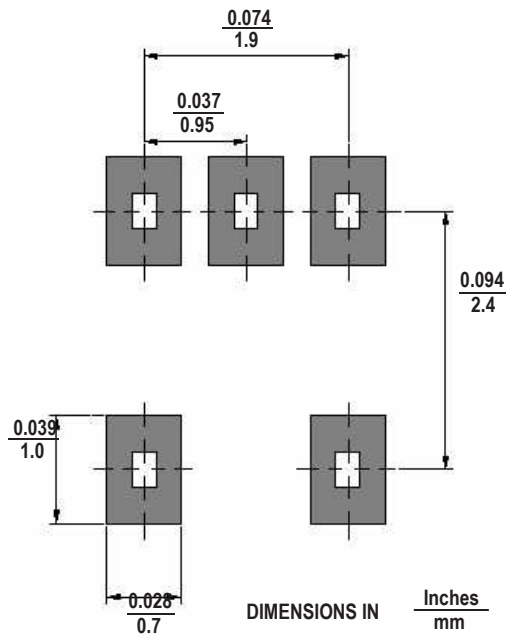

Device Orientation

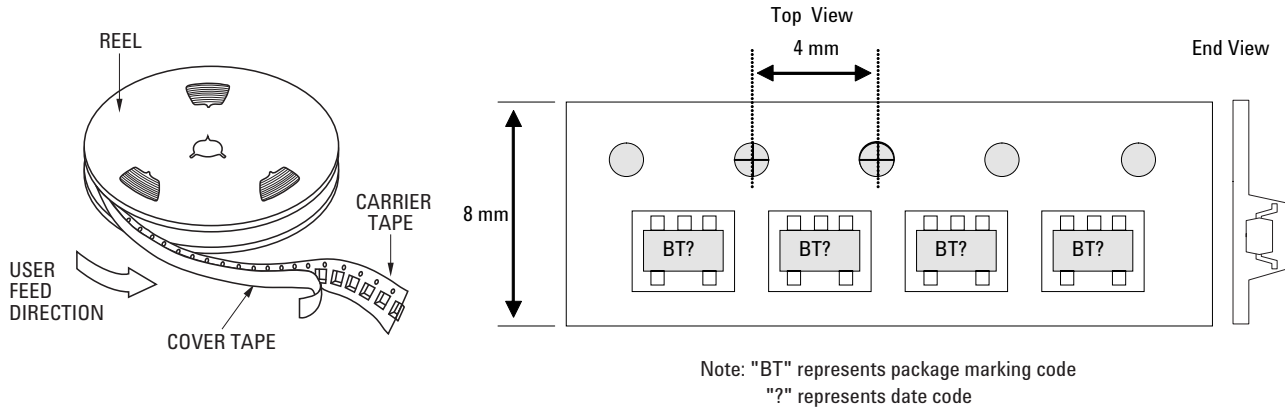

Tape Dimension

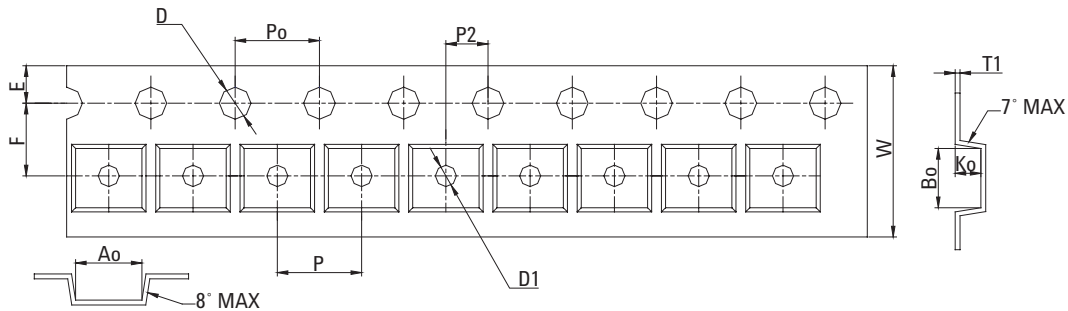

Symbol	Milmeters		
	Nominal	Minimum	Maximum
V	8.00 (0.315)	7.90 (0.311)	8.30 (0.327)
P	4.00 (0.157)	3.90 (0.154)	4.10 (0.161)
E	1.75 (0.069)	1.65 (0.065)	1.85 (0.073)
F	3.50 (0.138)	3.45 (0.136)	3.55 (0.140)
J	1.50 (0.059)	N/A	1.60 (0.063)
J1	1.00 (0.039)	N/A	1.25 (0.049)
Po	4.00 (0.157)	3.90 (0.154)	4.10 (0.161)
P2	2.00 (0.079)	1.95 (0.077)	2.05 (0.081)
Ao	3.23 (0.127)	3.13 (0.123)	3.33 (0.131)
Jo	3.81 (0.125)	3.08 (0.121)	3.28 (0.129)
Fo	1.60(0.063)	1.50 (0.059)	1.70 (0.067)
T1	0.254 (0.0100)	0.241 (0.0095)	0.267 (0.0105)

Part Number Ordering Information

Part number	No of Device	Container
HSMP-3866-BLKG	100	Anti-static bag
HSMP-3866-TR1G	3000	7" reel
HSMP-3866-TR2G	10000	13" reel

For product information and a complete list of distributors, please go to our web site: www.avagotech.com

Avago, Avago Technologies, and the A logo are trademarks of Avago Technologies in the United States and other countries. Data subject to change. Copyright © 2005-2009 Avago Technologies. All rights reserved. Obsoletes 5989-4497EN AV02-1962EN - June 3, 2009

AVAGO
TECHNOLOGIES