



Chipsmall Limited consists of a professional team with an average of over 10 year of expertise in the distribution of electronic components. Based in Hongkong, we have already established firm and mutual-benefit business relationships with customers from,Europe,America and south Asia,supplying obsolete and hard-to-find components to meet their specific needs.

With the principle of “Quality Parts,Customers Priority,Honest Operation,and Considerate Service”,our business mainly focus on the distribution of electronic components. Line cards we deal with include Microchip,ALPS,ROHM,Xilinx,Pulse,ON,Everlight and Freescale. Main products comprise IC,Modules,Potentiometer,IC Socket,Relay,Connector.Our parts cover such applications as commercial,industrial, and automotives areas.

We are looking forward to setting up business relationship with you and hope to provide you with the best service and solution. Let us make a better world for our industry!



## Contact us

Tel: +86-755-8981 8866 Fax: +86-755-8427 6832

Email & Skype: info@chipsmall.com Web: www.chipsmall.com

Address: A1208, Overseas Decoration Building, #122 Zhenhua RD., Futian, Shenzhen, China



# High Temperature Quad Operational Amplifier HT1104

The High Temperature Quad Operational Amplifier, HT1104, is a versatile performer over an extremely wide temperature range. It is fabricated with Honeywell's dielectrically isolated high-temperature linear (HTMOS™) process, and is designed specifically for use in systems operating in severe high temperature environments.



These amplifiers perform over the full -55°C to 225°C temperature range. All parts are burned in at 250°C. The HT1104 will operate with both single and split supplies. High temperature circuit applications such as transducer interfacing, amplification, active filtering, and signal buffering are all possible with the HT1104.

## APPLICATIONS:

- Down-Hole Oil Well
- Turbine Engine Control
- Avionics
- Industrial Process Control
- Electric Power Conversion
- Heavy Duty Internal Combustion Engine

## PINOUT DIAGRAM

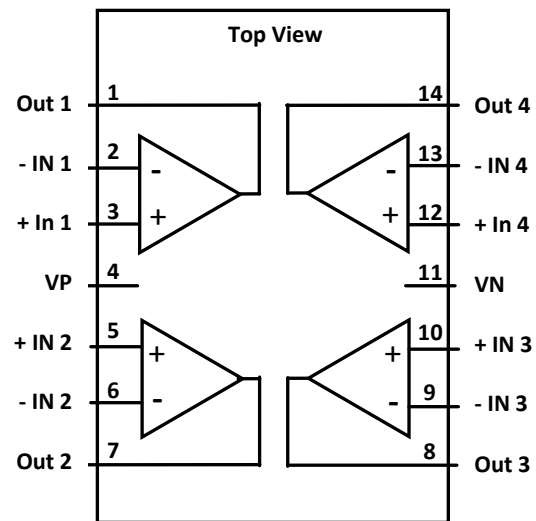

## FEATURES

- ▶ Specified Over -55°C to +225°C
- ▶ Single or Split Supply Operation
- ▶ Low Input Bias and Offset Parameters
- ▶ ESD Protection Circuitry
- ▶ Latch-up Free Design with Dielectric Isolation
- ▶ Hermetic 14-Lead Ceramic DIP package

**ABSOLUTE MAXIMUM RATINGS (1)**

Symbol	Parameter	Rating		Units
		Min	Max	
VN to VP	Total Supply Voltage		13	V
VPIN	Voltage on Any Pin (excluding power pins)	VN - 0.5	VP + 0.5	V
IOUT	DC or Average Output Current (each output)	-50	+50	mA
IOS	Output Short Circuit Current (1 second)		110	mA
VHBM	ESD Input Protection Voltage (Human Body Model)		2000	V
ΘJC	Thermal Resistance (Jct-to-Case)		10	°C/W
TSTORE	Storage Temperature	-65	300	°C
TSOLDER	Lead Temperature (soldering, 10 seconds)		355	°C
TJ	Junction Temperature		315	°C

(1) Stresses in excess of those listed above may result in permanent damage. These are stress ratings only, and operation at these levels is not implied. Frequent or extended exposure to absolute maximum conditions may affect device reliability.

**RECOMMENDED OPERATING CONDITIONS**

Symbol	Parameter	Min	Max	Units
VP	Positive Supply Voltage (Single supply)	5	10	V
VN	Negative Supply Voltage (Single supply)	0		V
VP	Positive Supply Voltage (Split supply)		+5	V
VN	Negative Supply Voltage (Split supply)	-5		V
IOUT	Continuous Output Current	-10	+10	mA
VPIN	Voltage on Any Pin (excluding power pins)	VN - 0.3	VP + 0.3	V
TC	Case Temperature	-55	225	°C

**ELECTRICAL SPECIFICATIONS**

Unless otherwise specified, specifications apply over the Recommended Operating Conditions.

VP = +5V, VN = -5V.

Symbol	Parameter	Conditions	Limits		Unit
			Min	Max	
IP	Supply Current			12.5	mA
VO	Output Voltage Swing	R = 10kΩ, C = 20pF	-4.8	+4.6	V
ISOH	Output Short Circuit Current High	Open Loop, VP > VN, Vo = 0V, Absolute value		110	mA
ISOL	Output Short Circuit Current Low	Open Loop, VN > VP, Vo = 0V, Absolute value		110	mA
ISOURCE	Output Drive Current - source	Open Loop, VP > VN, Vo = 0V, absolute value	10		mA
ISINK	Output Drive Current - sink	Open Loop, VN > VP, Vo = 0V, absolute value	10		mA
IIO	Input Offset Current	-55°C to 25°C	-10	10	nA
		+225°C	-50	50	nA
IB	Input Bias Current	-55°C to 25°C	-10	10	nA
		+225°C	-50	50	nA
VIO	Input Offset Voltage		-7	7	mV

Symbol	Parameter	Conditions	Limits		Unit
			Min	Max	
V <sub>CM</sub>	Input Common Mode Voltage Range	25°C to +225°C, -55°C	VN+0.2	VP-2.2	V
			VN+0.2	VP-2.4	V
A <sub>VOL</sub>	DC Open Loop Gain		100		dB
CMRR	Common Mode Rejection Ratio		80		dB
PSRR	Power Supply Rejection Ratio		66		dB

## TYPICAL ELECTRICAL SPECIFICATIONS

The following specifications are not tested on each device and are for reference only.

Symbol	Parameter	Conditions	Typical	Units
V <sub>IO</sub>	Input Offset Voltage	Drift with Temperature	10	μV/°C
N	Noise	f <sub>o</sub> = 10 Hz	200	nv/√Hz
		f <sub>o</sub> = 1 kHz	30	nv/√Hz
		f = 0.1 to 10 Hz	8	μV, p-p
SR	Slew Rate	R = 10kΩ, C = 20pF, 25°C	1.4	V/μsec
UGB	Unity Gain Bandwidth	R = 10kΩ, C = 20pF, 25°C	1.4	MHz
∅M	Phase Margin	C = 20pF	60	degrees
AM	Gain Margin	C = 20pF	8	dB

## SIMPLIFIED SCHEMATIC (each amplifier)

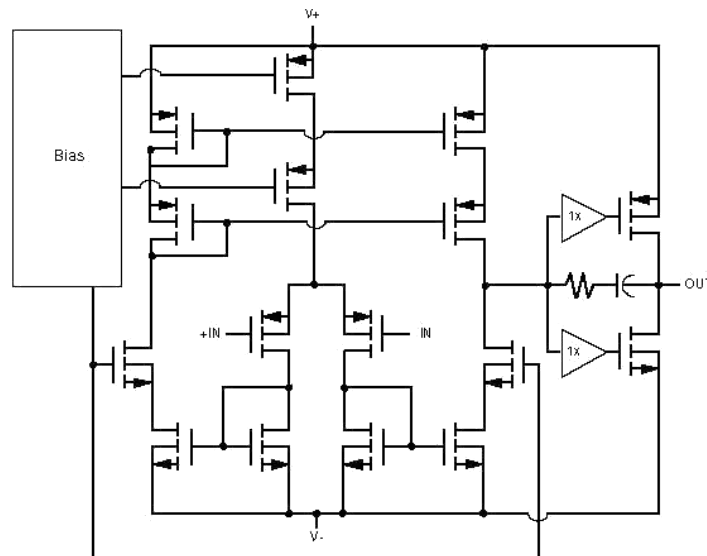

PACKAGE DETAIL

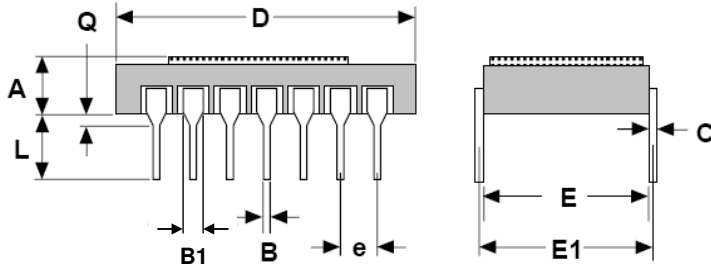

<b>A</b>	0.150 (max)	<b>E1</b>	0.300 ± 0.010
<b>B</b>	0.018 ± 0.002	<b>B1</b>	0.047 ± 0.002
<b>C</b>	0.010 ± 0.002	<b>e</b>	0.100 ± 0.005
<b>D</b>	0.700 ± 0.010	<b>L</b>	0.125 to 0.180
<b>E</b>	0.295 REF	<b>Q</b>	0.035 ± 0.010

All dimensions in inches  
Leads are Gold Plated Nickel

TYPICAL PERFORMANCE PLOTS

SUPPLY CURRENT vs. TEMPERATURE

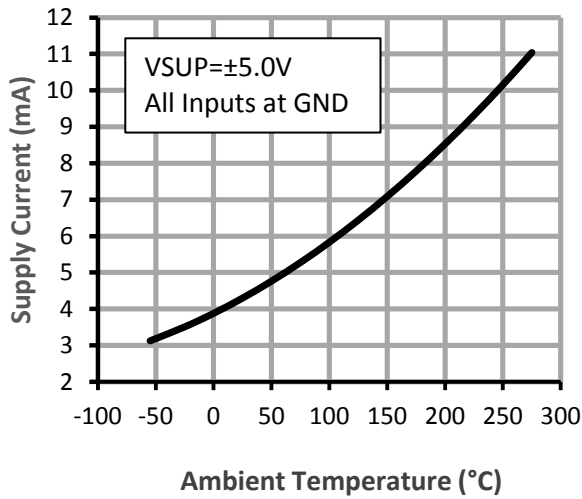

SLEW RATE vs. TEMPERATURE

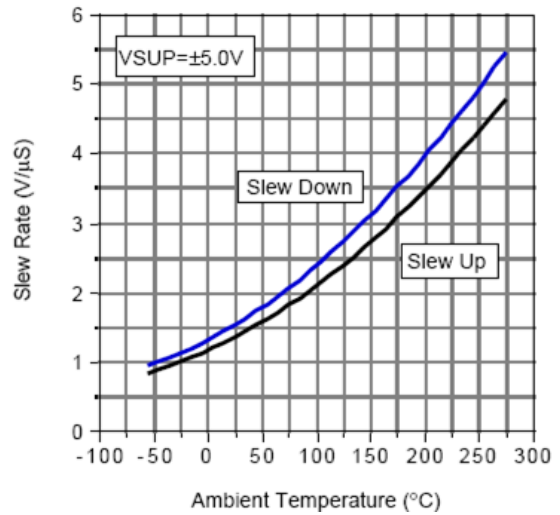

**OPEN LOOP GAIN and PHASE vs. FREQUENCY**

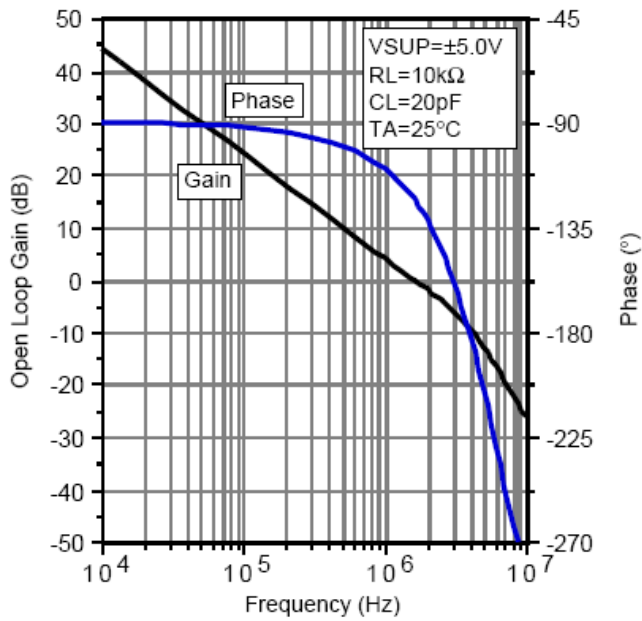

**OPEN LOOP GAIN and PHASE vs. FREQUENCY**

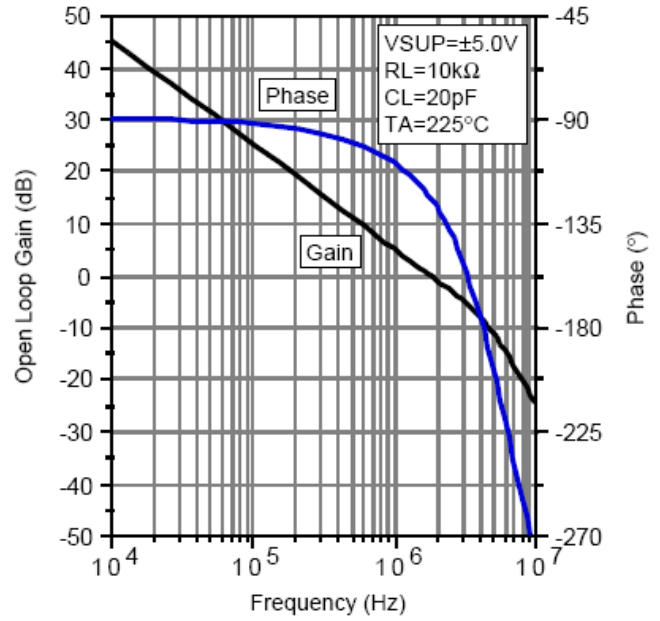

**OPEN LOOP GAIN and PHASE vs. FREQUENCY**

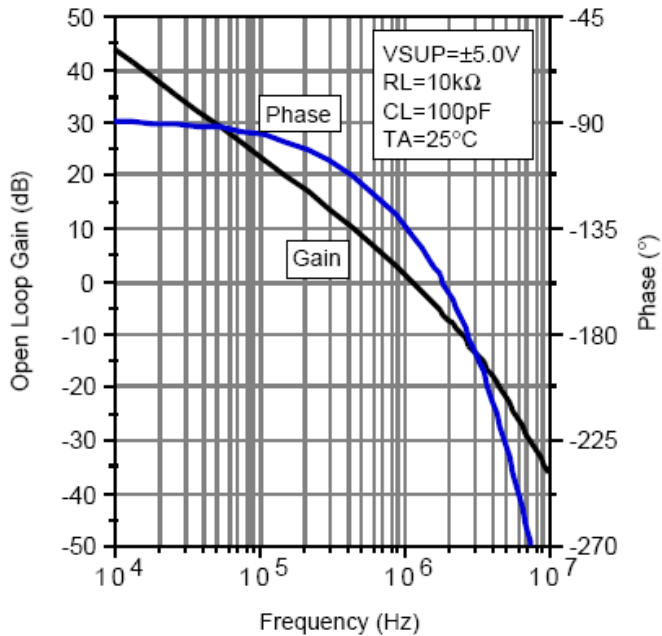

**OPEN LOOP GAIN and PHASE vs. FREQUENCY**

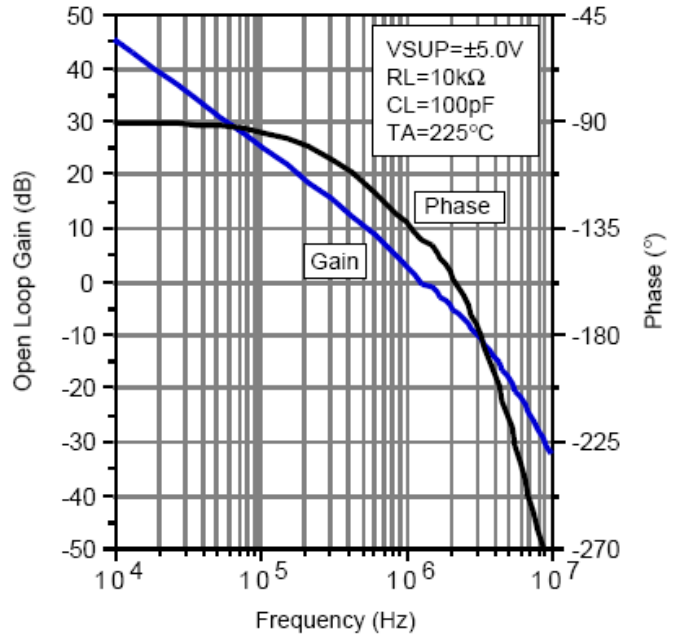

**OPEN LOOP GAIN and PHASE vs. FREQUENCY**

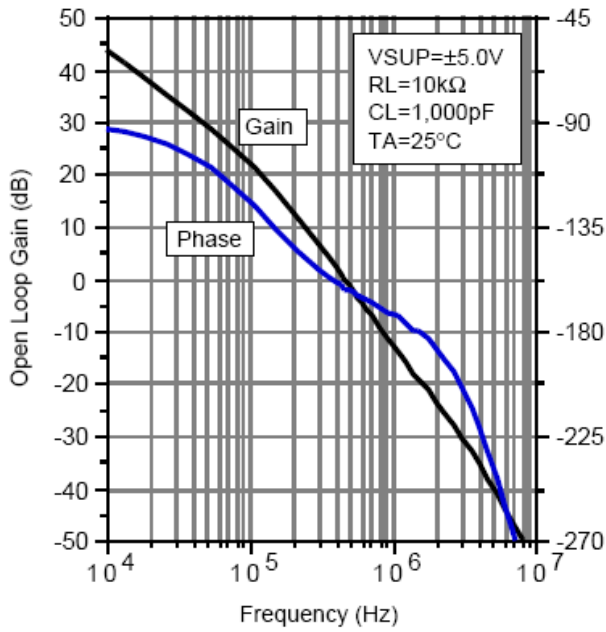

**OPEN LOOP GAIN and PHASE vs. FREQUENCY**

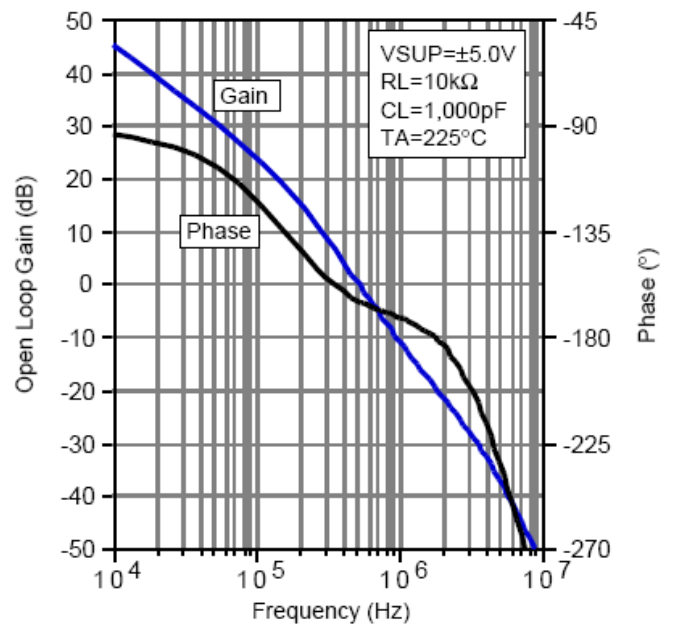

**COMMON MODE REJECTION RATIO vs. FREQUENCY**

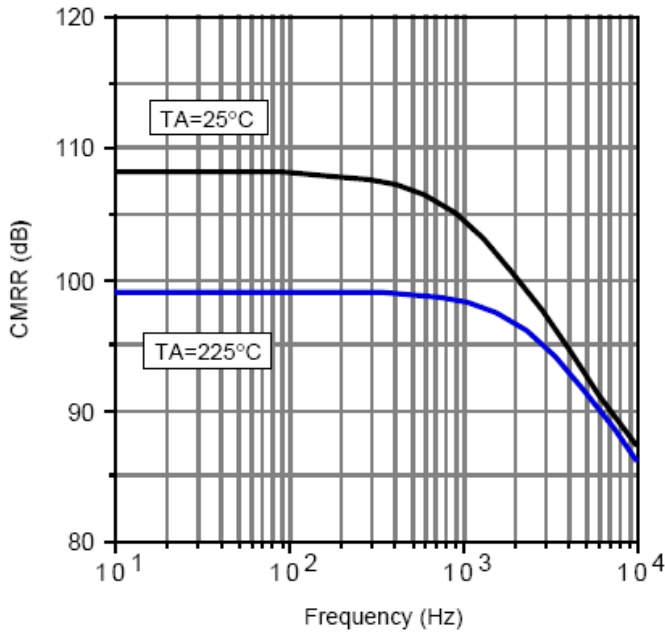

**OPEN LOOP GAIN vs. FREQUENCY**

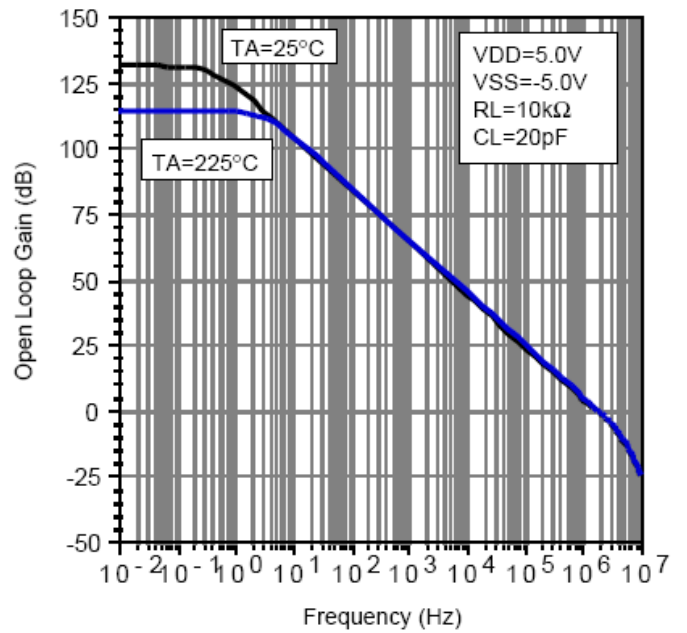

**MAXIMUM OUTPUT SWING vs. LOAD CURRENT**

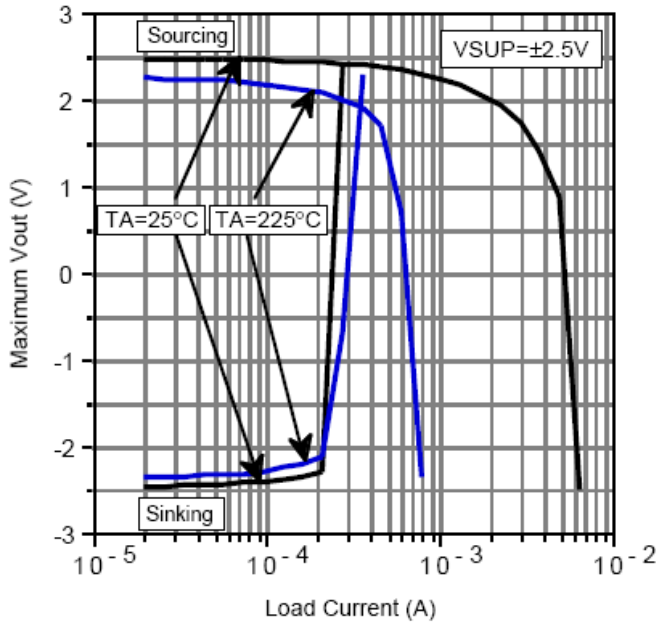

**MAXIMUM OUTPUT SWING vs. LOAD CURRENT**

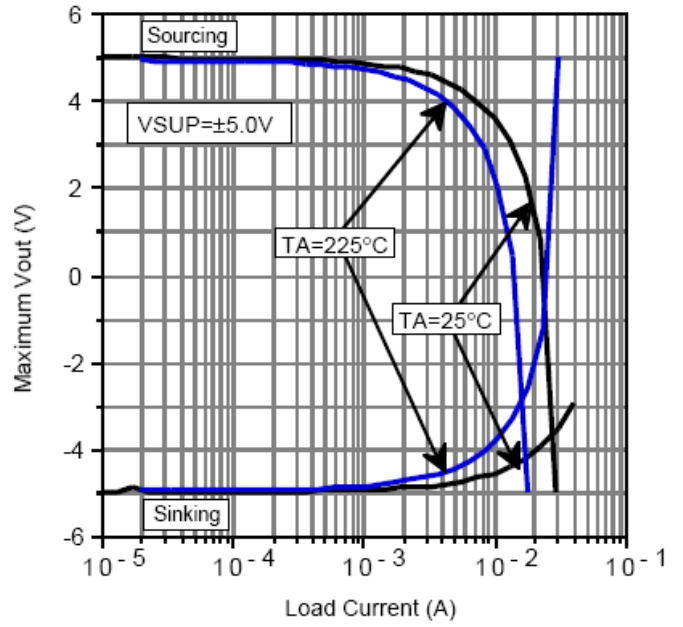

**POSITIVE POWER SUPPLY REJECTION vs. FREQUENCY**

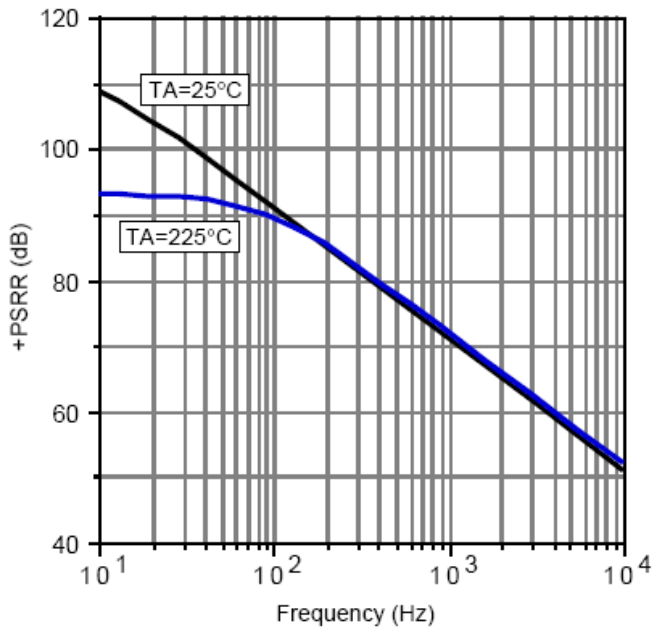

**NEGATIVE POWER SUPPLY REJECTION vs. FREQUENCY**

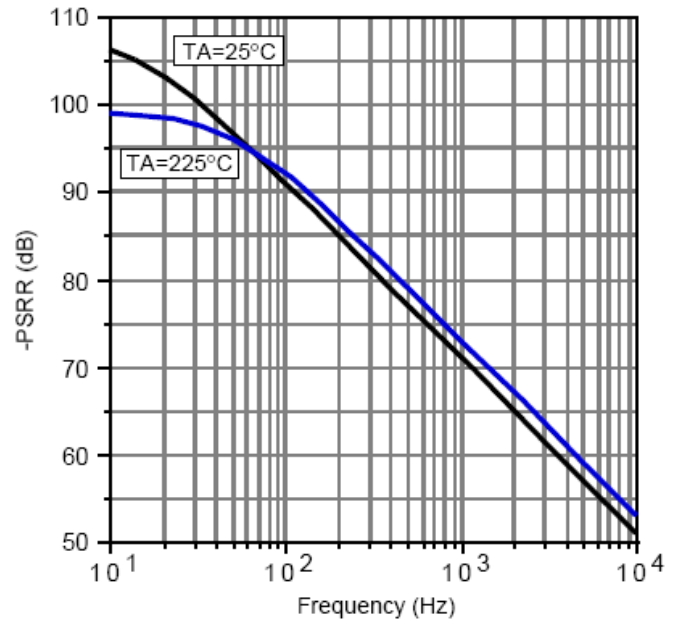



**UPPER COMMON MODE LIMIT vs. TEMPERATURE**

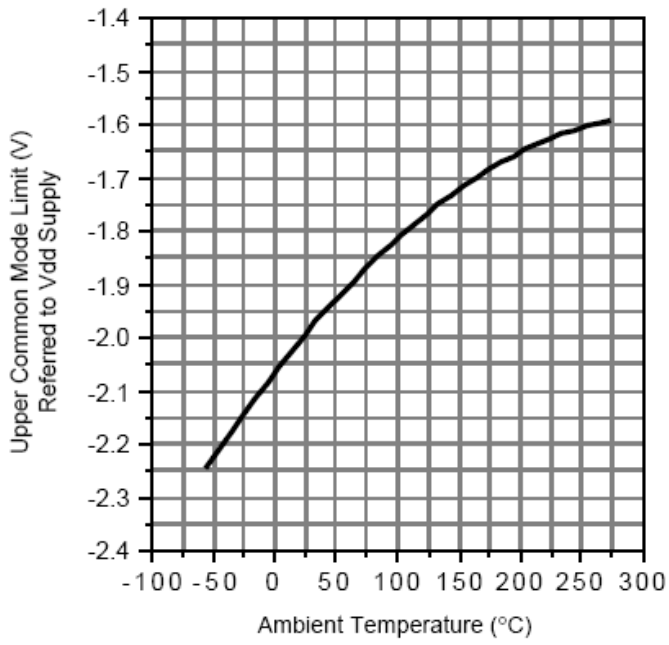

**INPUT REFERRED NOISE VOLTAGE vs. FREQUENCY**

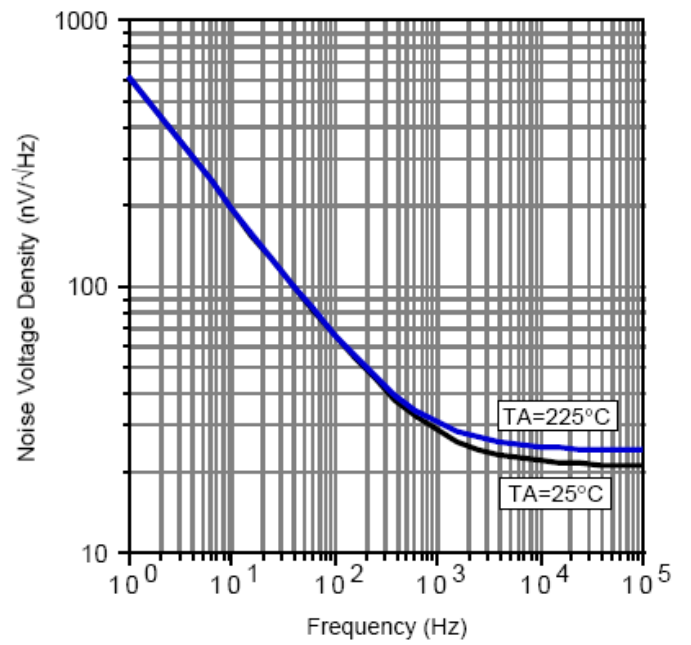

Small Signal Step Response

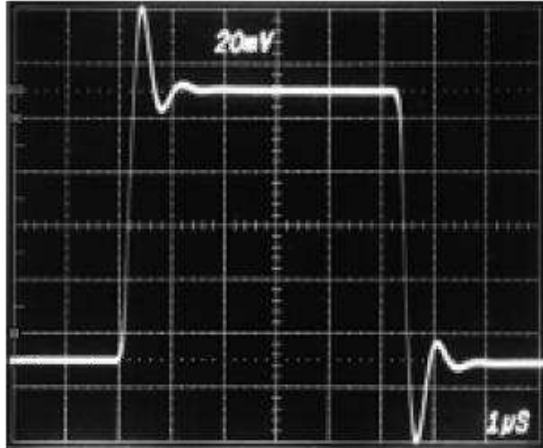

TA=225°C, CL=100pF  
Small Signal Step Response

Large Signal Step Response

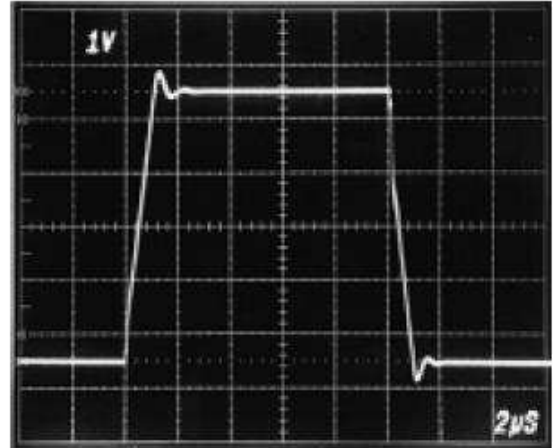

TA=225°C, CL=100pF  
Large Signal Step Response

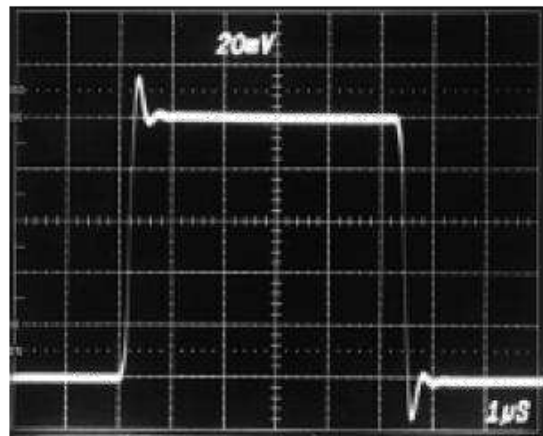

TA=225°C, CL=20pF  
**SMALL SIGNAL PULSE RESPONSE**

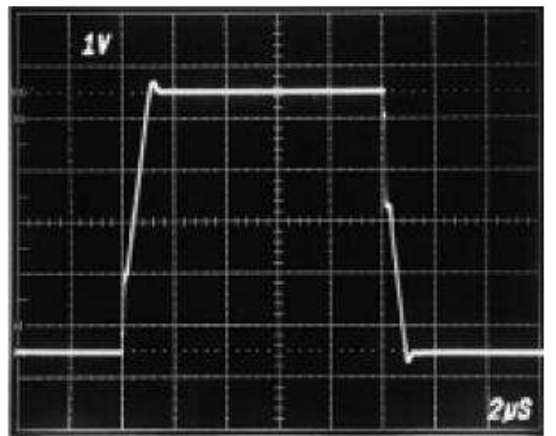

TA=225°C, CL=20pF  
**SMALL SIGNAL PULSE RESPONSE**

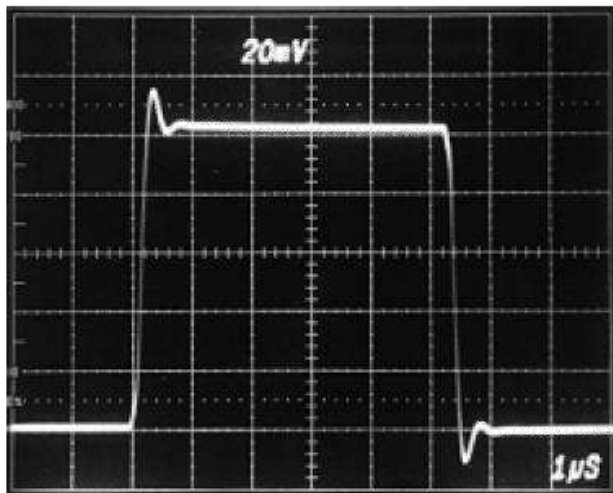

TA=25°C, CL=20pF, Av=+1

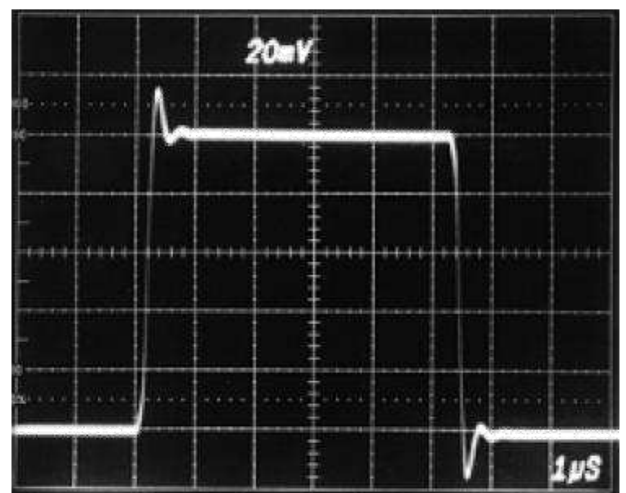

TA=225°C, CL=20pF, Av=+1

Small Signal Step Response

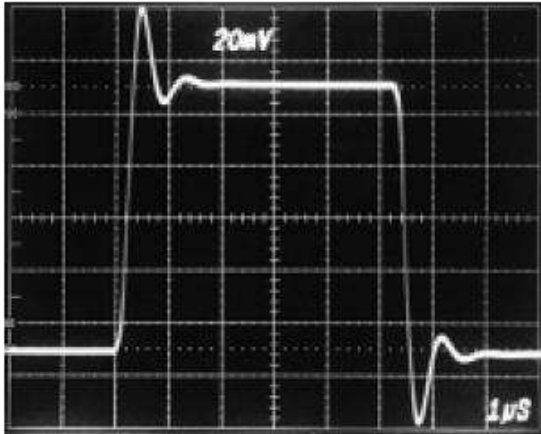

TA=25°C, CL=100pF

Large Signal Step Response

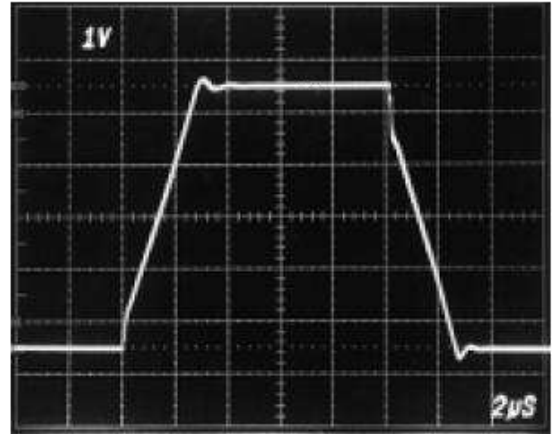

TA=25°C, CL=100pF

**ORDERING INFORMATION**

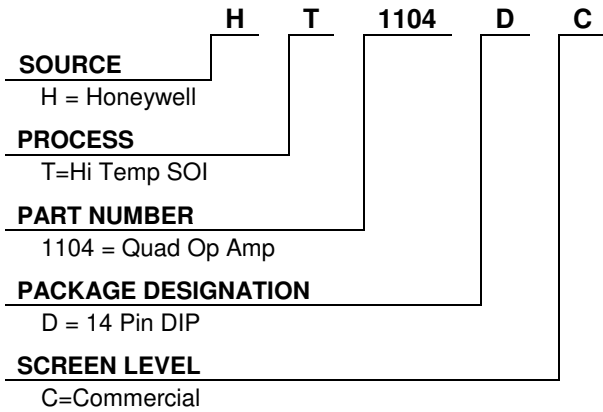

**Find out more**

For more information on Honeywell's High Temperature Electronics visit us online at [www.hightempsolutions.com](http://www.hightempsolutions.com), or contact us at 1-800-323-8295. Customer Service Email: [ps.customer.support@honeywell.com](mailto:ps.customer.support@honeywell.com).

Honeywell reserves the right to make changes of any sort without notice to any and all products, technology and testing identified herein. You are advised to consult Honeywell or an authorized sales representative to verify that the information in this data sheet is current before ordering this product. Absent express contract terms to the contrary, Honeywell does not assume any liability of any sort arising out of the application or use of any product or circuit described herein; nor does it convey any license or other intellectual property rights of Honeywell or of third parties.