



Chipsmall Limited consists of a professional team with an average of over 10 year of expertise in the distribution of electronic components. Based in Hongkong, we have already established firm and mutual-benefit business relationships with customers from,Europe,America and south Asia,supplying obsolete and hard-to-find components to meet their specific needs.

With the principle of "Quality Parts,Customers Priority,Honest Operation,and Considerate Service",our business mainly focus on the distribution of electronic components. Line cards we deal with include Microchip,ALPS,ROHM,Xilinx,Pulse,ON,Everlight and Freescale. Main products comprise IC,Modules,Potentiometer,IC Socket,Relay,Connector.Our parts cover such applications as commercial,industrial, and automotives areas.

We are looking forward to setting up business relationship with you and hope to provide you with the best service and solution. Let us make a better world for our industry!



Contact us

Tel: +86-755-8981 8866 Fax: +86-755-8427 6832

Email & Skype: info@chipsmall.com Web: www.chipsmall.com

Address: A1208, Overseas Decoration Building, #122 Zhenhua RD., Futian, Shenzhen, China





HTB18-B4A2AB

SureSense

CYLINDRICAL PHOTOELECTRIC SENSORS

SICK
Sensor Intelligence.



Illustration may differ



Ordering information

Type	Part no.
HTB18-B4A2AB	1070989

Other models and accessories → www.sick.com/SureSense

Detailed technical data

Features

Sensor/ detection principle	Photoelectric proximity sensor, Background suppression
Dimensions (W x H x D)	16.2 mm x 48.5 mm x 31.8 mm
Housing design (light emission)	Hybrid
Thread diameter (housing)	M18
Sensing range max.	5 mm ... 300 mm ¹⁾
Sensing range	5 mm ... 150 mm ²⁾
Type of light	Visible red light
Light source	PinPoint LED ³⁾
Light spot size (distance)	Ø 7 mm (300 mm)
Wave length	631 nm
Adjustment	Potentiometer (Sensing range)

¹⁾ Object with 90 % reflectance (referred to standard white, DIN 5033).

²⁾ Object with 6 % reflectance (referred to standard black, DIN 5033).

³⁾ Average service life: 100,000 h at T_J = +25 °C.

Mechanics/electronics

Supply voltage	10 V DC ... 30 V DC ^{1) 2)}
Ripple	< 5 V _{pp} ³⁾
Power consumption	20 mA ⁴⁾
Switching output	PNP, NPN ⁵⁾
Switching mode	Light switching ⁵⁾
Output current I_{max.}	≤ 100 mA
Response time	≤ 0.5 ms ⁶⁾
Switching frequency	1,000 Hz ⁷⁾
Connection type	Male connector M12, 4-pin
Circuit protection	A ⁸⁾ B ⁹⁾ D ¹⁰⁾
Protection class	III ¹¹⁾
Weight	18 g
Housing material	Plastic, VISTAL®
Optics material	Plastic, PMMA
Enclosure rating	IP67 IP69K
Ambient operating temperature	-40 °C ... +65 °C
Ambient storage temperature	-40 °C ... +75 °C
UL File No.	E189383

¹⁾ Above T_a 55 °C, max. voltage = 24 V and max. current = 50 mA.

²⁾ Limit values when operated in short-circuit protected network: max. 8 A.

³⁾ May not exceed or fall below U_v tolerances.

⁴⁾ Without signal strength light bar and load.

⁵⁾ Q1 = PNP; Q2 = NPN.

⁶⁾ Signal transit time with resistive load.

⁷⁾ With light/dark ratio 1:1.

⁸⁾ A = V_S connections reverse-polarity protected.

⁹⁾ B = inputs and output reverse-polarity protected.

¹⁰⁾ D = outputs overcurrent and short-circuit protected.

¹¹⁾ Reference voltage: 50 V DC.

Classifications

ECl@ss 5.0	27270904
ECl@ss 5.1.4	27270904
ECl@ss 6.0	27270904
ECl@ss 6.2	27270904
ECl@ss 7.0	27270904
ECl@ss 8.0	27270904
ECl@ss 8.1	27270904
ECl@ss 9.0	27270904
ETIM 5.0	EC002719

ETIM 6.0	EC002719
UNSPSC 16.0901	39121528

Connection diagram

Cd-243

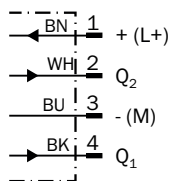

Characteristic curve

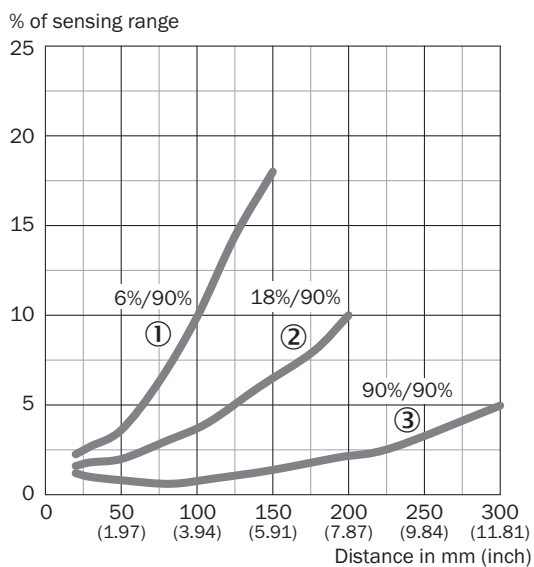

- ① Sensing range on black, 6% remission
- ② Sensing range on gray, 18% remission
- ③ Sensing range on white, 90% remission

Light spot size

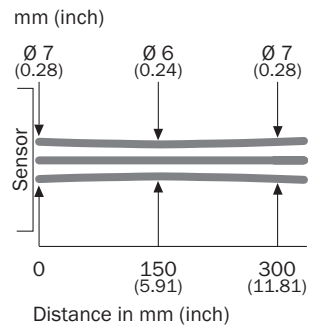

Sensing range diagram

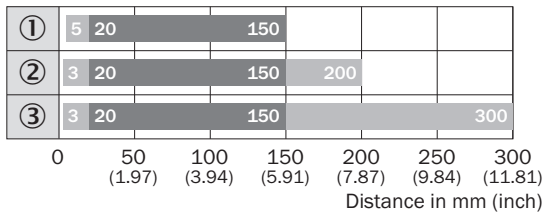

■ Sensing range ■ Sensing range max.

- ① Sensing range on black, 6% remission
- ② Sensing range on gray, 18 % remission
- ③ Sensing range on white, 90% remission

Dimensional drawing (Dimensions in mm (inch))



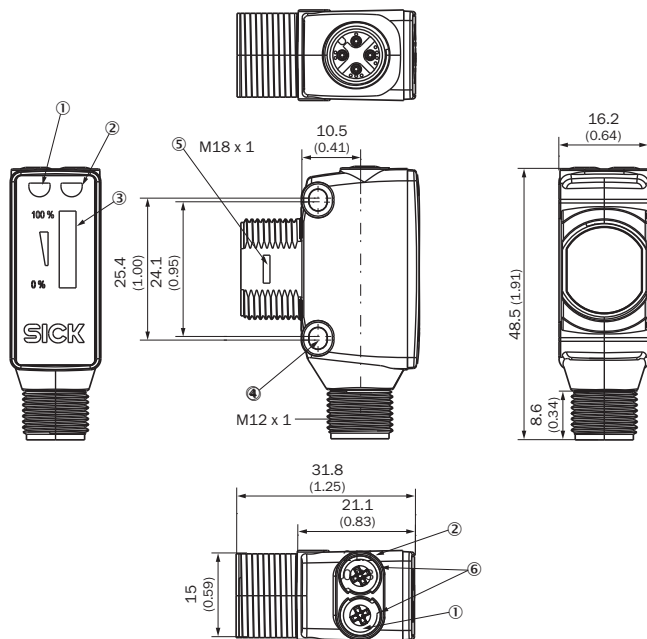

H18, DC, male connector M12



- ① LED indicator green: power on
- ② LED indicator yellow: Status of received light beam
- ③ Signal strength light bar
- ④ M3 mounting hole
- ⑤ Snap Connection for flush ring (sold separately)
- ⑥ Potentiometer (if selected) or LED Indicators

Recommended accessories

Other models and accessories → www.sick.com/SureSense

	Brief description	Type	Part no.
Mounting brackets and plates			
	Mounting plate for M18 sensors, steel, zinc coated, without mounting hardware	BEF-WG-M18	5321870
	Mounting bracket for M18 sensors, steel, zinc coated, without mounting hardware	BEF-WN-M18	5308446
	Bottom M18 mounting bracket SureSense sensors	MB-M18-H18	2085820
Other mounting accessories			
	Spherical bearing M18	Ball holder	4057409
	Mounting bracket	MB-BS18MM-M4	2049694
Terminal and alignment brackets			
	Clamping block for round sensors M18, without fixed stop, plastic (PA12), glass-fiber reinforced, mounting hardware included	BEF-KH-M18	2051481
Plug connectors and cables			
	Head A: female connector, M12, 4-pin, straight Head B: Flying leads Cable: PVC, unshielded, 2 m	DOL-1204-G02M	6009382
	Head A: female connector, M12, 4-pin, straight Head B: Flying leads Cable: PVC, unshielded, 5 m	DOL-1204-G05M	6009866
	Head A: female connector, M12, 4-pin, angled Head B: Flying leads Cable: PVC, unshielded, 2 m	DOL-1204-W02M	6009383
	Head A: female connector, M12, 4-pin, angled Head B: Flying leads Cable: PVC, unshielded, 5 m	DOL-1204-W05M	6009867

SICK AT A GLANCE

SICK is one of the leading manufacturers of intelligent sensors and sensor solutions for industrial applications. A unique range of products and services creates the perfect basis for controlling processes securely and efficiently, protecting individuals from accidents and preventing damage to the environment.

We have extensive experience in a wide range of industries and understand their processes and requirements. With intelligent sensors, we can deliver exactly what our customers need. In application centers in Europe, Asia and North America, system solutions are tested and optimized in accordance with customer specifications. All this makes us a reliable supplier and development partner.

Comprehensive services complete our offering: SICK LifeTime Services provide support throughout the machine life cycle and ensure safety and productivity.

For us, that is “Sensor Intelligence.”

WORLDWIDE PRESENCE:

Contacts and other locations www.sick.com