



Chipsmall Limited consists of a professional team with an average of over 10 year of expertise in the distribution of electronic components. Based in Hongkong, we have already established firm and mutual-benefit business relationships with customers from,Europe,America and south Asia,supplying obsolete and hard-to-find components to meet their specific needs.

With the principle of "Quality Parts,Customers Priority,Honest Operation,and Considerate Service",our business mainly focus on the distribution of electronic components. Line cards we deal with include Microchip,ALPS,ROHM,Xilinx,Pulse,ON,Everlight and Freescale. Main products comprise IC,Modules,Potentiometer,IC Socket,Relay,Connector.Our parts cover such applications as commercial,industrial, and automotives areas.

We are looking forward to setting up business relationship with you and hope to provide you with the best service and solution. Let us make a better world for our industry!



## Contact us

Tel: +86-755-8981 8866 Fax: +86-755-8427 6832

Email & Skype: info@chipsmall.com Web: www.chipsmall.com

Address: A1208, Overseas Decoration Building, #122 Zhenhua RD., Futian, Shenzhen, China





# HTF18L-P4A5BB

SureSense

CYLINDRICAL PHOTOELECTRIC SENSORS

**SICK**  
Sensor Intelligence.



Illustration may differ



## Ordering information

Type	Part no.
HTF18L-P4A5BB	1075810

Other models and accessories → [www.sick.com/SureSense](http://www.sick.com/SureSense)

## Detailed technical data

### Features

<b>Sensor/ detection principle</b>	Photoelectric proximity sensor, Foreground suppression
<b>Dimensions (W x H x D)</b>	16.2 mm x 48.5 mm x 31.8 mm
<b>Housing design (light emission)</b>	Hybrid
<b>Thread diameter (housing)</b>	M18
<b>Sensing range max.</b>	40 mm ... 300 mm <sup>1)</sup>
<b>Sensing range</b>	40 mm ... 200 mm <sup>2)</sup>
<b>Type of light</b>	Visible red light
<b>Light source</b>	Laser <sup>3) 4)</sup>
<b>Light spot size (distance)</b>	Ø 2 mm (120 mm)
<b>Wave length</b>	655 nm
<b>Laser class</b>	I
<b>Adjustment</b>	Potentiometer (Sensing range)
<b>Special applications</b>	Detecting small objects
<b>Special features</b>	Signal strength light bar

<sup>1)</sup> Object with 90 % reflectance (referred to standard white, DIN 5033).

<sup>2)</sup> Object with 6 % reflectance (referred to standard black, DIN 5033).

<sup>3)</sup> Average service life: 50,000 h at T<sub>U</sub> = +25 °C.

<sup>4)</sup> CLASS 1 LASER PRODUCT EN60825-1:2014; IEC60825-1:2014; Maximum pulse power < 2,5 mW, Pulse length: 4 µs, Wavelength: 650 ... 670 nm; Complies with 21 CFR 1040.10 and 1040.11 except for deviations pursuant to Laser Notice No. 50, dated June 24, 2007.



## Mechanics/electronics

<b>Supply voltage</b>	10 V DC ... 30 V DC <sup>1) 2)</sup>
<b>Ripple</b>	< 5 V <sub>pp</sub> <sup>3)</sup>
<b>Power consumption</b>	20 mA <sup>4)</sup>
<b>Switching output</b>	PNP <sup>5)</sup>
<b>Output function</b>	Complementary
<b>Switching mode</b>	Light/dark switching <sup>5)</sup>
<b>Output current I<sub>max.</sub></b>	≤ 100 mA
<b>Response time</b>	≤ 0.5 ms <sup>6)</sup>
<b>Switching frequency</b>	1,000 Hz <sup>7)</sup>
<b>Connection type</b>	Male connector M12, 4-pin
<b>Circuit protection</b>	A <sup>8)</sup> B <sup>9)</sup> D <sup>10)</sup>
<b>Protection class</b>	III <sup>11)</sup>
<b>Weight</b>	18 g
<b>Housing material</b>	Plastic, VISTAL®
<b>Optics material</b>	Plastic, PMMA
<b>Enclosure rating</b>	IP67 IP69K
<b>Ambient operating temperature</b>	-30 °C ... +55 °C <sup>12)</sup>
<b>Ambient storage temperature</b>	-40 °C ... +70 °C
<b>UL File No.</b>	E189383

1) Above T<sub>a</sub> 50 °C, max. voltage = 24V and max. current = 50 mA.

2) Limit values when operated in short-circuit protected network: max. 8 A.

3) May not exceed or fall below U<sub>v</sub> tolerances.

4) Without load.

5) Q1 = light switching; Q2 = dark switching.

6) Signal transit time with resistive load.

7) With light/dark ratio 1:1.

8) A = V<sub>S</sub> connections reverse-polarity protected.

9) B = inputs and output reverse-polarity protected.

10) D = outputs overcurrent and short-circuit protected.

11) Reference voltage: 50 V DC.

12) Below T<sub>a</sub> = -10 °C, sensor must be turned on at T<sub>a</sub> > -10 °C. Sensor cannot be turned on below T<sub>a</sub> = -10 °C.

## Classifications

<b>ECl@ss 5.0</b>	27270904
<b>ECl@ss 5.1.4</b>	27270904
<b>ECl@ss 6.0</b>	27270904
<b>ECl@ss 6.2</b>	27270904
<b>ECl@ss 7.0</b>	27270904
<b>ECl@ss 8.0</b>	27270904
<b>ECl@ss 8.1</b>	27270904
<b>ECl@ss 9.0</b>	27270904

<b>ETIM 5.0</b>	EC002719
<b>ETIM 6.0</b>	EC002719
<b>UNSPSC 16.0901</b>	39121528

## Connection diagram

Cd-243

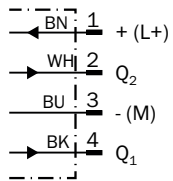

## Characteristic curve

% of sensing range

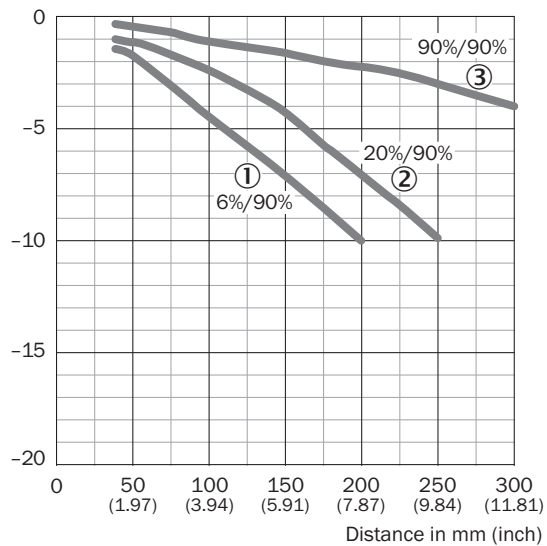

- ① Sensing range on black, 6% remission
- ② Sensing range on gray, 20 % remission
- ③ Sensing range on white, 90% remission

### Light spot size

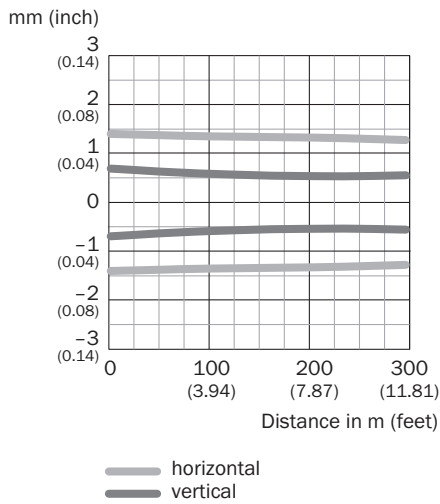

### Sensing range diagram

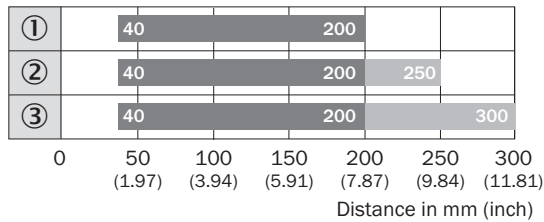

- Sensing range
- Sensing range max.
- ① Sensing range on black, 6% remission
- ② Sensing range on gray, 20% remission
- ③ Sensing range on white, 90% remission

### Functions

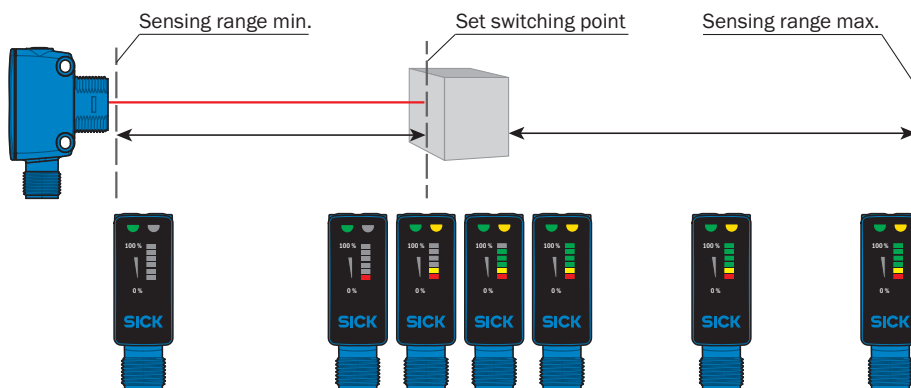

**Dimensional drawing** (Dimensions in mm (inch))

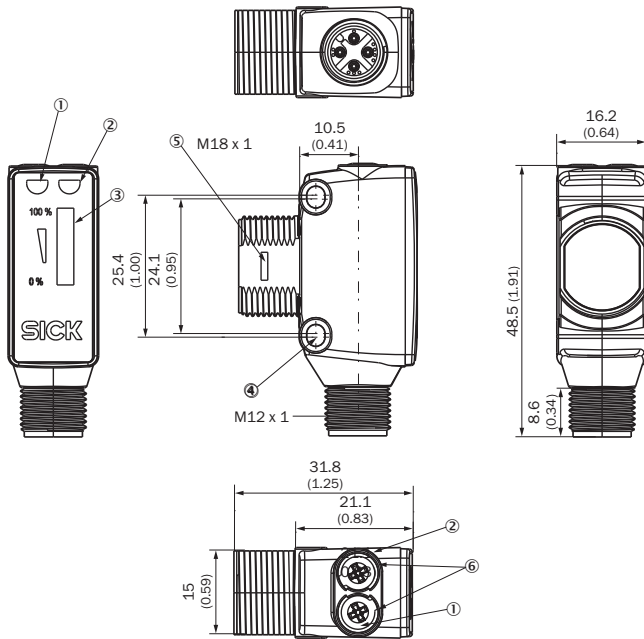

H18, DC, male connector M12





- ① LED indicator green: power on
- ② LED indicator yellow: Status of received light beam
- ③ Signal strength light bar
- ④ M3 mounting hole
- ⑤ Snap Connection for flush ring (sold separately)
- ⑥ Potentiometer (if selected) or LED Indicators

**Recommended accessories**

Other models and accessories → [www.sick.com/SureSense](http://www.sick.com/SureSense)

	Brief description	Type	Part no.
<b>Mounting brackets and plates</b>			
	Mounting plate for M18 sensors, steel, zinc coated, without mounting hardware	BEF-WG-M18	5321870
	Mounting bracket for M18 sensors, steel, zinc coated, without mounting hardware	BEF-WN-M18	5308446
	Bottom M18 mounting bracket SureSense sensors	MB-M18-H18	2085820
<b>Other mounting accessories</b>			
	Spherical bearing M18	Ball holder	4057409
	Mounting bracket	MB-BS18MM-M4	2049694
<b>Terminal and alignment brackets</b>			
	Clamping block for round sensors M18, without fixed stop, plastic (PA12), glass-fiber reinforced, mounting hardware included	BEF-KH-M18	2051481

	<b>Brief description</b>	<b>Type</b>	<b>Part no.</b>
<b>Plug connectors and cables</b>			
	Head A: female connector, M12, 4-pin, straight Head B: Flying leads Cable: PVC, unshielded, 2 m	DOL-1204-G02M	6009382
	Head A: female connector, M12, 4-pin, straight Head B: Flying leads Cable: PVC, unshielded, 5 m	DOL-1204-G05M	6009866
	Head A: female connector, M12, 4-pin, angled Head B: Flying leads Cable: PVC, unshielded, 2 m	DOL-1204-W02M	6009383
	Head A: female connector, M12, 4-pin, angled Head B: Flying leads Cable: PVC, unshielded, 5 m	DOL-1204-W05M	6009867



## SICK AT A GLANCE

SICK is one of the leading manufacturers of intelligent sensors and sensor solutions for industrial applications. A unique range of products and services creates the perfect basis for controlling processes securely and efficiently, protecting individuals from accidents and preventing damage to the environment.

We have extensive experience in a wide range of industries and understand their processes and requirements. With intelligent sensors, we can deliver exactly what our customers need. In application centers in Europe, Asia and North America, system solutions are tested and optimized in accordance with customer specifications. All this makes us a reliable supplier and development partner.

Comprehensive services complete our offering: SICK LifeTime Services provide support throughout the machine life cycle and ensure safety and productivity.

For us, that is “Sensor Intelligence.”

## WORLDWIDE PRESENCE:

Contacts and other locations [www.sick.com](http://www.sick.com)