



Chipsmall Limited consists of a professional team with an average of over 10 year of expertise in the distribution of electronic components. Based in Hongkong, we have already established firm and mutual-benefit business relationships with customers from,Europe,America and south Asia,supplying obsolete and hard-to-find components to meet their specific needs.

With the principle of “Quality Parts,Customers Priority,Honest Operation,and Considerate Service”,our business mainly focus on the distribution of electronic components. Line cards we deal with include Microchip,ALPS,ROHM,Xilinx,Pulse,ON,Everlight and Freescale. Main products comprise IC,Modules,Potentiometer,IC Socket,Relay,Connector.Our parts cover such applications as commercial,industrial, and automotives areas.

We are looking forward to setting up business relationship with you and hope to provide you with the best service and solution. Let us make a better world for our industry!



Contact us

Tel: +86-755-8981 8866 Fax: +86-755-8427 6832

Email & Skype: info@chipsmall.com Web: www.chipsmall.com

Address: A1208, Overseas Decoration Building, #122 Zhenhua RD., Futian, Shenzhen, China



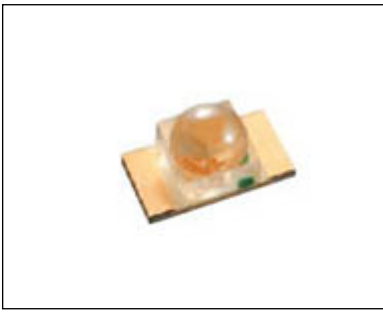

**Pb-free
HEAT**

STANLEY

1105W Series

Single Color Ultra High Brightness Type

Features

Package	3216 Dome Lens Type, Water Clear resin
Product features	<ul style="list-style-type: none"> • Outer Dimension 3.2 x 1.6 x 1.85mm (L x W x H) • Temperature range <ul style="list-style-type: none"> Storage Temperature : InGaN : -40°C~100°C ALGaInP: -40°C~120°C Operating Temperature : InGaN : -40°C~ 85°C ALGaInP : -40°C~100°C • Lead-free soldering compatible • RoHS compliant
Dominant wavelength	Blue : 470nm(SB,HUB) Blue Green : 508nm(HUC) Green : 530nm(SG,HUG) Yellow : 590nm(UY) Red : 630nm(UR)
Half Intensity Angle	50 deg. (HUB,HUC,HUG,UY,UR) 25 deg. (SB,SG)
Die materials	SB,SG,HUB,HUC,HUG : InGaN UY,UR : ALGaInP
Rank grouping parameter	Sorted by luminous intensity and wavelength per rank taping
Assembly method	Auto pick & place machine (Auto Mounter)
Soldering methods	Reflow soldering
Taping and reel	2,000pcs per reel in a 8mm width tape. (Standard) Reel diameter: ϕ 180mm
ESD	InGaN : Up to 1kV(HBM), ALGaInP : Up to 2kV(HBM)

Recommended Applications

Amusement Equipment, Electric Household Appliances, OA/FA, Other General Applications

Color and Luminous Intensity

(Ta=25°C)

Part No.	Material	Emitted Color	Lens Color	Dominant Wavelength		Luminous Intensity		
				λ_d (nm)		I_v (mcd)		
				TYP.	I_f (mA)	MIN.	TYP.	I_f (mA)
SB1105W	InGaN	Blue		470	10	150	330	10
HUB1105W	InGaN	Blue	Water Clear	470	10	70	200	10
HUC1105W	InGaN	Blue Green		508	10	140	560	10
SG1105W	InGaN	Green		530	10	680	1500	10
HUG1105W	InGaN	Green		530	10	200	560	10
UY1105W	AlGaInP	Yellow		590	20	140	500	20
UR1105W	AlGaInP	Red		630	20	140	500	20

Absolute Maximum Ratings

(Ta=25°C)

Item	Symbol	Absolute Maximum Ratings							Unit
		SB	HUB	HUC	SG	HUG	UY	UR	
Power Dissipation	P_d	70	78	78	70	78	87	87	mW
Forward Current	I_F	20	20	20	20	20	30	30	mA
Pulse Forward Current ※1	I_{FRM}	48	48	48	48	48	100	100	mA
Derating (Ta=25°C or higher)	ΔI_F	0.26	0.28	0.28	0.26	0.28	1.00※2	1.00※2	mA/°C
	ΔI_{FRM}	0.64	0.69	0.69	0.64	0.69	3.33※2	3.33※2	mA/°C
Reverse Voltage	V_R	5	5	5	5	5	5	5	V
Operating Temperature	T_{opr}	-40~+85					-40~+100		°C
Storage Temperature	T_{stg}	-40~+100					-40~+120		°C

※1 I_{FRM} Measurement condition : Pulse Width ≤ 1 ms., Duty $\leq 1/20$. (UY,UR : Duty $\leq 1/10$)

※2 Temperature Condition : Ta=75°C or higher.

Electro-Optical Characteristics(SB,SG,HUB,HUC,HUG)

(Ta=25°C)

Item	Conditions	Symbol	Characteristics					Unit	
			SB	HUB	HUC	SG	HUG		
Forward Voltage	I _F =10mA	V _F	TYP.	2.9	3.4	3.4	2.9	3.4	V
			MAX.	3.4	3.9	3.9	3.4	3.9	
Reverse Current	V _R =5V	I _R	MAX.	100	100	100	100	100	μ A
Peak Wavelength	I _F =10mA	λ _p	TYP.	465	465	502	522	522	nm
Dominant Wavelength	I _F =10mA	λ _d	TYP.	470	470	508	530	530	nm
Spectral Line Half Width	I _F =10mA	Δλ	TYP.	22	26	30	35	35	nm
Half Intensity Angle	I _F =10mA	2θ 1/2	TYP.	25	50	50	25	50	deg.

Electro-Optical Characteristics(UY,UR)

(Ta=25°C)

Item	Conditions	Symbol	Characteristics		Unit	
			UY	UR		
Forward Voltage	I _F =20mA	V _F	TYP.	2.2	2.2	V
			MAX.	2.8	2.8	
Reverse Current	V _R =5V	I _R	MAX.	100	100	μ A
Peak Wavelength	I _F =20mA	λ _p	TYP.	592	641	nm
Dominant Wavelength	I _F =20mA	λ _d	TYP.	590	630	nm
Spectral Line Half Width	I _F =20mA	Δλ	TYP.	18	18	nm
Half Intensity Angle	I _F =20mA	2θ 1/2	TYP.	50	50	deg.

Luminous Intensity Rank (Unit : mcd)

(Ta=25°C)

Tolerance : +/-10%

Rank	I _v (mcd)			
	SB		SG	
	I _F =10mA		I _F =10mA	
	MIN.	MAX.	MIN.	MAX.
CB	150	220	/	
CC	220	330		
CD	330	470		
CE	470	680		
CF	680	-	680	1,000
DA	/		1,000	1,500
DB			1,500	2,200
DC			2,200	3,300
DD			3,300	-

Rank	I _v (mcd)									
	HUB		HUC		HUG		UY		UR	
	I _F =10mA		I _F =10mA		I _F =10mA		I _F =20mA		I _F =20mA	
	MIN.	MAX.	MIN.	MAX.	MIN.	MAX.	MIN.	MAX.	MIN.	MAX.
A	/		140	280	/		140	280	140	280
B	70	140	200	400	200	400	200	400	200	400
C	100	200	280	560	280	560	280	560	280	560
D	140	280	400	800	400	800	400	800	400	800
E	200	400	560	1,120	560	1,120	560	1,120	560	1,120
F	280	560	800	-	800	1,600	800	-	800	-
G	400	-	/		1,120	-	/		/	

※ Please contact our sales staff concerning rank designation.

Color Tone Groups (λ d)

(Ta=25°C)

Tolerance : +/-2nm

Rank	Dominant Wavelength λd (nm)			
	SB		SG	
	IF=10mA		IF=10mA	
	MIN.	MAX.	MIN.	MAX.
A	460.0	470.0	520.0	532.5
B	470.0	480.0	532.5	545.0

Rank	Dominant Wavelength λ d (nm)					
	UB		UC		UG	
	I _F =10mA		I _F =10mA		I _F =10mA	
	MIN.	MAX.	MIN.	MAX.	MIN.	MAX.
-	460	480	500	520	520	545

Rank	Dominant Wavelength λ d (nm)			
	UY		UR	
	I _F =20mA		I _F =20mA	
	MIN.	MAX.	MIN.	MAX.
A	580	585	620	630
B	584	589	628	638
C	588	593	/	
D	592	597		
E	596	601		

※ Please contact our sales staff concerning rank designation.

Technical Data(SB,SG)

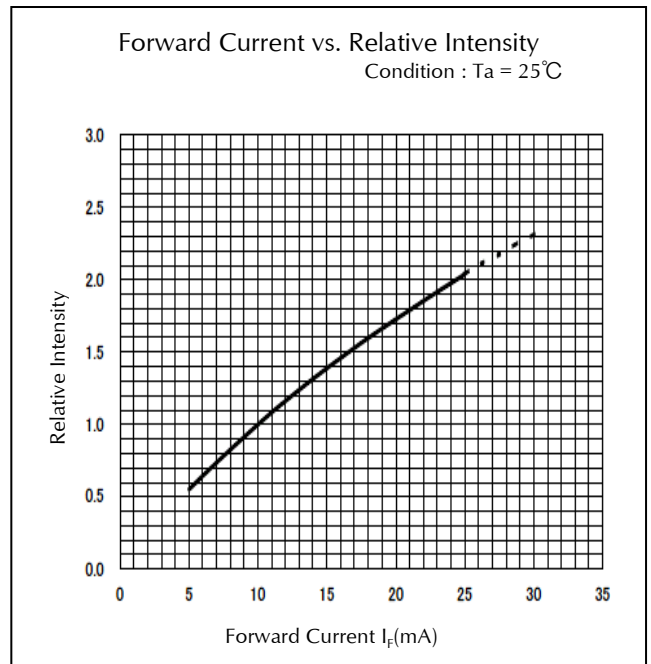
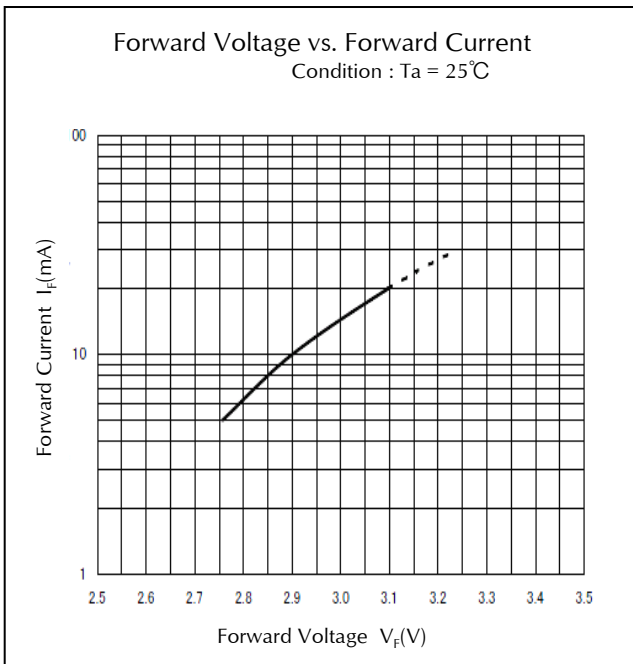
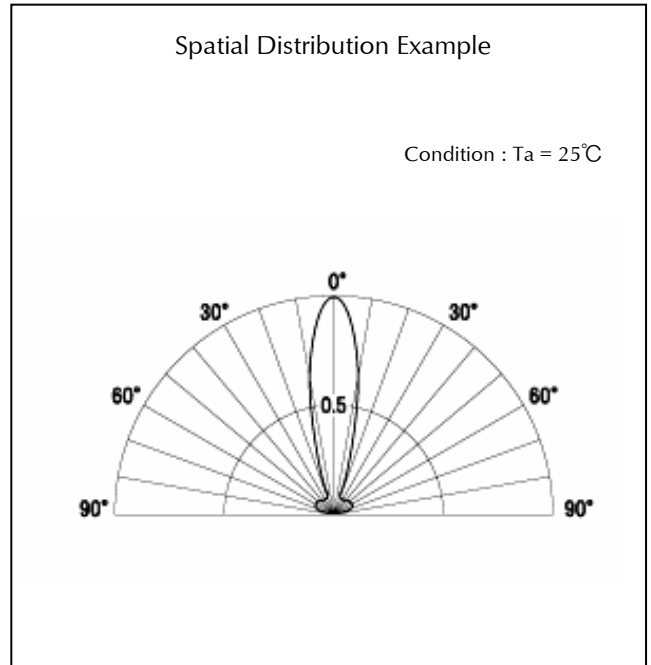
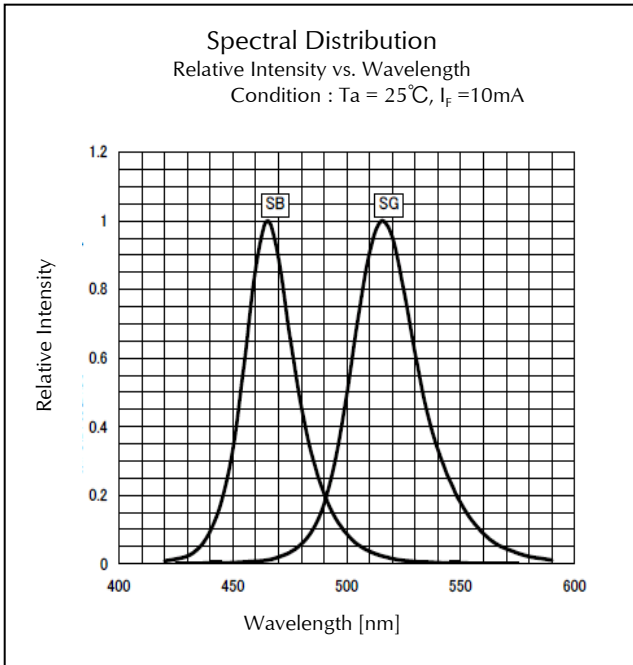

Technical Data(SB,SG)

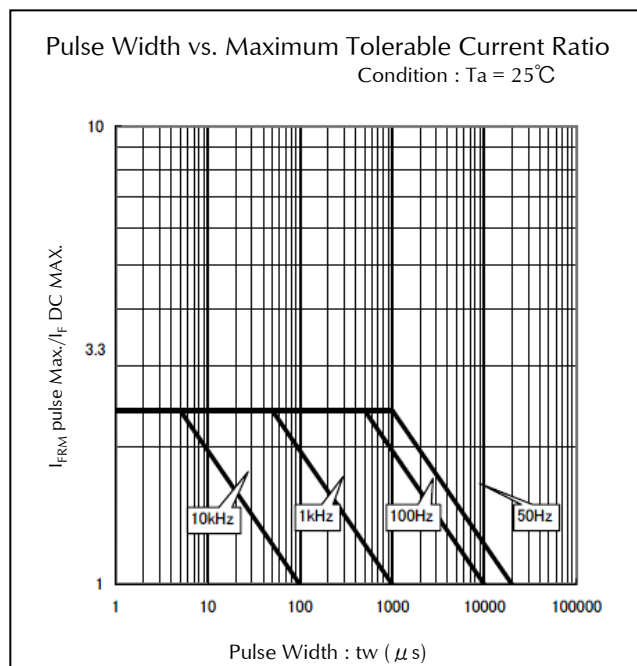
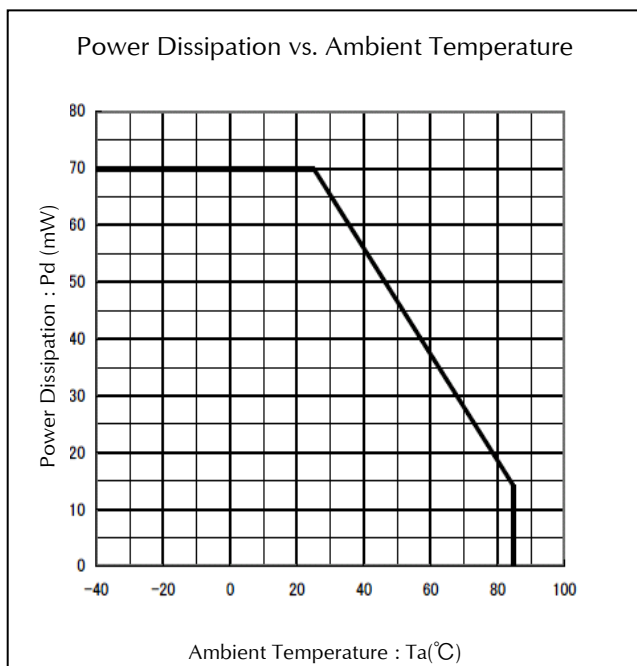
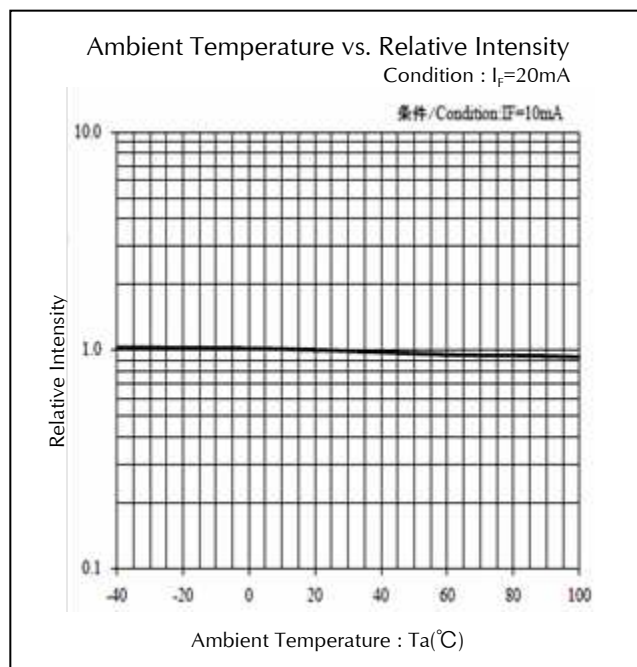
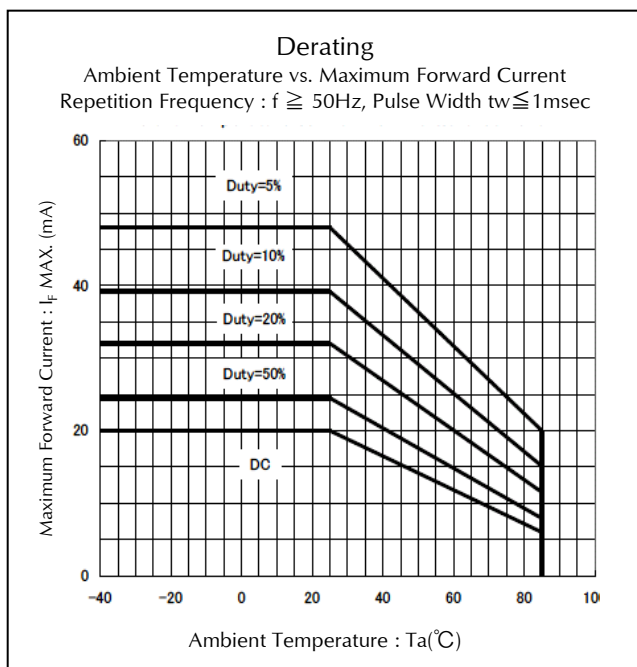

Technical Data(SB,SG)

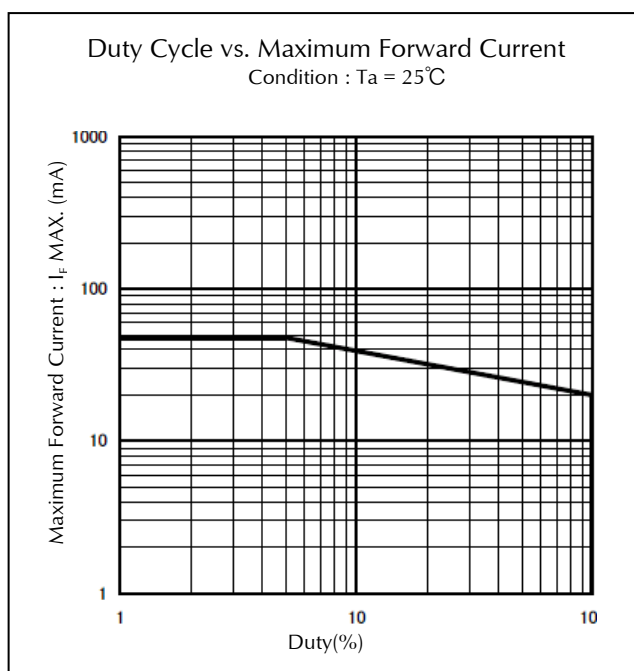
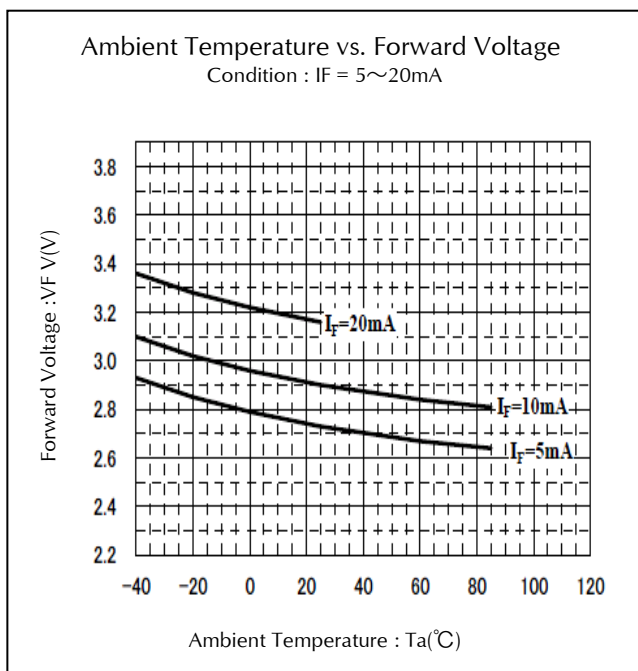

Technical Data(HUB)

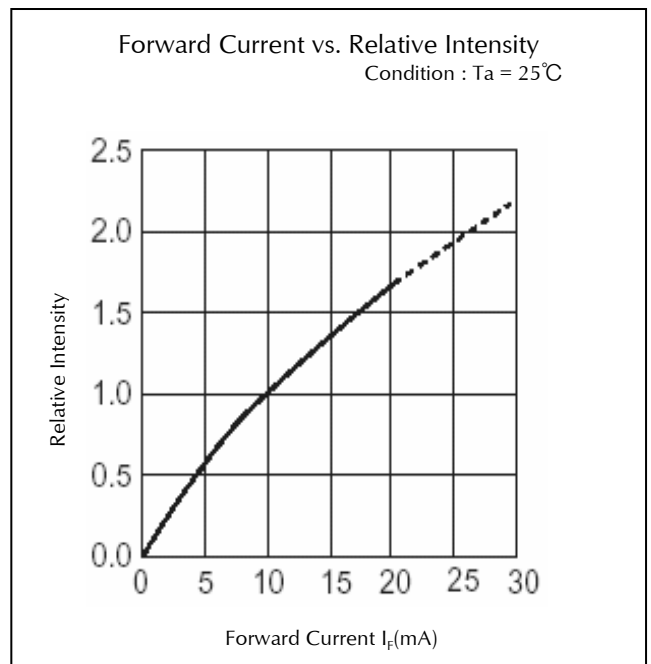
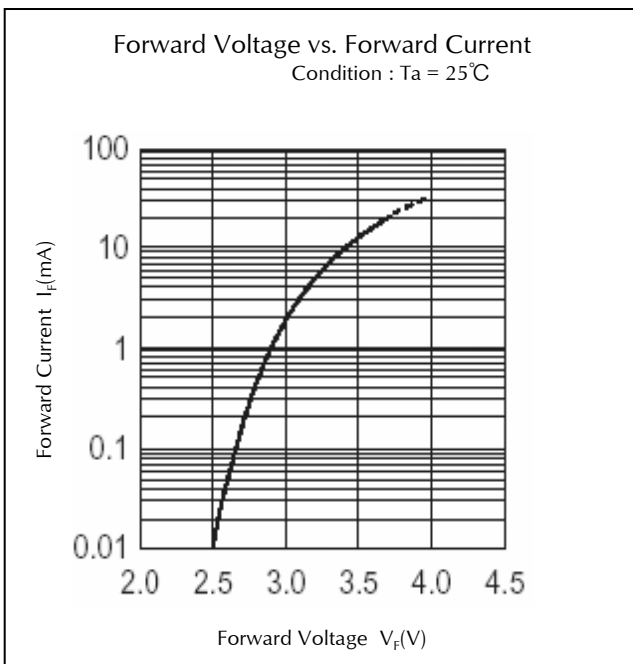
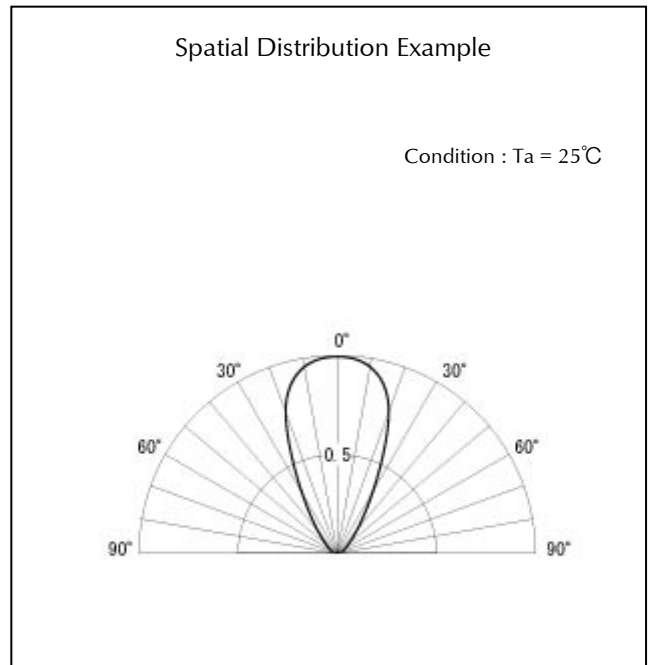
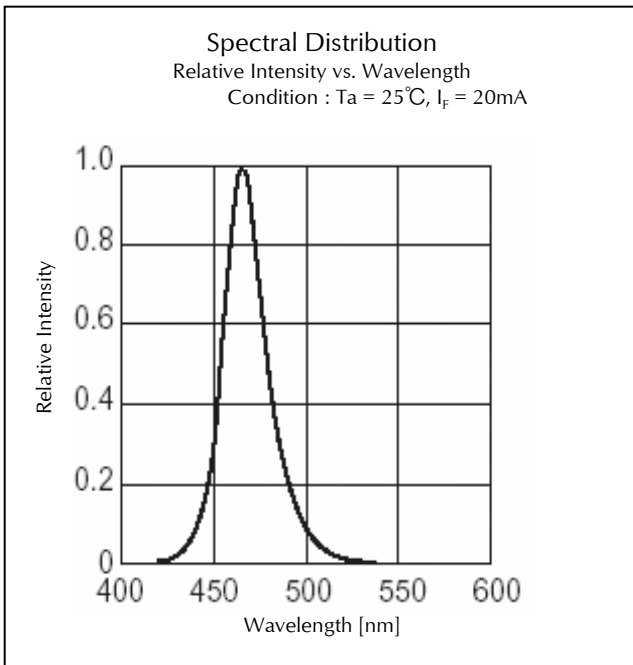

Technical Data(HUB)

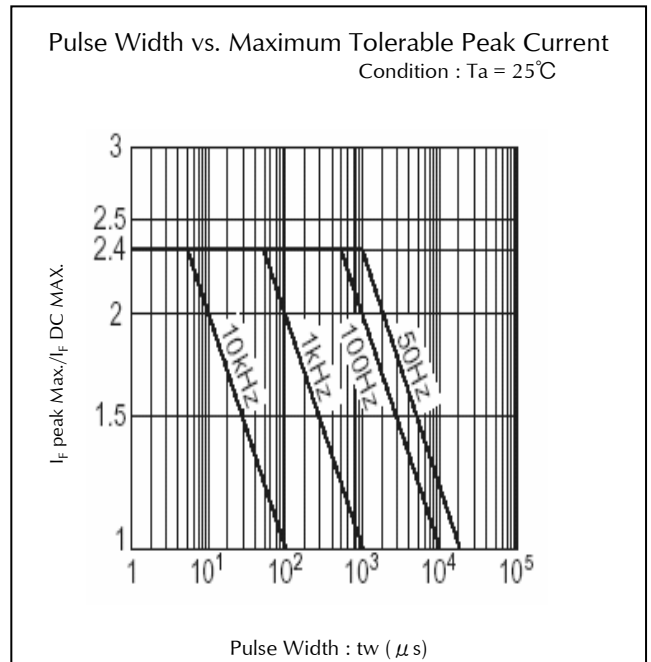
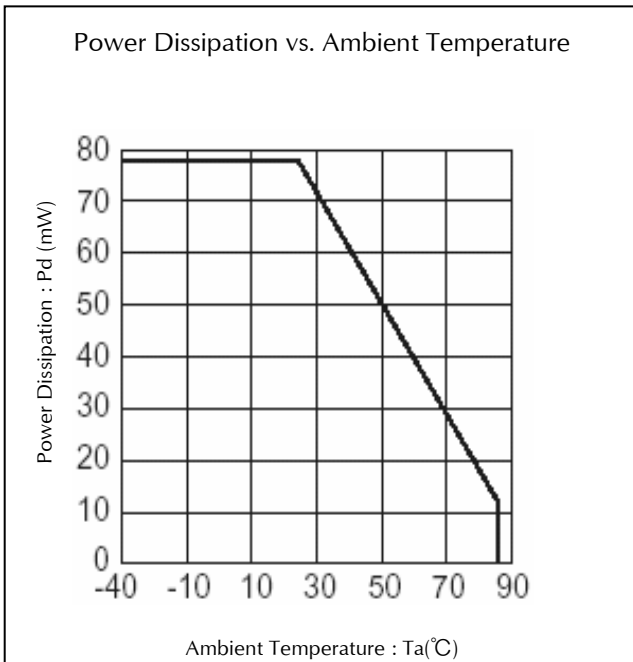
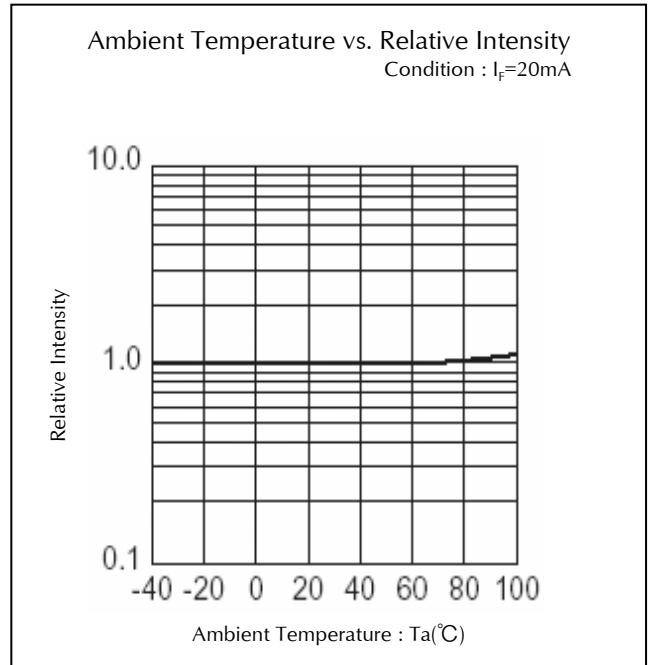
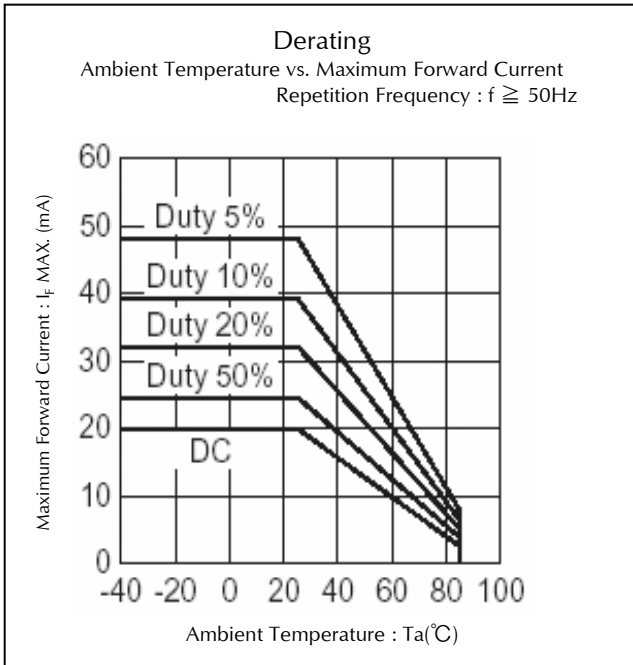

Technical Data(HUC)

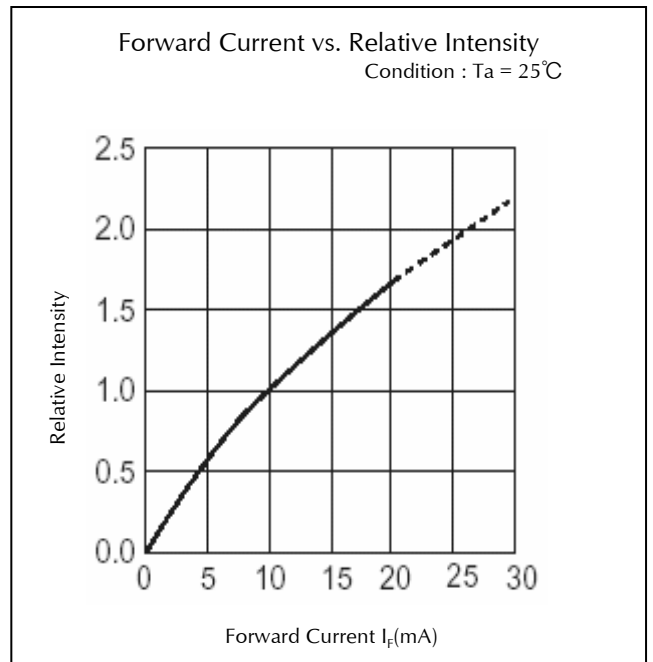
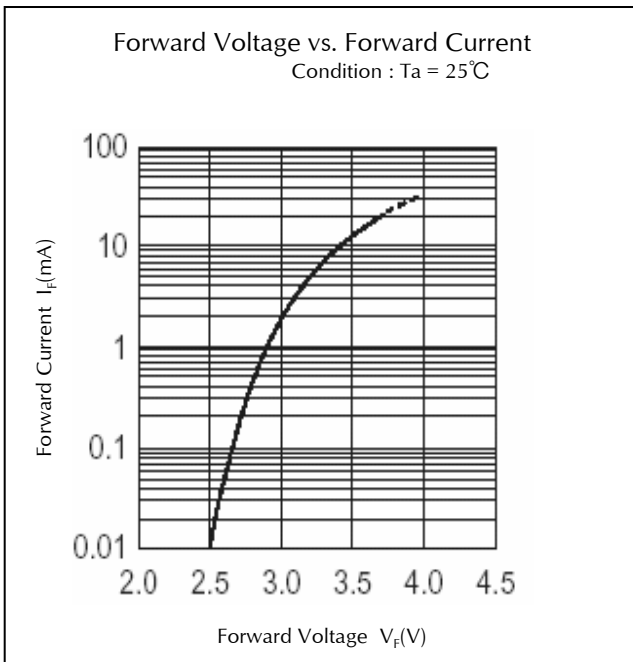
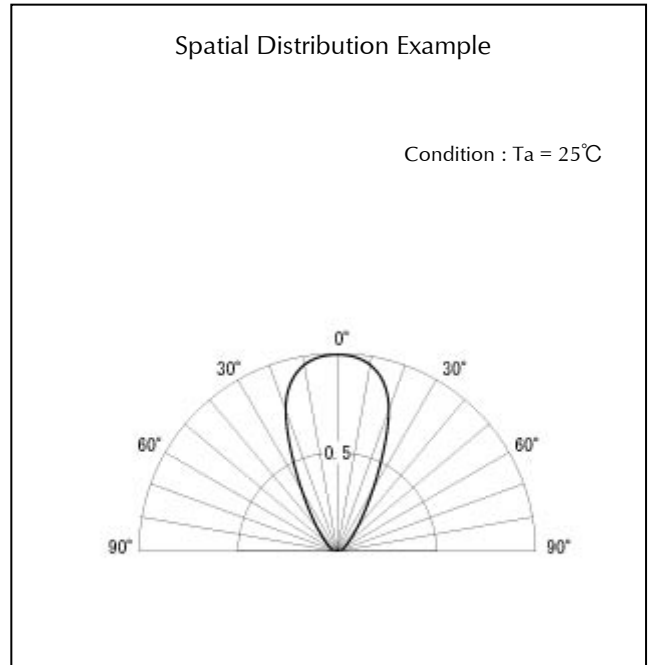
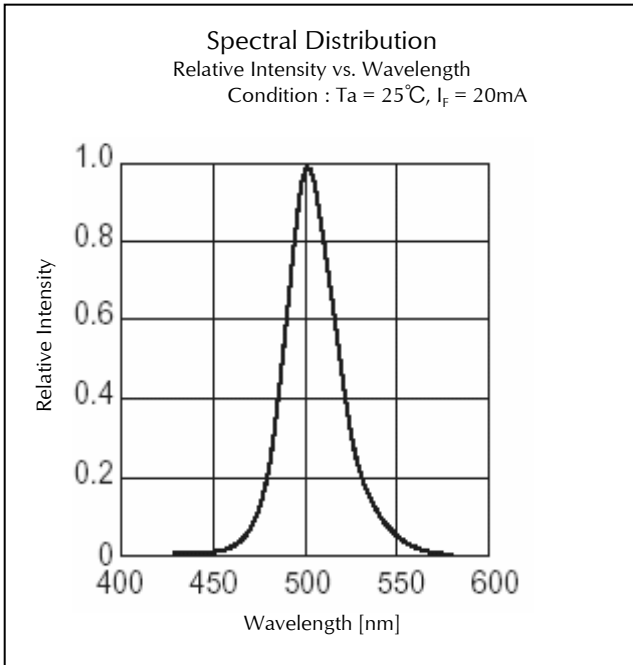

Technical Data(HUC)

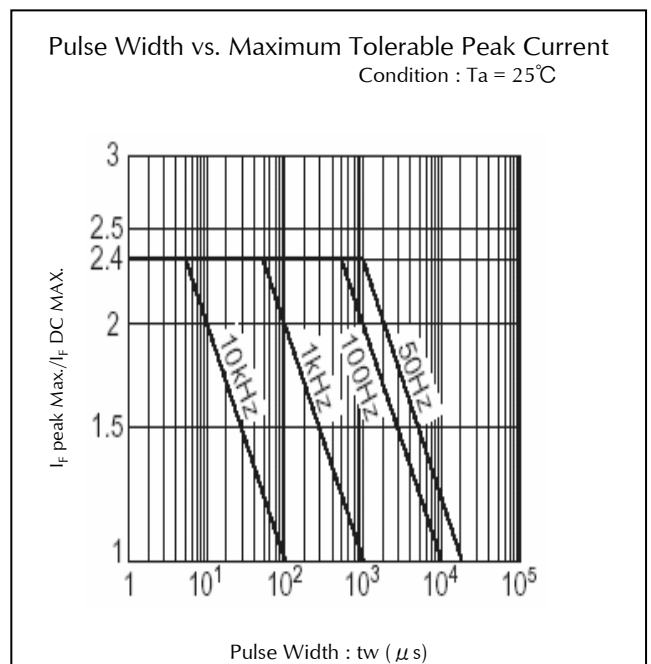
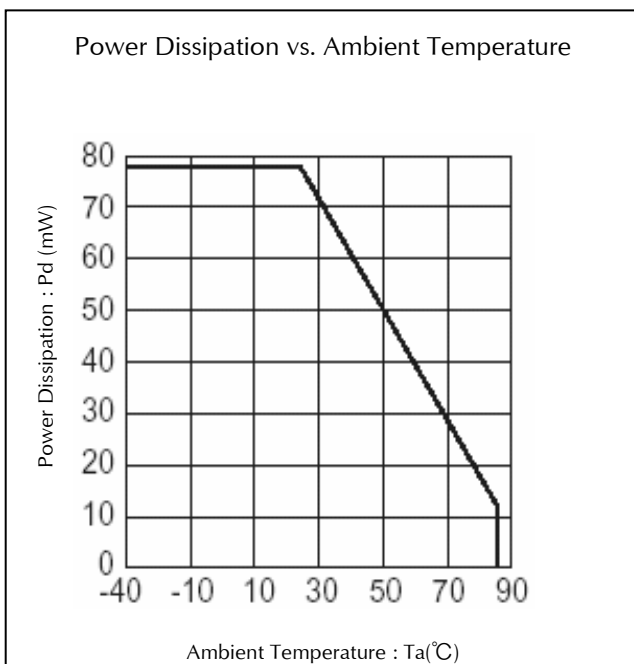
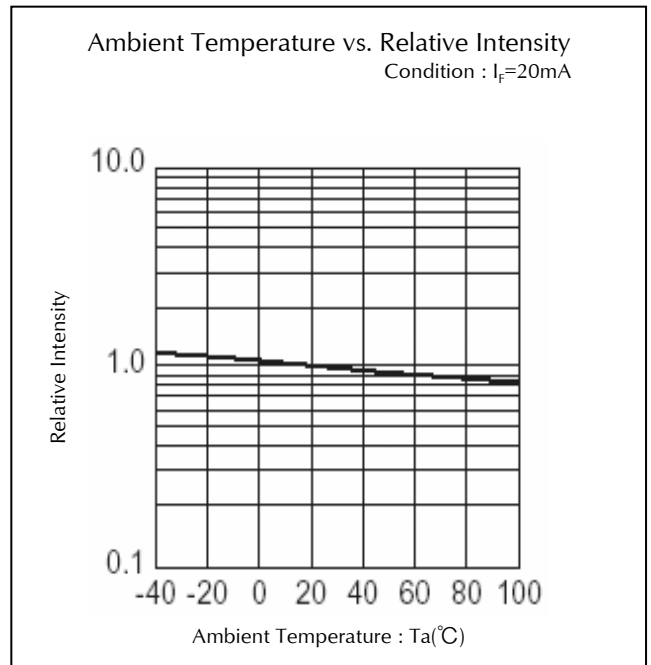
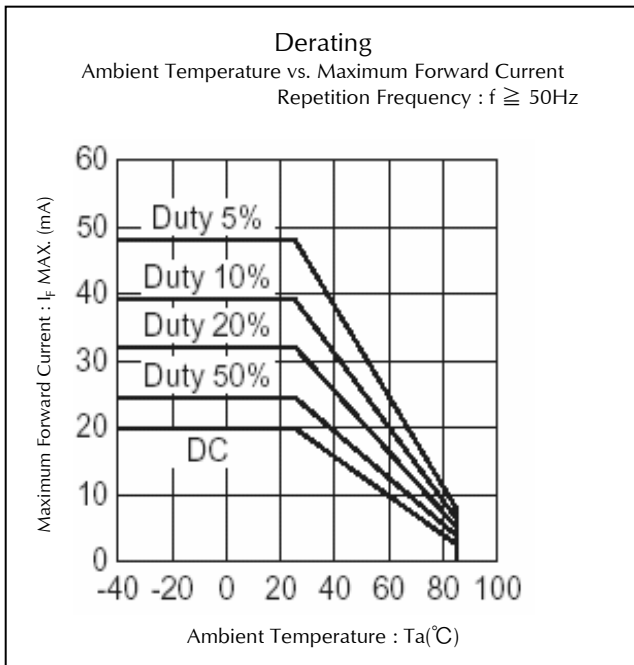

Technical Data(HUG)

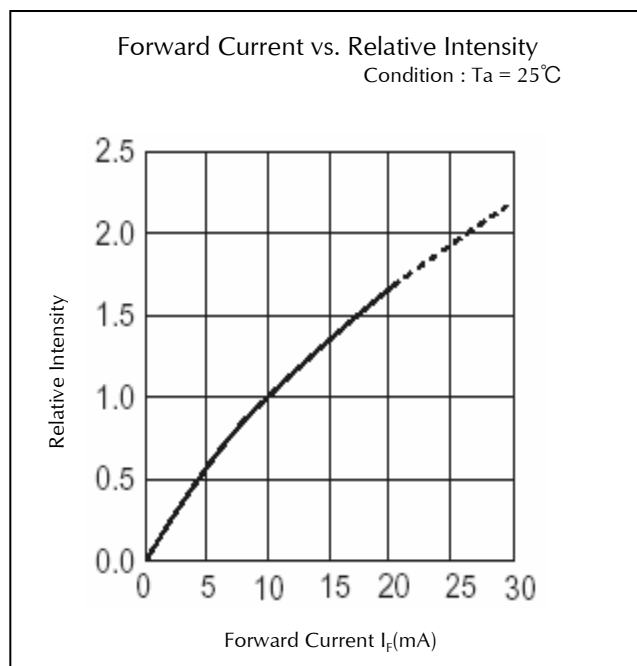
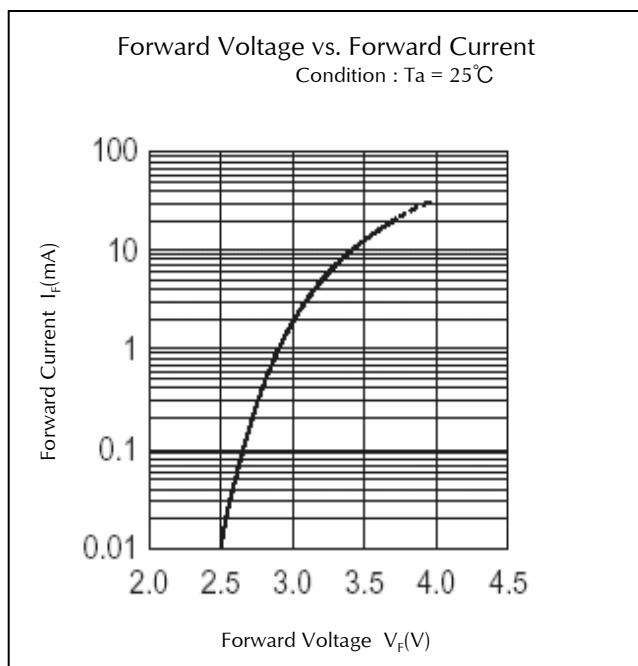
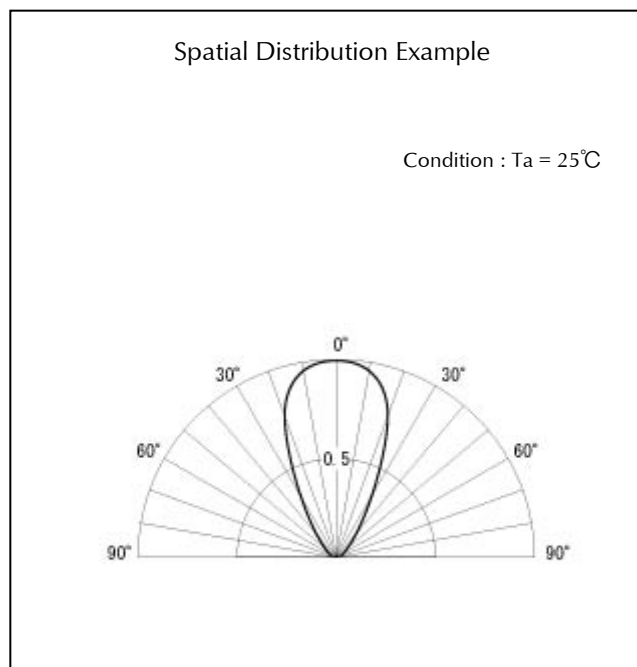
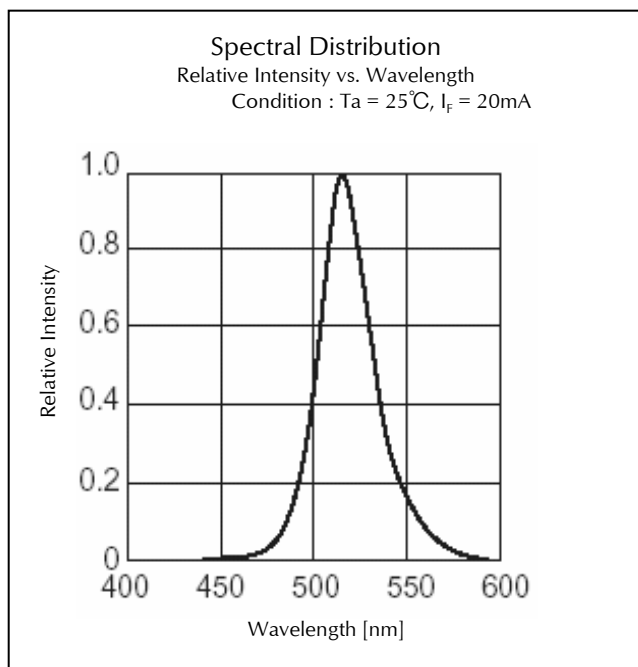

Technical Data(UY)

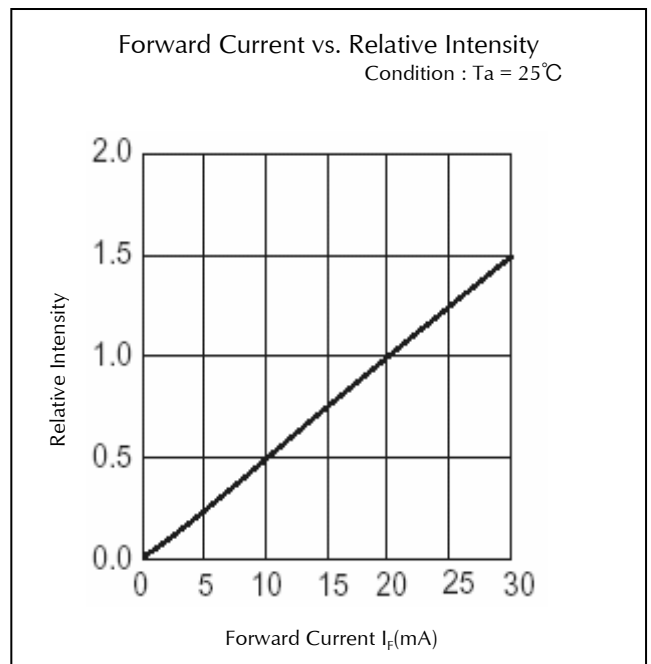
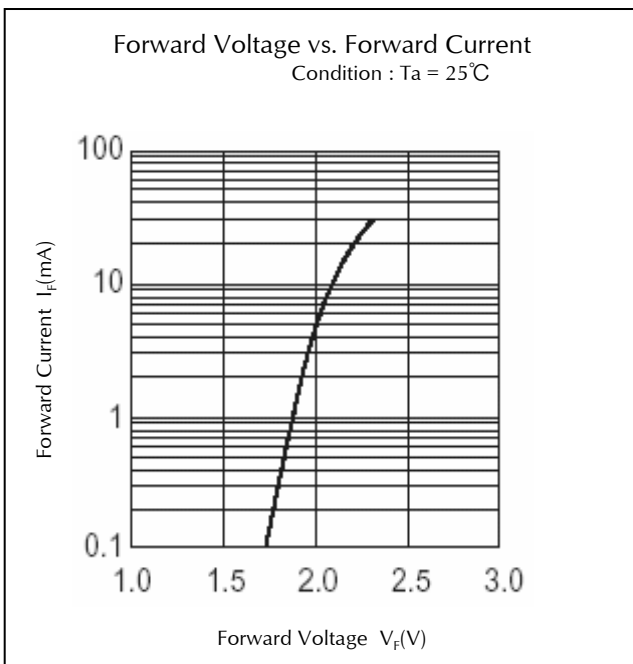
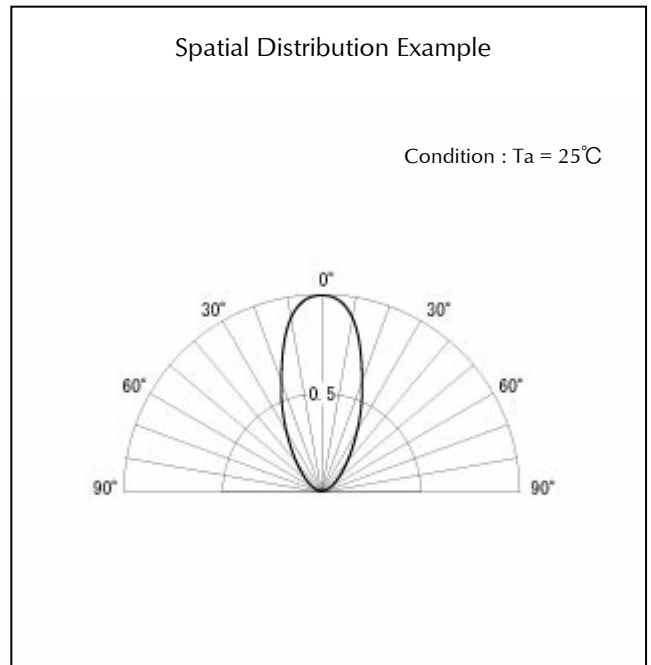
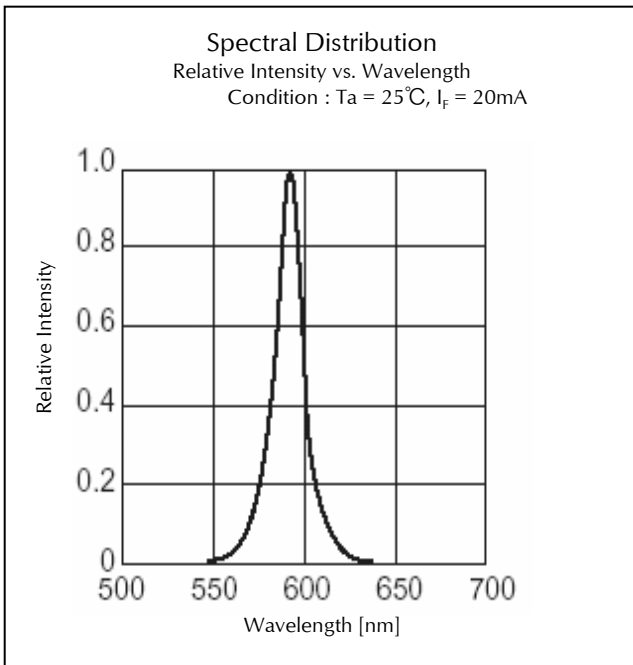

Technical Data(UY)

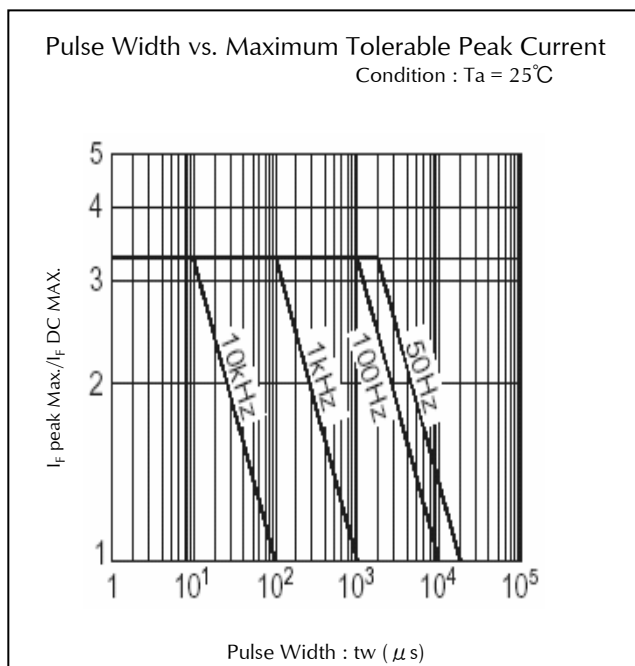
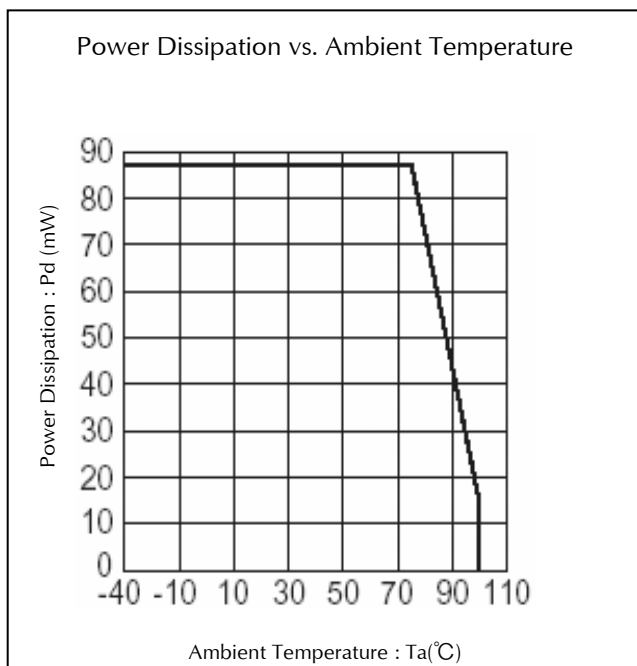
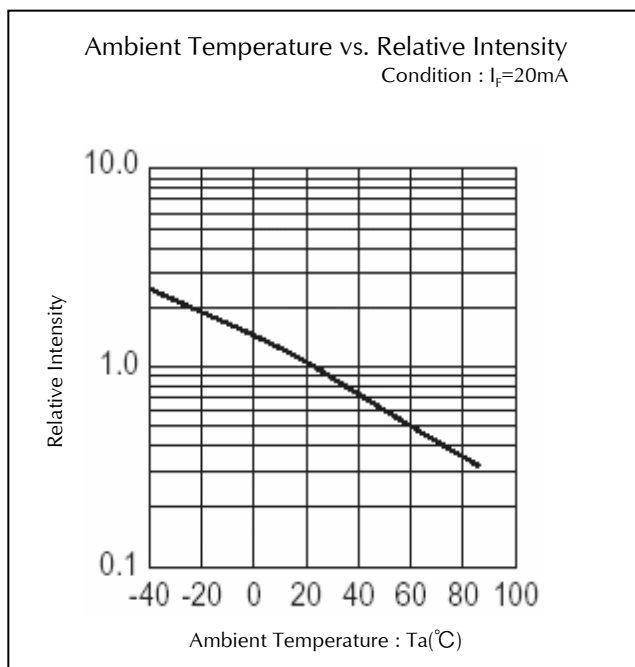
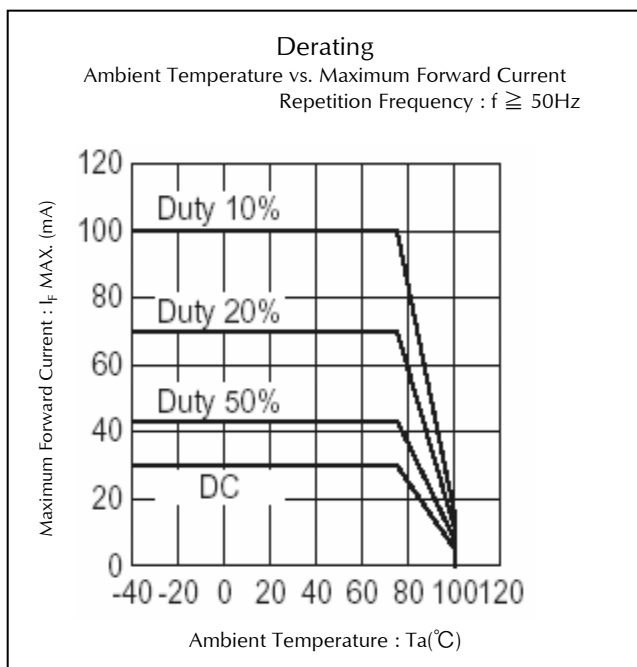

Technical Data(UR)

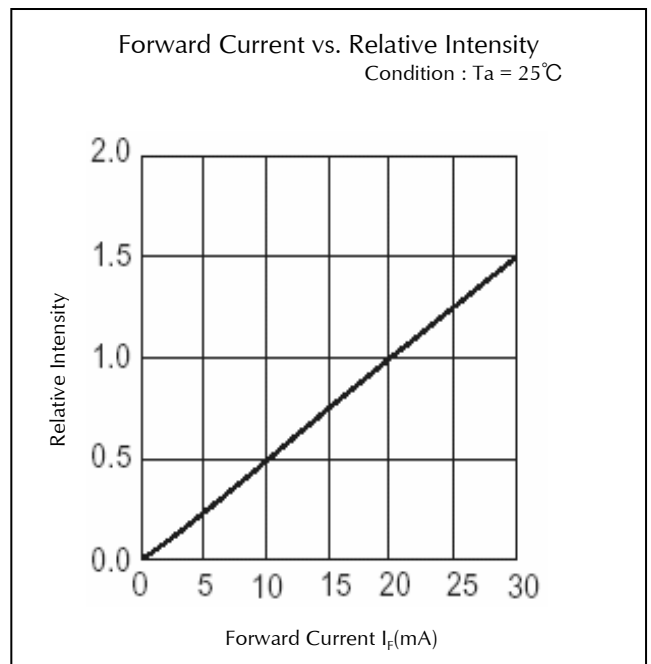
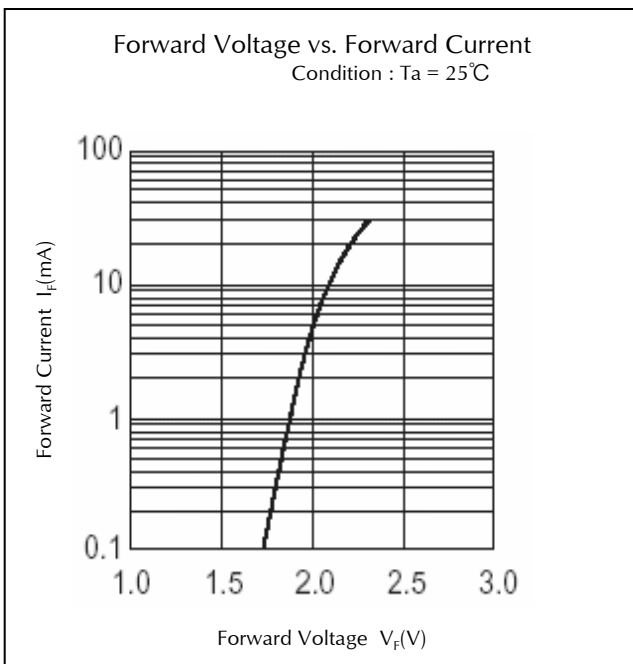
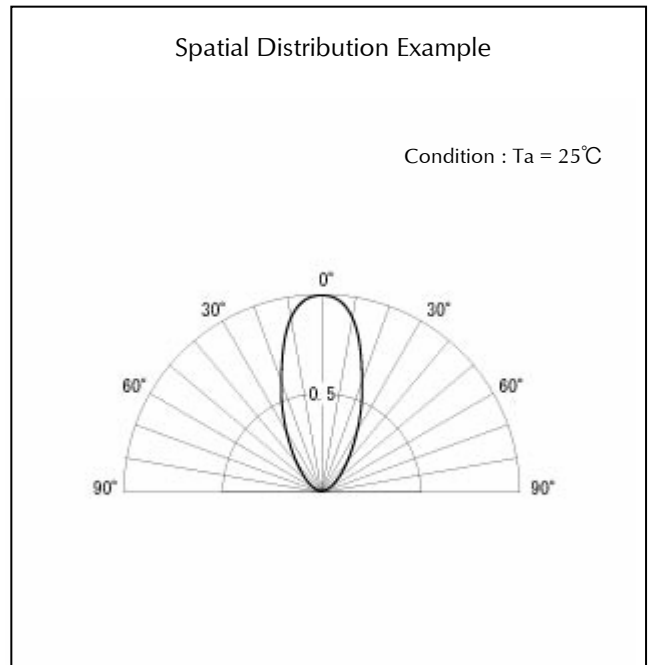
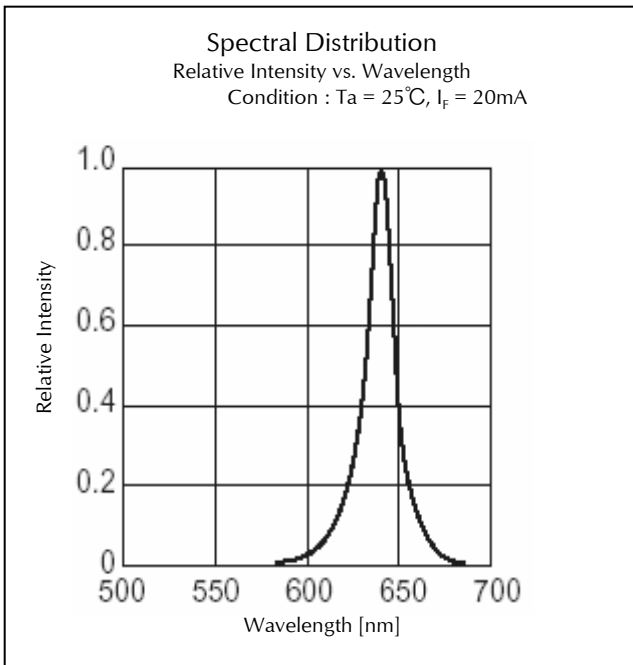

Technical Data(UR)

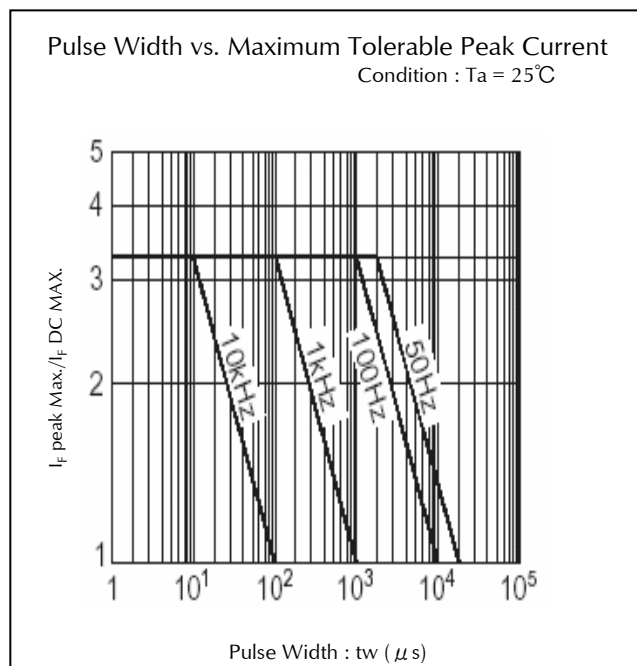
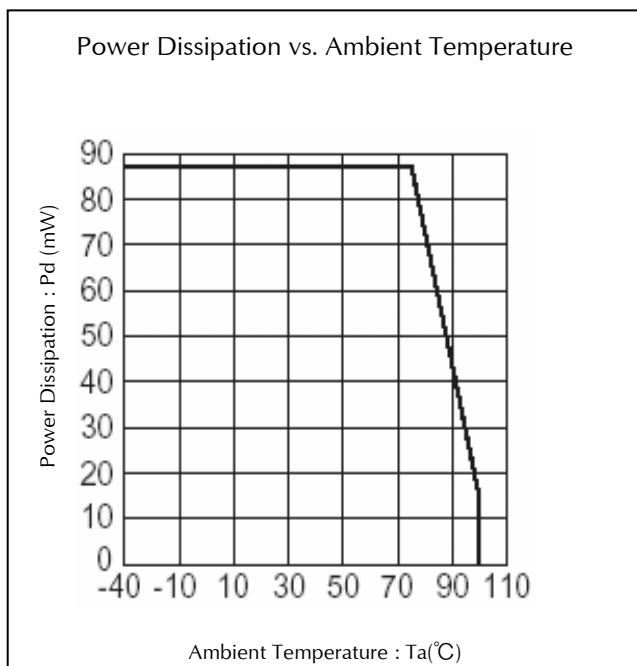
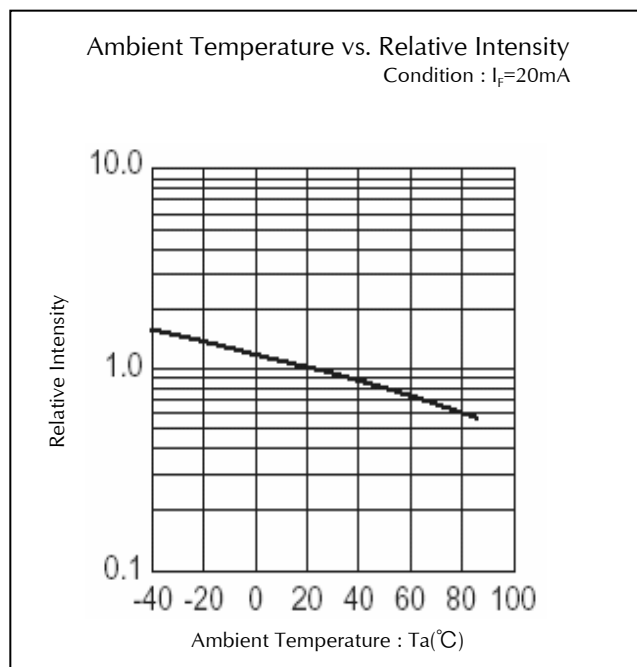
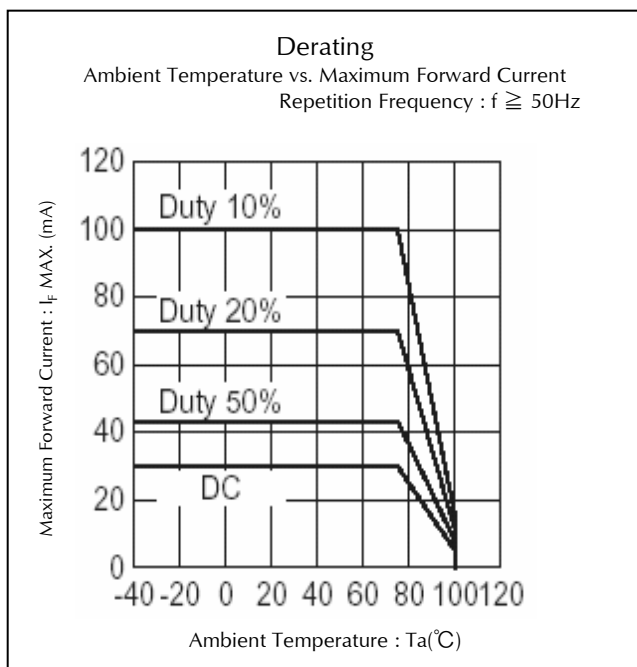

Package Dimensions

(Unit: mm)

Weight: (7.81)mg

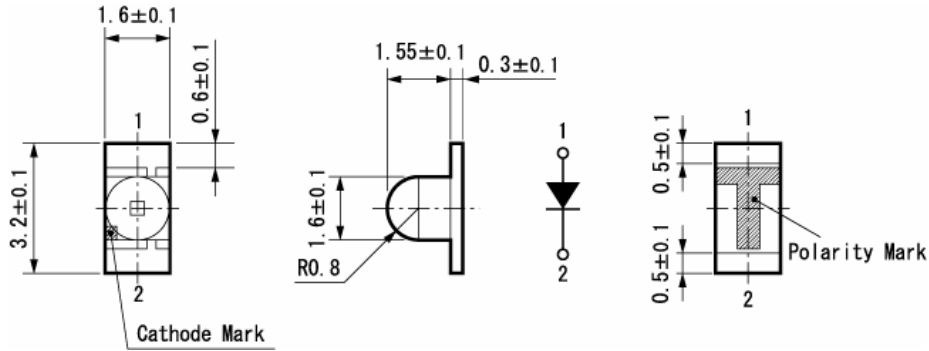

Recommended Soldering Pattern

(Unit: mm)

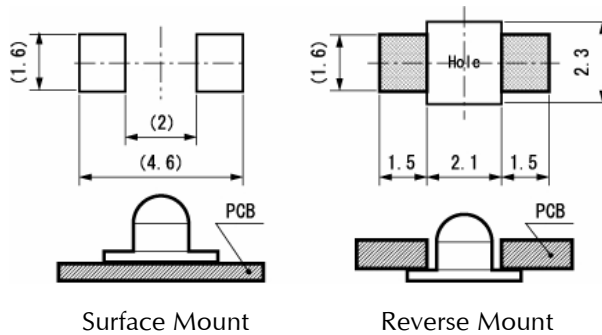

Taping Specification

(Unit: mm)

Quantity : 2,000pcs/ reel (standard)

1105W-TR (Surface Mount)

1105W-RR (Reverse Mount)

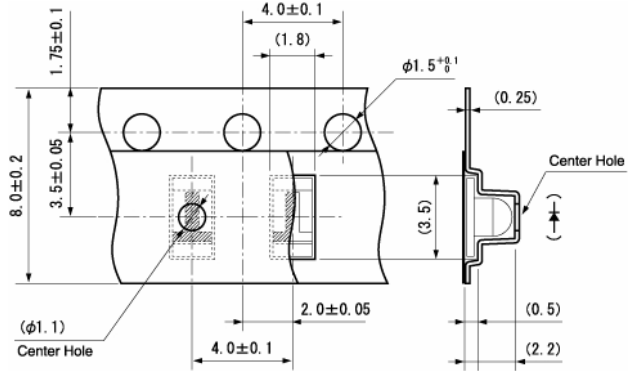
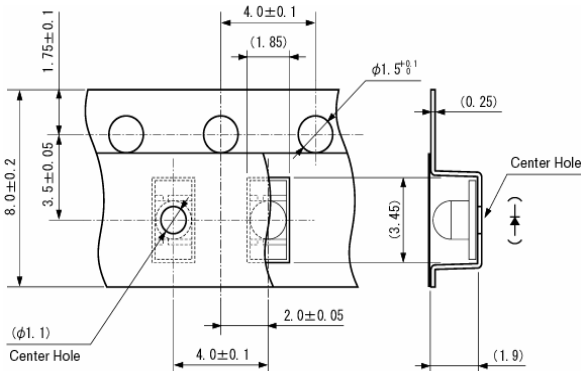

Reflow Soldering Conditions

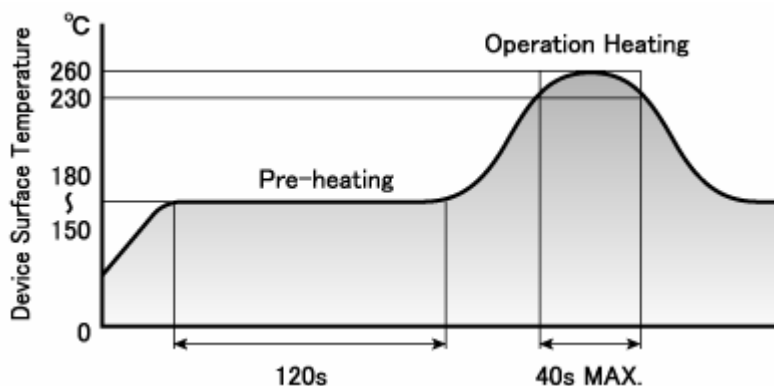

- 1) The above profile temperature gives the maximum temperature of the LED resin surface. Please set the temperature so as to avoid exceeding this range.
- 2) Total times of reflow soldering process shall be no more than 2 times. When the second reflow soldering process is performed, intervals between the first and second reflow should be short as possible (while allowing some time for the component to return to normal temperature after the first reflow) in order to prevent the LED from absorbing moisture.
- 3) Temperature fluctuation to the LED during the pre-heating process shall be minimized.

Manual Soldering Conditions

Iron tip temp.	350 °C	(MAX.)
Soldering time and frequency	3 s	(MAX.)
	1 time	(MAX.)

Reliability Testing Result(HUB,HUC,HUG)

Reliability Testing Result	Applicable Standard	Testing Conditions	Duration	Failure
Room Temp. Operating Life	EIAJ ED-4701/100(101)	Ta = 25°C, If = Maximum Rated Current	1,000 h	0/25
Resistance to Soldering Heat	EIAJ ED-4701/300(301)	Pre-heating : 150~180°C 120s Max. Operation Heating : 230°C 40s Max. Peak Temperature : 260°C	Twice	0/25
Temperature Cycling	EIAJ ED-4701/100(105)	Minimum Rated Storage Temperature(30min) ~Normal Temperature(15min) ~Maximum Rated Storage Temperature(30min) ~Normal Temperature(15min)	5 cycles	0/25
Wet High Temp. Storage Life	EIAJ ED-4701/100(103)	Ta = 60±2°C, RH = 90±5%	1,000 h	0/25
High Temp. Storage Life	EIAJ ED-4701/200(201)	Ta = Maximum Rated Storage Temperature	1,000 h	0/25
Low Temp. Storage Life	EIAJ ED-4701/200(202)	Ta = Minimum Rated Storage Temperature	1,000 h	0/25
Vibration, Variable Frequency	EIAJ ED-4701/400(403)	98.1m/s ² (10G), 100 ~ 2KHz sweep for 20min., XYZ each direction	2 h	0/10

Reliability Testing Result(SB,SG,UY,UR)

Reliability Testing Result	Applicable Standard	Testing Conditions	Duration	Failure
Room Temp. Operating Life	EIAJ ED-4701/100(101)	Ta = 25°C, If = Maximum Rated Current	1,000 h	0/25
Resistance to Soldering Heat	EIAJ ED-4701/300(301)	Pre-heating : 150~180°C 120s Max. Operation Heating : 230°C 40s Max. Peak Temperature : 260°C	Twice	0/25
Temperature Cycling	EIAJ ED-4701/100(105)	Minimum Rated Storage Temperature(30min) ~Normal Temperature(15min) ~Maximum Rated Storage Temperature(30min) ~Normal Temperature(15min)	200 cycles	0/25
High Temp. Operating Life	EIAJ ED-4701/100(101)	Ta = Maximum Rated Operating Temperature If = 17.4mA(SB,SG)/5mA(UR,UY)	1,000 h	0/25
Humidity Temp. Operating Life	EIAJ ED-4701/100(102)	Ta = 60±2°C, RH = 90±5%, If = Maximum Rated Current	1,000 h	0/25
High Temp. Storage Life	EIAJ ED-4701/200(201)	Ta = Maximum Rated Storage Temperature	1,000 h	0/25
Low Temp. Storage Life	EIAJ ED-4701/200(202)	Ta = Minimum Rated Storage Temperature	1,000 h	0/25
Vibration, Variable Frequency	EIAJ ED-4701/400(403)	98.1m/s ² (10G), 100 ~ 2KHz sweep for 20min., XYZ each direction	2 h	0/10

Failure Criteria

Items	Symbols	Conditions	Failure criteria
Luminous Intensity	Iv	If Value of each product Luminous Intensity	Testing Min. Value < Spec. Min. Value x 0.5
Forward Voltage	Vf	If Value of each product Forward Voltage	Testing Max. Value ≥ Spec. Max. Value x 1.2
Reverse Current	Ir	Vr = Maximum Rated Reverse Voltage V	Testing Max. Value ≥ Spec. Max. Value x 2.5
Cosmetic Appearance	-	-	Occurrence of notable decoloration, deformation and cracking

Special Notice to Customers Using the Products and Technical Information Shown in This Data Sheet

- 1) The technical information shown in the data sheets are limited to the typical characteristics and circuit examples of the referenced products. It does not constitute the warranting of industrial property nor the granting of any license.
- 2) For the purpose of product improvement, the specifications, characteristics and technical data described in the data sheets are subject to change without prior notice. Therefore it is recommended that the most updated specifications be used in your design.
- 3) When using the products described in the data sheets, please adhere to the maximum ratings for operating voltage, heat dissipation characteristics, and other precautions for use. We are not responsible for any damage which may occur if these specifications are exceeded.
- 4) The products that have been described to this catalog are manufactured so that they will be used for the electrical instrument of the benchmark (OA equipment, telecommunications equipment, AV machine, home appliance and measuring instrument).
The application of aircrafts, space borne application, transportation equipment, medical equipment and nuclear power control equipment, etc. needs a high reliability and safety, and the breakdown and the wrong operation might influence the life or the human body. Please consult us beforehand if you plan to use our product for the usages of aircrafts, space borne application, transportation equipment, medical equipment and nuclear power control equipment, etc. except OA equipment, telecommunications equipment, AV machine, home appliance and measuring instrument.
- 5) In order to export the products or technologies described in this data sheet which are under the "Foreign Exchange and Foreign Trade Control Law," it is necessary to first obtain an export permit from the Japanese government.
- 6) No part of this data sheet may be reprinted or reproduced without prior written permission from Stanley Electric Co., Ltd.
- 7) The most updated edition of this data sheet can be obtained from the address below:
<http://www.stanley-components.com>