



Chipsmall Limited consists of a professional team with an average of over 10 year of expertise in the distribution of electronic components. Based in Hongkong, we have already established firm and mutual-benefit business relationships with customers from,Europe,America and south Asia,supplying obsolete and hard-to-find components to meet their specific needs.

With the principle of "Quality Parts,Customers Priority,Honest Operation,and Considerate Service",our business mainly focus on the distribution of electronic components. Line cards we deal with include Microchip,ALPS,ROHM,Xilinx,Pulse,ON,Everlight and Freescale. Main products comprise IC,Modules,Potentiometer,IC Socket,Relay,Connector.Our parts cover such applications as commercial,industrial, and automotives areas.

We are looking forward to setting up business relationship with you and hope to provide you with the best service and solution. Let us make a better world for our industry!



Contact us

Tel: +86-755-8981 8866 Fax: +86-755-8427 6832

Email & Skype: info@chipsmall.com Web: www.chipsmall.com

Address: A1208, Overseas Decoration Building, #122 Zhenhua RD., Futian, Shenzhen, China



32-Channel Serial to Parallel Converter With High Voltage Push-Pull Outputs

Features

- ▶ Processed with HVCMOS® technology
- ▶ Low power level shifting
- ▶ Shift register speed 8.0MHz
- ▶ Latched data outputs
- ▶ 5.0V CMOS compatible inputs
- ▶ Forward and reverse shifting options
- ▶ Diode to V_{PP} allows efficient power recovery

General Description

The HV9408 is a low voltage serial to high voltage parallel converters with push-pull outputs. This device has been designed for use as a driver for AC-electroluminescent displays. It can also be used in any application requiring multiple output, high voltage current sourcing and sinking capabilities such as driving plasma panels, vacuum fluorescent, or large matrix LCD displays.

These devices consist of a 32-bit shift register, 32 latches, and control logic to enable outputs. HV_{OUT1} is connected to the first stage of the shift register through the Output Enable logic. Data is shifted through the shift register on the low to high transition of the clock. The HV9408 shifts in the counter-clockwise direction when viewed from the top of the package. A data output buffer is provided for cascading devices. This output reflects the current status of the last bit of the shift register (32). Operation of the shift register is not affected by the LE (latch enable) or the OE (output enable) inputs. Transfer of data from the shift register to the latch occurs when the LE input is high. The data in the latch is retained when LE is low.

Block Diagram

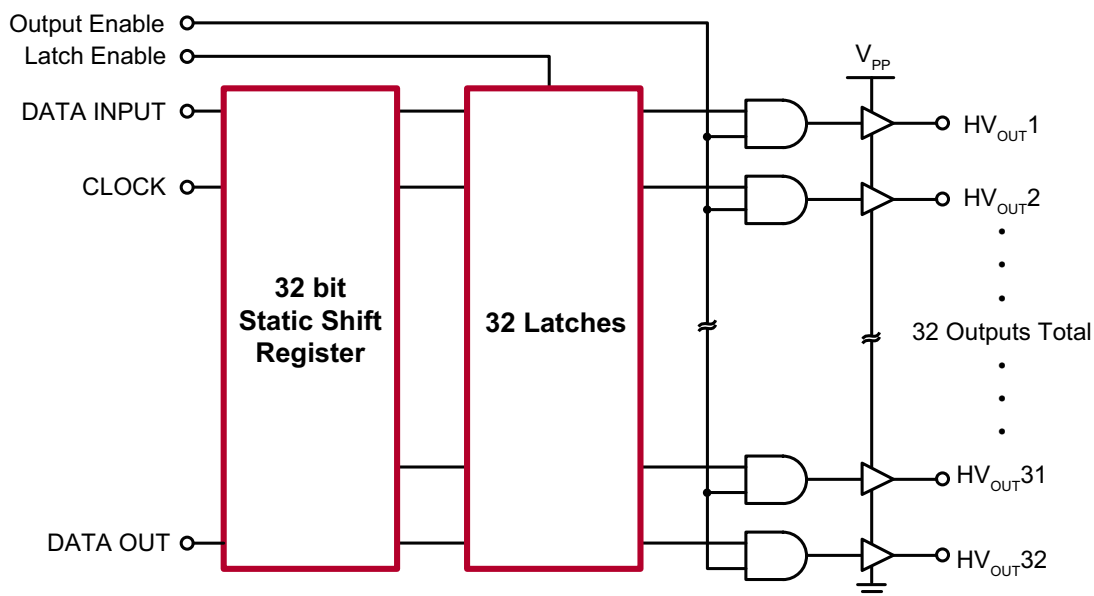

Ordering Information

Device	Package Options
	44-Lead Quad Plastic Chip Carrier .653x.653in body .180in height (max) .050in pitch
HV9408	HV9408PJ-G

-G indicates package is RoHS compliant ('Green')



Pin Configurations

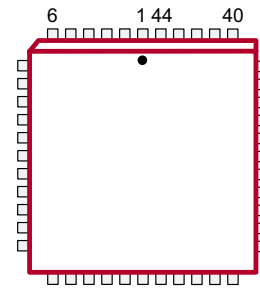

44-Lead Quad Plastic Chip Carrier (PJ)

Product Marking

Top Marking

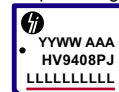

YY = Year Sealed
 WW = Week Sealed
 L = Lot Number
 A = Assembler ID
 C = Country of Origin*
 — = "Green" Packaging
 *May be part of top marking

Bottom Marking

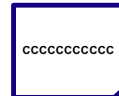

Package may or may not include the following marks: Si or

44-Lead Quad Plastic Chip Carrier (PJ)

Absolute Maximum Ratings

Parameter	Value
Supply voltage, V_{DD}	-0.5V to +7.0V
Supply voltage, V_{PP}	-0.5V to +90V
Logic input levels	-0.5V to V_{DD} +0.5V
Ground current ¹	1.5A
Continuous total power dissipation ²	1200W
Operating temperature range	-40 to +85°C
Storage temperature range	-65 to +150°C

Absolute Maximum Ratings are those values beyond which damage to the device may occur. Functional operation under these conditions is not implied. Continuous operation of the device at the absolute rating level may affect device reliability. All voltages are referenced to device ground.

Notes:

- Duty cycle is limited by the total power dissipated in the package.
- For operation above 25°C ambient derate linearly to maximum operating temperature at 20mW/°C.

Recommended Operating Conditions

Sym	Parameter	Min	Max	Units
V_{DD}	Logic voltage supply	4.5	5.5	V
V_{PP}	High voltage supply	8.0	80	V
V_{IH}	Input high voltage	$V_{DD} - 0.5$	V_{DD}	V
V_{IL}	Input low voltage	0	0.5	V
f_{CLK}	Clock frequency	0	8.0	MHz
T_A	Operating free-air temperature	-40	+85	°C

Electrical Characteristics ($V_{PP} = 60V$, $V_{DD} = 5.0V$, $T_A = 25^\circ C$)

DC Characteristics

Sym	Parameter	Min	Max	Units	Conditions
I_{PP}	V_{PP} supply current	-	100	μA	HV _{OUTPUTS} high to low
I_{DDQ}	I_{DD} supply current (quiescent)	-	100	μA	All inputs = V_{DD} or GND
I_{DD}	I_{DD} supply current (operating)	-	15	mA	$V_{DD} = V_{DD} \text{ max}$, $f_{CLK} = 8.0 \text{ MHz}$
V_{OH} (Data)	Shift register output voltage	$V_{DD} - 0.5$	-	V	$I_O = -100\mu A$
V_{OL} (Data)	Shift register output voltage	-	0.5	V	$I_O = 100\mu A$
I_{IH}	Current leakage, any input	-	1.0	μA	Input = V_{DD}
I_{IL}	Current leakage, any input	-	-1.0	μA	Input = GND
V_{OC}	HV output clamp diode voltage	-	-1.5	V	$I_{OC} = -5.0 \text{ mA}$
V_{OH}	HV output when sourcing	52	-	V	$I_{OH} = -20 \text{ mA}$, 0 to $70^\circ C$
V_{OL}	HV output when sinking	-	4.0	V	$I_{OL} = 5.0 \text{ mA}$, 0 to $70^\circ C$

AC Characteristics

Sym	Parameter	Min	Max	Units	Conditions
f_{CLK}	Clock frequency	-	8.0	MHz	---
t_{WL} or t_{WH}	Clock width, high or low	62	-	ns	---
t_{SU}	Setup time before CLK rises	25	-	ns	---
t_H	Hold time after CLK rises	10	-	ns	---
t_{DLH} (Data)	Data output delay after L to H CLK	-	110	ns	CL = 15pF
t_{DHL} (Data)	Data output delay after H to L CLK	-	110	ns	CL = 15pF
t_{DLE}	LE delay after L to H CLK	50	-	ns	---
t_{WLE}	Width of LE pulse	50	-	ns	---
t_{SLE}	LE setup time before L to H CLK	50	-	ns	---
t_{ON}	Delay from LE to HV _{OUT} , L to H	-	500	ns	---
t_{OFF}	Delay from LE to HV _{OUT} , H to L	-	500	ns	---

Power-Up Sequence

1. Connect ground
2. Apply V_{DD}
3. Set all inputs (Data, CLK, Enable, etc.) to a known state
4. Apply V_{PP}

Power-down sequence should be the reverse of the above.

The V_{PP} should not drop below V_{DD} during operations.

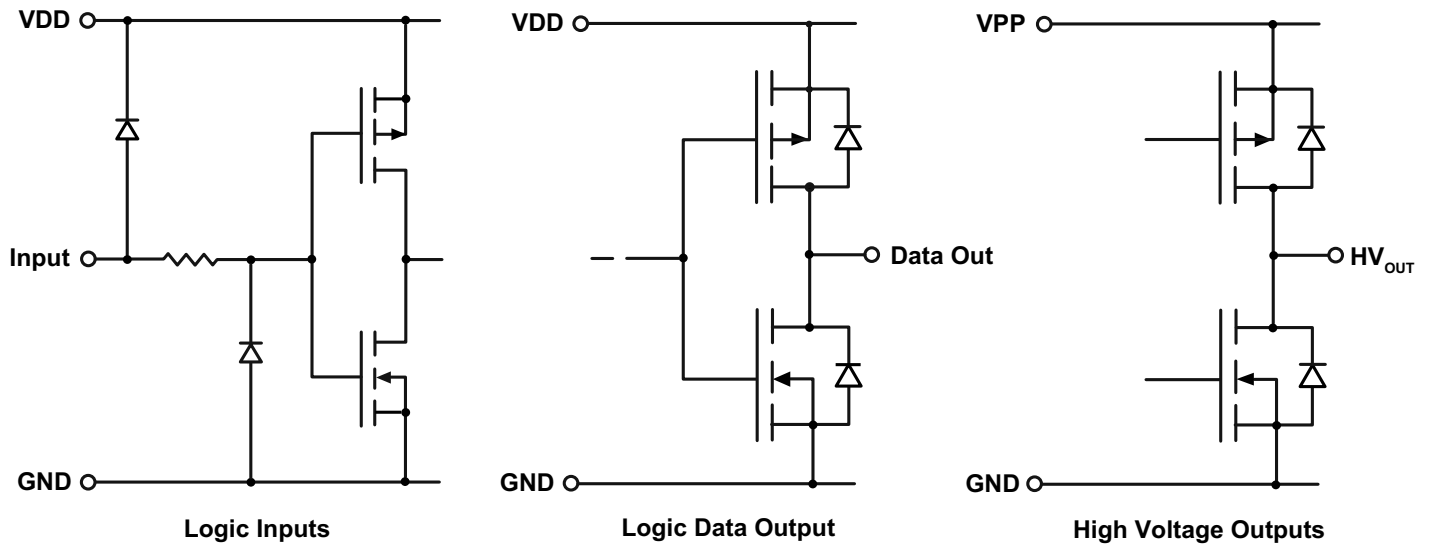

Input and Output Equivalent Circuits

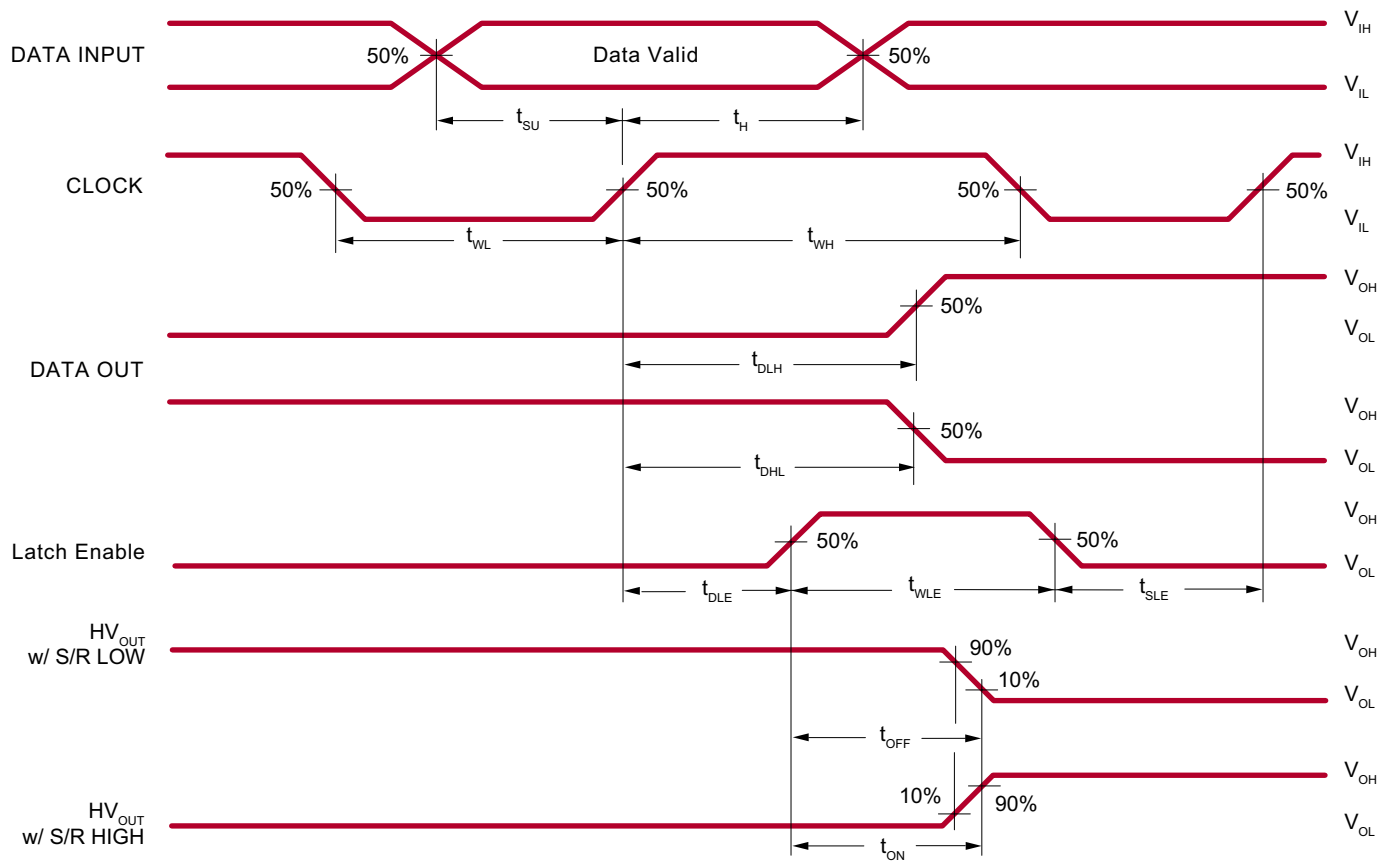

Switching Waveforms



Function Tables

Data Input	CLK	Data Output
H		H
L		L
X	No 	No change

 = low to high level transition.

Data Input	LE	OE	HV Output
X	X	L	All HV _{OUT} = low
X	L	H	Previous latched data
H	H	H	H
L	H	H	L

Pin Description

Pin	Function	Function
1	HV _{OUT} 16	High voltage outputs. High voltage push-pull outputs, which, depending on controlling low voltage data, can drive loads either to a GND, or to V _{PP} rail levels.
2	HV _{OUT} 17	
3	HV _{OUT} 18	
4	HV _{OUT} 19	
5	HV _{OUT} 20	
6	HV _{OUT} 21	
7	HV _{OUT} 22	
8	HV _{OUT} 23	
9	HV _{OUT} 24	
10	HV _{OUT} 25	
11	HV _{OUT} 26	
12	HV _{OUT} 27	
13	HV _{OUT} 28	
14	HV _{OUT} 29	
15	HV _{OUT} 30	
16	HV _{OUT} 31	
17	HV _{OUT} 32	
18	Data Out	Serial data output Data output for cascading to the data input of the next device.
19	N/C	No connect.
20	N/C	
21	N/C	
22	CLK	Data shift register clock. Input are shifted into the shift register on the positive edge of the clock.
23	GND	Logic and high voltage ground.
24	VPP	High voltage power rail.
25	VDD	Low voltage logic power rail.

Pin	Function	Function
26	Latch Enable	Latch enable input. When LE is high, shift register data is transferred into a data latch. When LE is low, data is latched, and new data can be clocked into the shift register.
27	Data In	Serial data input. Data needs to be present before each rising edge of the clock.
28	Output Enable	Output enable input. When OE is low, all HV outputs are forced into a low state, regardless of data in each channel. When OE is high, all HV outputs reflect data latched.
29	N/C	No connect.
30	HV _{OUT1}	High voltage outputs. High voltage push-pull outputs, which, depending on controlling low voltage data, can drive loads either to a GND, or to V _{pp} rail levels.
31	HV _{OUT2}	
32	HV _{OUT3}	
33	HV _{OUT4}	
34	HV _{OUT5}	
35	HV _{OUT6}	
36	HV _{OUT7}	
37	HV _{OUT8}	
38	HV _{OUT9}	
39	HV _{OUT10}	
40	HV _{OUT11}	
41	HV _{OUT12}	
42	HV _{OUT13}	
43	HV _{OUT14}	
44	HV _{OUT15}	

44-Lead PLCC Package Outline (PJ)

.653x.653in body, .180in height (max), .050in pitch

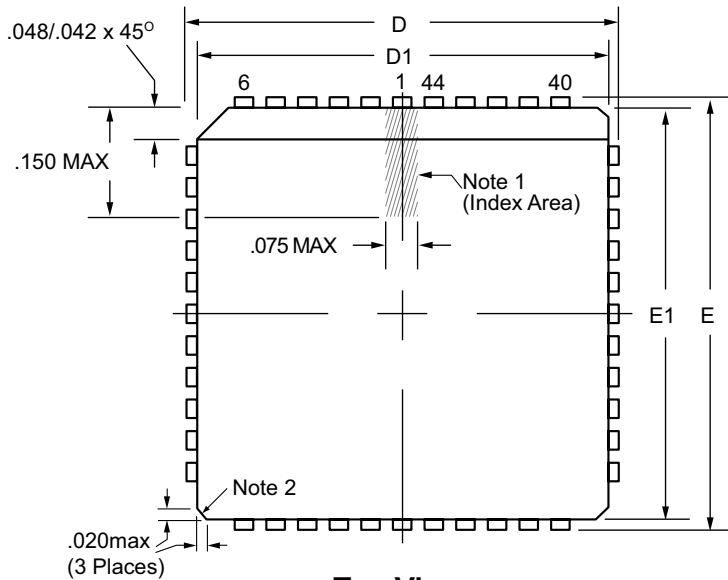

Top View

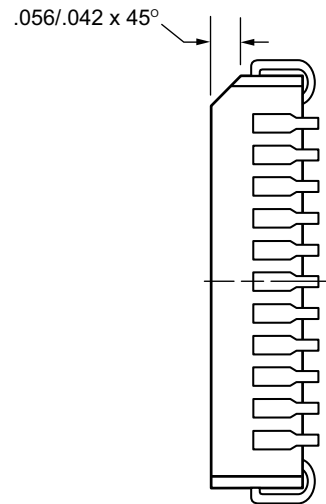

Vertical Side View

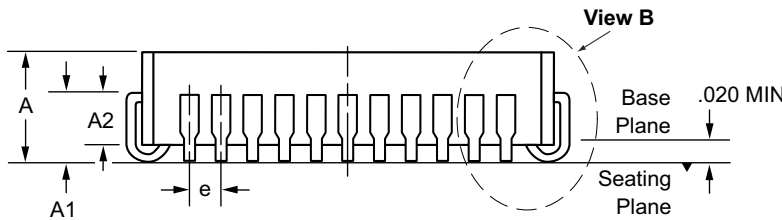

Horizontal Side View

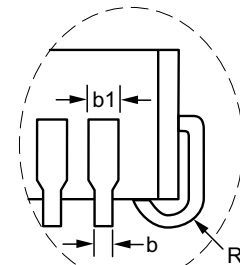

View B

Notes:

1. A Pin 1 identifier must be located in the index area indicated. The Pin 1 identifier can be: a molded mark/identifier; an embedded metal marker; or a printed indicator.
2. Actual shape of this feature may vary.

Symbol	A	A1	A2	b	b1	D	D1	E	E1	e	R	
Dimension (inches)	MIN	.165	.090	.062	.013	.026	.685	.650	.685	.650	.050 BSC	.025
	NOM	.172	.105	-	-	-	.690	.653	.690	.653		.035
	MAX	.180	.120	.083	.021	.036 [†]	.695	.656	.695	.656		.045

JEDEC Registration MS-018, Variation AC, Issue A, June, 1993.

[†] This dimension differs from the JEDEC drawing.

Drawings not to scale.

Supertex Doc. #: DSPD-44PLCCPJ, Version F031111.

(The package drawing(s) in this data sheet may not reflect the most current specifications. For the latest package outline information go to <http://www.supertex.com/packaging.html>.)

Supertex inc. does not recommend the use of its products in life support applications, and will not knowingly sell them for use in such applications unless it receives an adequate "product liability indemnification insurance agreement." **Supertex inc.** does not assume responsibility for use of devices described, and limits its liability to the replacement of the devices determined defective due to workmanship. No responsibility is assumed for possible omissions and inaccuracies. Circuitry and specifications are subject to change without notice. For the latest product specifications refer to the **Supertex inc.** (website: <http://www.supertex.com>)