



Chipsmall Limited consists of a professional team with an average of over 10 year of expertise in the distribution of electronic components. Based in Hongkong, we have already established firm and mutual-benefit business relationships with customers from,Europe,America and south Asia,supplying obsolete and hard-to-find components to meet their specific needs.

With the principle of “Quality Parts,Customers Priority,Honest Operation,and Considerate Service”,our business mainly focus on the distribution of electronic components. Line cards we deal with include Microchip,ALPS,ROHM,Xilinx,Pulse,ON,Everlight and Freescale. Main products comprise IC,Modules,Potentiometer,IC Socket,Relay,Connector.Our parts cover such applications as commercial,industrial, and automotives areas.

We are looking forward to setting up business relationship with you and hope to provide you with the best service and solution. Let us make a better world for our industry!



Contact us

Tel: +86-755-8981 8866 Fax: +86-755-8427 6832

Email & Skype: info@chipsmall.com Web: www.chipsmall.com

Address: A1208, Overseas Decoration Building, #122 Zhenhua RD., Futian, Shenzhen, China



HW-102A

標準はテーピングリール供給となります。
(6,000pcs./Reel)

注意: 弊社製品のご検討にあたっては本カタログの表紙裏の「重要注意事項」を良くお読みください。

Shipped in packet-tape reel(6,000pcs/Reel)

Notice : It is requested to read and accept "IMPORTANT NOTICE" written on the back of the front cover of this catalogue.

●最大定格 Absolute Maximum Ratings

項目 Item	記号 Symbol	条件 Conditions	定格 Limit	単位 Unit
最大制御電流 Max. Input Current	Ic	40°C 定電流駆動 Const. Current Drive	20	mA
動作温度 Operating Temp. Range	Topr		-40 ~ +110	°C
保存温度 Storage Temp. Range	Tstg		-40 ~ +125	°C

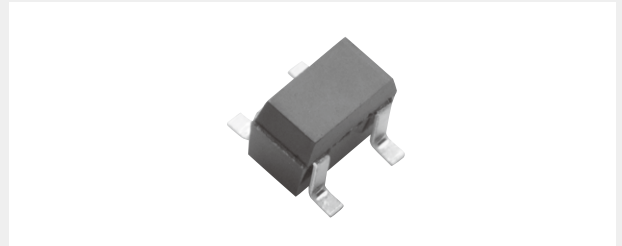

●電気的特性 (測定温度 25°C) Electrical Characteristics (Ta=25°C)

項目 Item	記号 Symbol	測定条件 Conditions	最小 Min.	標準 Typ.	最大 Max.	単位 Unit
ホール出力電圧 Output Hall Voltage	V _H *	定電圧駆動 Const. Voltage Drive B=50mT, V _c =1V	196		370	mV
入力抵抗 Input Resistance	R _{in}	B=0mT, I _c =0.1mA	250		450	Ω
出力抵抗 Output Resistance	R _{out}	B=0mT, I _c =0.1mA	250		450	Ω
不平衡電圧 Offset Voltage	V _{os} (V _u)	B=0mT, V _c =1V	-7		+7	mV
出力電圧の温度係数 Temp. Coefficient of V _H	αV _H *	20°C基準, 0~40°C間の平均 Average on 0~40°C B=50mT, I _c =5mA		-1.8		%/°C
入力抵抗の温度係数 Temp. Coefficient of R _{in}	αR _{in} *	20°C基準, 0~40°C間の平均 Average on 0~40°C B=0mT, I _c =0.1mA		-1.8		%/°C

Notes : 1. V_H = V_HM - V_{os}(V_u) (V_HM: meter indication)

$$2. \alpha V_H = \frac{1}{V_H(T_1)} \times \frac{V_H(T_3) - V_H(T_2)}{(T_3 - T_2)} \times 100$$

$$3. \alpha R_{in} = \frac{1}{R_{in}(T_1)} \times \frac{R_{in}(T_3) - R_{in}(T_2)}{(T_3 - T_2)} \times 100$$

T₁ = 20°C, T₂ = 0°C, T₃ = 40°C

●ホール出力電圧区分とランク表示

Classification of Output Hall Voltage (V_H)

ランク表示 Rank	ホール出力電圧 V _H [mV]	測定条件 Conditions
D	196 ~ 236	定電圧駆動 B=50mT, V _c =1V Constant Voltage Drive
E	228 ~ 274	
F	266 ~ 320	
G	310 ~ 370	

注) ランク幅3ランク以上での設計をお願い致します。

Note : When ordering, specify 3-rank or wider range (e.g. E, F, G).

●最大入力電流 入出力抵抗 250~450 (Ω) 静止気中 Input Current Derating Curve

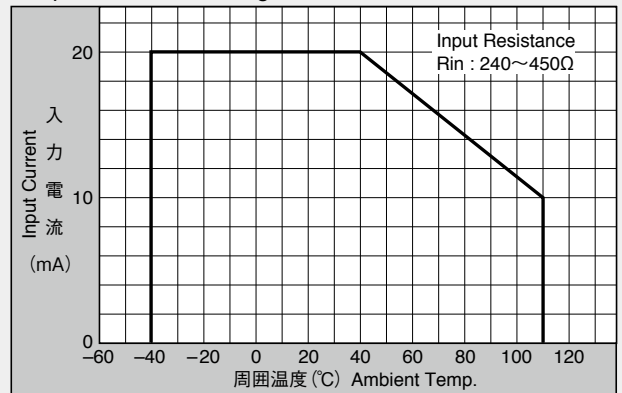

注) ホール素子の入力抵抗は周囲温度の上昇に伴い急速に低下します。使用温度範囲において最大入力電流を超えないように設計してください。

Note : R_{in} of Hall element decreases rapidly as ambient temperature increases. Ensure compliance with input current derating curve envelope, throughout the operating temperature range.

●最大入力電圧 入出力抵抗 250~450 (Ω) 静止気中 Input Voltage Derating Curve

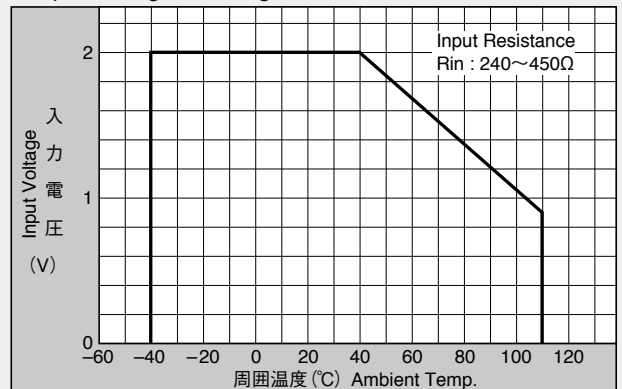

注) 制限抵抗がない場合は、最大入力電圧の範囲以内でご使用ください。

Note : For constant-voltage drive, stay within this input voltage derating curve envelope.

●外形寸法図 Dimensional Drawing (Unit : mm)

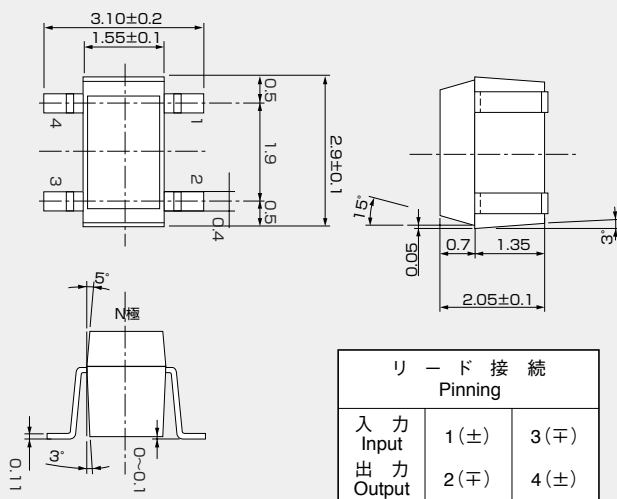

・医療機器、安全装置、航空宇宙用機器、原子力制御用機器など、その装置・機器の故障や動作不良が、直接または間接を問わず、生命、身体、財産等へ重大な損害を及ぼすことが通常予想されるような極めて高い信頼性を要求される用途に弊社製品を使用される場合は、必ず事前に弊社代表取締役の書面による同意をお取りください。

・AKM products are neither intended nor authorized for use as critical components in any safety, life support, or other hazard related device or system, and AKM assumes no responsibility for such use, except for the use approved with the express written consent by Representative Director of AKM.

●特性曲線図 Characteristic Curves

Rin-T

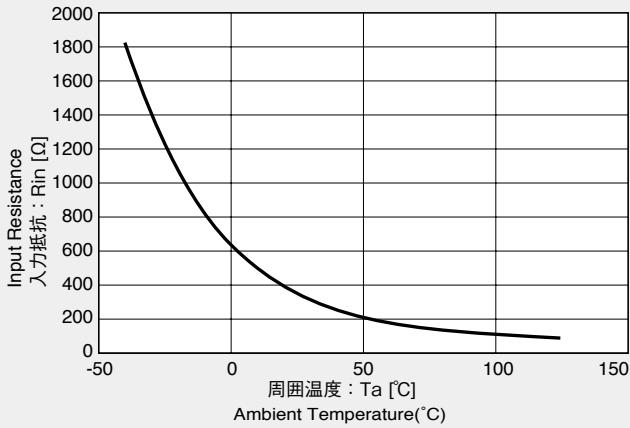

V_H-B

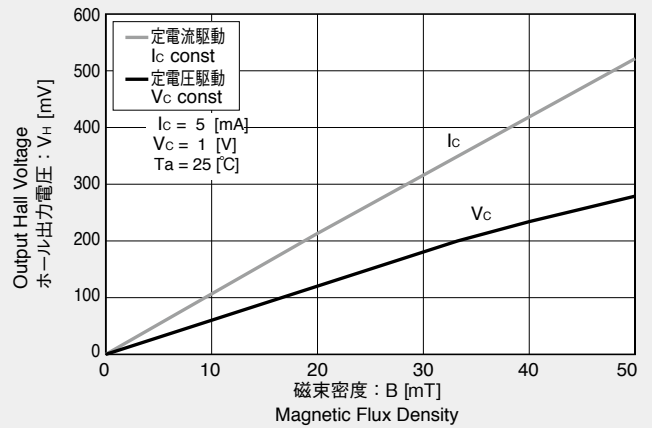

V_H-T

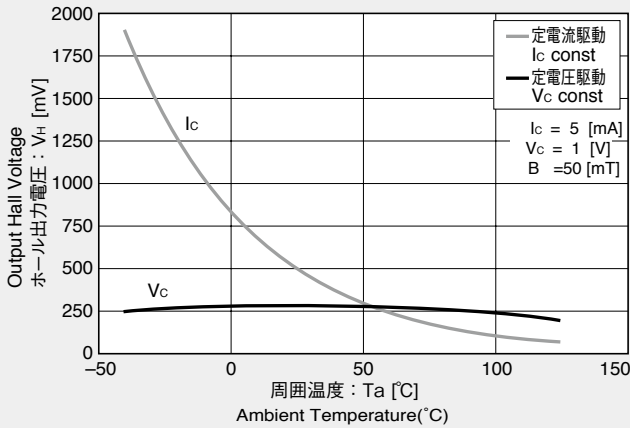

V_H-V_c, V_H-I_c

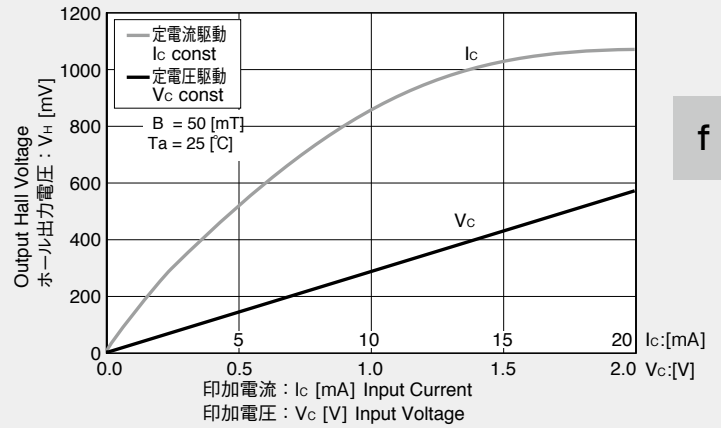

V_{os} (V_u)-T (参考)

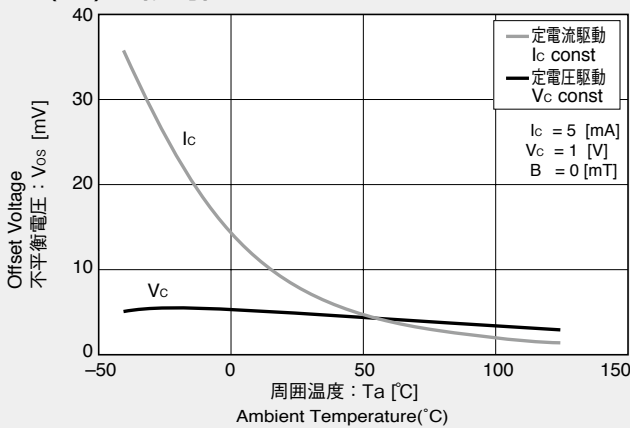

V_{os} (V_u)-V_c, V_{os} (V_u)-I_c (参考)

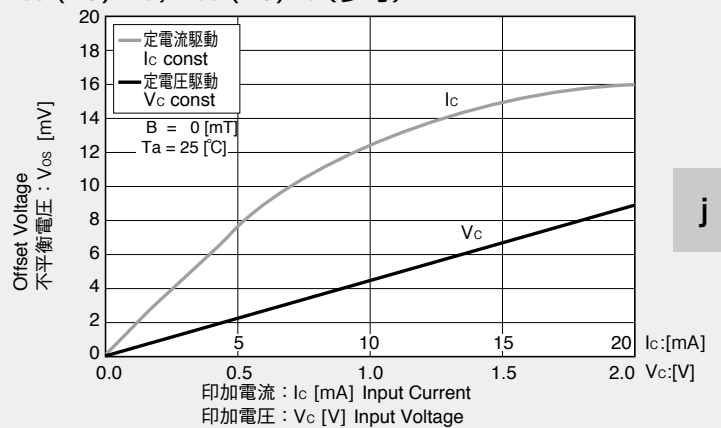

※Magnetic Flux Density
1[mT]=10[G]

定電圧駆動 Rin=350[Ω]、V_{os}=4.7[mV] [V_c=1[V]]の例
定電流駆動 同上素子
In This Example : Rin=350 [Ω] , V_{os}=4.7 [mV] , [V_c=1 [V]]

重要注意事項

- 本書に記載された製品、および、製品の仕様につきましては、製品改善のために予告なく変更することがあります。従いまして、ご使用を検討の際には、本書に掲載した情報が最新のものであることを弊社営業担当、あるいは弊社特約店営業担当にご確認ください。
- 本書に記載された周辺回路、応用回路、ソフトウェアおよびこれらに関連する情報は、半導体製品の動作例、応用例を説明するものです。お客様の機器設計において本書に記載された周辺回路、応用回路、ソフトウェアおよびこれらに関連する情報を使用される場合は、お客様の責任において行ってください。本書に記載された周辺回路、応用回路、ソフトウェアおよびこれらに関連する情報の使用に起因してお客様または第三者に生じた損害に対し、弊社はその責任を負うものではありません。また、当該使用に起因する、工業所有権その他の第三者の所有する権利に対する侵害につきましても同様です。
- 本書記載製品が、外国為替および、外国貿易管理法に定める戦略物資(役務を含む)に該当する場合、輸出する際に同法に基づく輸出許可が必要です。
- 医療機器、安全装置、航空宇宙用機器、原子力制御用機器など、その装置・機器の故障や動作不良が、直接または間接を問わず、生命、身体、財産等へ重大な損害を及ぼすことが通常予想されるような極めて高い信頼性を要求される用途に弊社製品を使用される場合は、必ず事前に弊社代表取締役の書面による同意をお取りください。
- この同意書を得ずにこうした用途に弊社製品を使用した場合、弊社は、その使用から生ずる損害等の責任を一切負うものではありませんのでご了承ください。
- お客様の転売等によりこの注意事項の存在を知らずに上記用途に弊社製品が使用され、その使用から損害等が生じた場合は全てお客様にてご負担または補償して頂きますのでご了承ください。

2015年4月1日現在

IMPORTANT NOTICE

- These products and their specifications are subject to change without notice. When you consider any use or application of these products, please make inquiries the sales office of Asahi Kasei Microdevices Corporation (AKM) or authorized distributors as to current status of the products.
- Descriptions of external circuits, application circuits, software and other related information contained in this document are provided only to illustrate the operation and application examples of the semiconductor products. You are fully responsible for the incorporation of these external circuits, application circuits, software and other related information in the design of your equipments. AKM assumes no responsibility for any losses incurred by you or third parties arising from the use of these information herein. AKM assumes no liability for infringement of any patent, intellectual property, or other rights in the application or use of such information contained herein.
- Any export of these products, or devices or systems containing them, may require an export license or other official approval under the law and regulations of the country of export pertaining to customs and tariffs, currency exchange, or strategic materials.
- AKM products are neither intended nor authorized for use as critical components>Note1) in any safety, life support, or other hazard related device or system>Note2), and AKM assumes no responsibility for such use, except for the use approved with the express written consent by Representative Director of AKM. As used here:
Note1) A critical component is one whose failure to function or perform may reasonably be expected to result, whether directly or indirectly, in the loss of the safety or effectiveness of the device or system containing it, and which must therefore meet very high standards of performance and reliability.
Note2) A hazard related device or system is one designed or intended for life support or maintenance of safety or for applications in medicine, aerospace, nuclear energy, or other fields, in which its failure to function or perform may reasonably be expected to result in loss of life or in significant injury or damage to person or property.
- It is the responsibility of the buyer or distributor of AKM products, whodistributes, disposes of, or otherwise places the product with a third party, to notify such third party in advance of the above content and conditions, and the buyer or distributor agrees to assume any and all responsibility and liability for and hold AKM harmless from any and all claims arising from the use of said product in the absence of such notification.

April 1, 2015