



Chipsmall Limited consists of a professional team with an average of over 10 year of expertise in the distribution of electronic components. Based in Hongkong, we have already established firm and mutual-benefit business relationships with customers from,Europe,America and south Asia,supplying obsolete and hard-to-find components to meet their specific needs.

With the principle of “Quality Parts,Customers Priority,Honest Operation,and Considerate Service”,our business mainly focus on the distribution of electronic components. Line cards we deal with include Microchip,ALPS,ROHM,Xilinx,Pulse,ON,Everlight and Freescale. Main products comprise IC,Modules,Potentiometer,IC Socket,Relay,Connector.Our parts cover such applications as commercial,industrial, and automotives areas.

We are looking forward to setting up business relationship with you and hope to provide you with the best service and solution. Let us make a better world for our industry!



Contact us

Tel: +86-755-8981 8866 Fax: +86-755-8427 6832

Email & Skype: info@chipsmall.com Web: www.chipsmall.com

Address: A1208, Overseas Decoration Building, #122 Zhenhua RD., Futian, Shenzhen, China



NOTES:

1. ROHS COMPLIANT
2. HEADER: THERMOSET PLASTIC MATERIAL WITH FLAMMABILITY RATING UL 94V-0 OR BETTER.
3. STORAGE TEMPERATURE: -50°C TO +125°C
4. COMPLIANCE TO J-STD:
 - A. J-STD-002: SOLDERABILITY AT 245°C REFLOW PROFILE
 - B. J-STD-020: LEVEL 1, NO MOISTURE SENSITIVE
 - C. J-STD-075: R7, 245°C MAXIMUM THROUGH REFLOW SOLDER
5. TO ORDER TAPE & REEL PACKAGING ADD A "T" SUFFIX TO THE PART NUMBER(i.e HX1188NL BECOMES HX1188NLT).

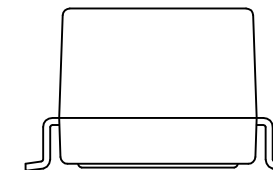
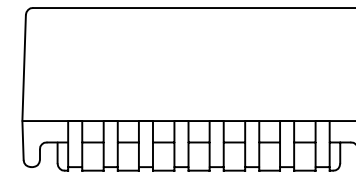
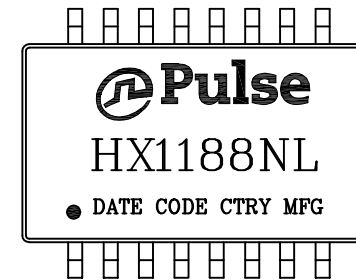

FINAL OUTLINE

© Copyright, 2015. Pulse Electronics Corp. All rights reserved. Pulse confidential & proprietary. (07/30/15)

PRODUCT DESCRIPTION	TLA DRAWING	PS DRAWING	SHEET	PART NO.	DATASHEET REV.
MDL,SIN,100D,1:1,SMT	HX1188NL-13	PS-2005.001-F	1 OF 3	HX1188NL	A

ELECTRICAL CHARACTERISTICS AT +25°C UNLESS OTHER SPECIFIED
MEETS IEEE 802.3 SPECIFICATION

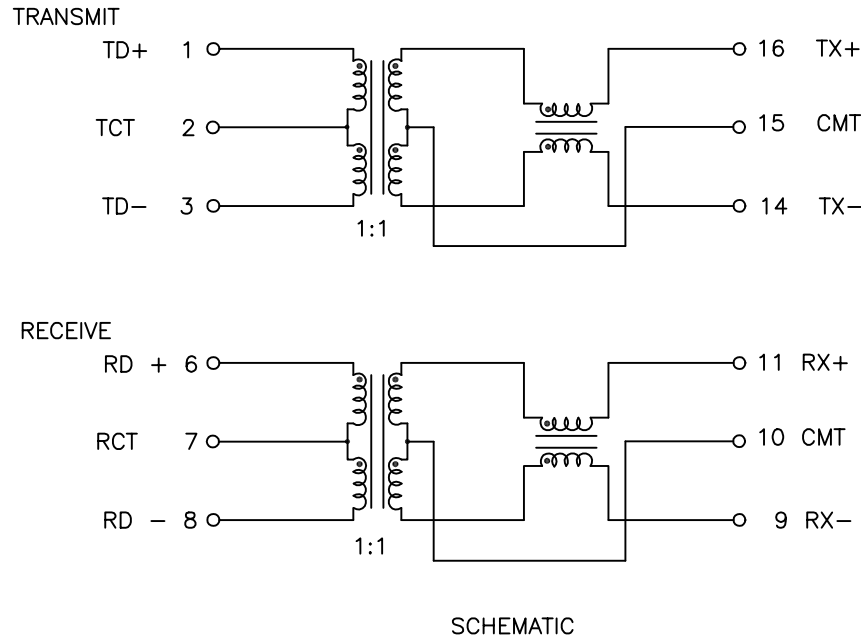

PARAMETER	SPECIFICATIONS	
OPERATING TEMP	-40°C ~ +85°C	
URNS RATIO	1.00 ± 2%	
POLARITY	PER SCHEMATIC	
INDUCTANCE (OCL) (MEDIA SIDE, -40 ~ +85°C)	350 uH MIN (MEASURED AT 100 KHz, 100 mVRMS) (AND WITH 8 mA DC BIAS)	
	440 uH MIN AT +25°C	
DC RESISTANCE	1-3, 16-14, 6-8, 11-9 = 1.50 OHMS MAXIMUM	
LEAKAGE INDUCTANCE 100 KHz, 100 mV	(1-3) WITH (16-14) SHORTED=0.3uH MAX (6-8) WITH (11-9) SHORTED=0.3uH MAX	
INSERTION LOSS	1-100 MHz	125 MHz
	-1.0 dB MAX	-3.0 dB MAX
RETURN LOSS Z _{OUT} = 100 OHMS	5 MHz	30-80 MHz
	-18 dB MIN	-16 + 26LOG ₁₀ (f/30 MHz) dB MIN
CROSSTALK (TX-RX)	1 MHz	5-100 MHz
	-62 dB MIN	-45 + 21LOG ₁₀ (f/30 MHz) dB MIN
DIFFERENTIAL TO COMMON MODE REJECTION	5-200 MHz	
	-50 + 17LOG ₁₀ (f/5 MHz) dB MIN	
ISOLATION (INPUT - OUTPUT)	VOLTAGE	TIME
	1650 VRMS	6 SECONDS MAX

NOTE: f IS FREQUENCY IN MHz.

© Copyright, 2015. Pulse Electronics Corp. All rights reserved. Pulse confidential & proprietary. (07/30/15)

PRODUCT DESCRIPTION	TLA DRAWING	PS DRAWING	SHEET	PART NO.	DATASHEET REV.
MDL,SIN,100D,1:1,SMT	HX1188NL-13	PS-2005.001-F	2 OF 3	HX1188NL	A

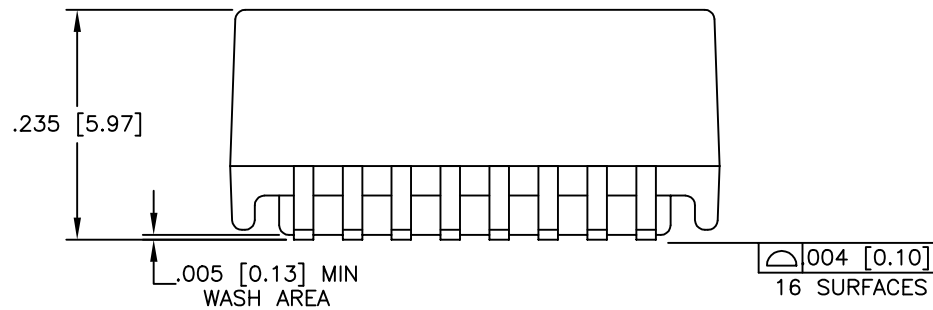
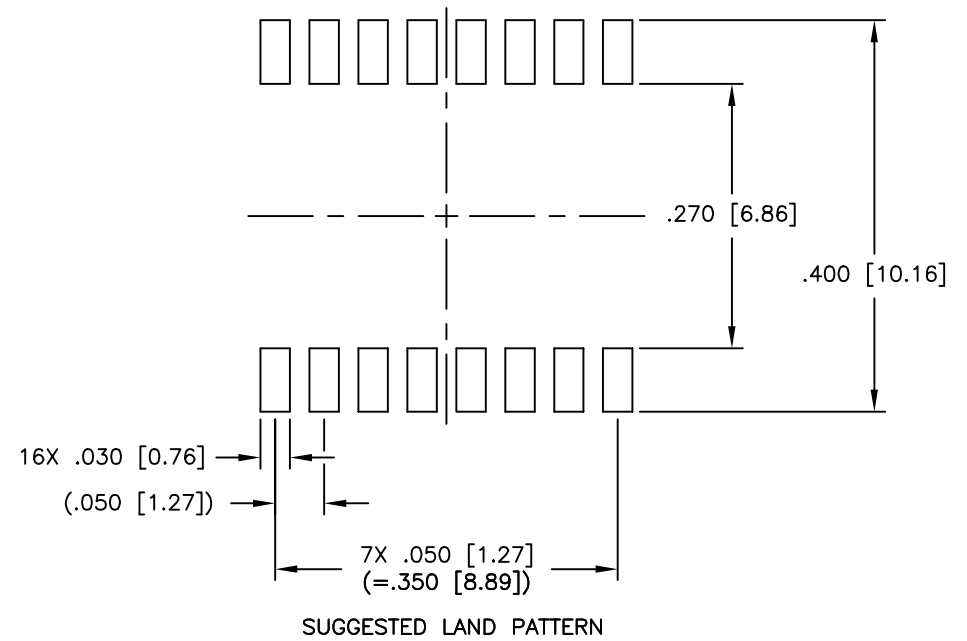
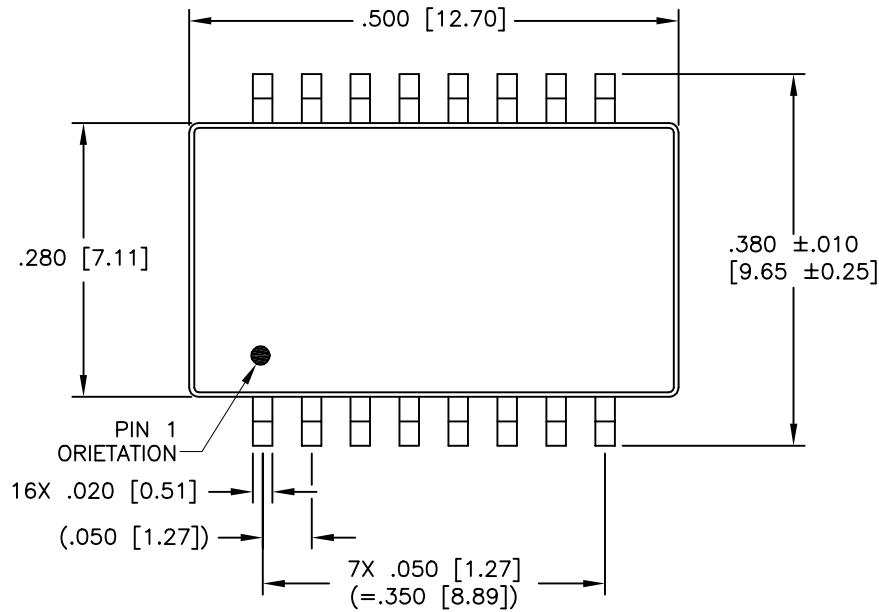

DIMENSIONS ARE IN INCHES [MILLIMETERS] WITH THE FOLLOWING TOLERANCES: [MILLIMETERS] ARE FOR REFERENCE ONLY.
.XX= ±.01 [±0.25]
.XXX= ±.005 [±0.13]

© Copyright, 2015. Pulse Electronics Corp. All rights reserved. Pulse confidential & proprietary. (07/30/15)

PRODUCT DESCRIPTION	TLA DRAWING	PS DRAWING	SHEET	PART NO.	DATASHEET REV.
MDL,SIN,100D,1:1,SMT	HX1188NL-13	PS-2005.001-F	3 OF 3	HX1188NL	A