



Chipsmall Limited consists of a professional team with an average of over 10 year of expertise in the distribution of electronic components. Based in Hongkong, we have already established firm and mutual-benefit business relationships with customers from,Europe,America and south Asia,supplying obsolete and hard-to-find components to meet their specific needs.

With the principle of “Quality Parts,Customers Priority,Honest Operation,and Considerate Service”,our business mainly focus on the distribution of electronic components. Line cards we deal with include Microchip,ALPS,ROHM,Xilinx,Pulse,ON,Everlight and Freescale. Main products comprise IC,Modules,Potentiometer,IC Socket,Relay,Connector.Our parts cover such applications as commercial,industrial, and automotives areas.

We are looking forward to setting up business relationship with you and hope to provide you with the best service and solution. Let us make a better world for our industry!



## Contact us

Tel: +86-755-8981 8866 Fax: +86-755-8427 6832

Email & Skype: info@chipsmall.com Web: www.chipsmall.com

Address: A1208, Overseas Decoration Building, #122 Zhenhua RD., Futian, Shenzhen, China



# 6<sup>th</sup> Generation CoolSiC™

## 650V SiC Schottky Diode

The CoolSiC™ generation 6 (G6) is the leading edge technology from Infineon for the SiC Schottky barrier diodes. The Infineon proprietary innovative G5 technology was enhanced in G6 by introducing further advancements like a novel Schottky metal system. The result is a family of products with improved efficiency over all load conditions, resulting from a lower figure of merit ( $Q_C \times V_F$ ). The CoolSiC™ Schottky diode 650 V G6 has been designed to complement our 600 V and 650 V CoolMOS™ 7 families, meeting the most stringent application requirements in this voltage range.

**Table 1** Key performance parameters

Parameter	Value	Unit
$V_{RRM}$	650	V
$Q_C (V_R = 400 \text{ V})$	12.2	nC
$E_C (V_R = 400 \text{ V})$	2.2	μJ
$I_F (T_C \leq 145 \text{ °C}, D = 1)$	8	A
$V_F (I_F = 8 \text{ A}, T_j = 25 \text{ °C})$	1.25	V

**Table 2** Package information

Type / ordering Code	Package	Marking
IDH08G65C6	PG-TO220-2	D0865C6

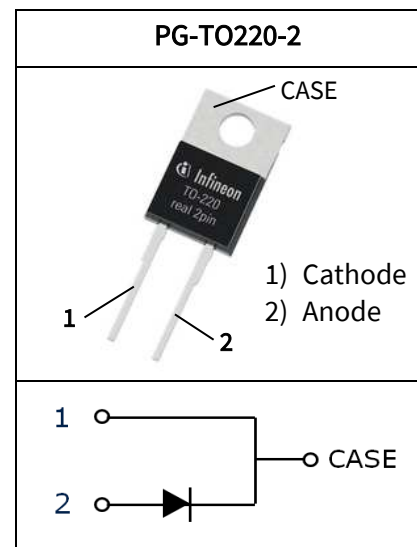

### Features

- Best in class forward voltage (1.25 V)
- Best in class figure of merit ( $Q_C \times V_F$ )
- High dv/dt ruggedness (150 V/ns)

### Benefits

- System efficiency improvement
- System cost and size savings due to the reduced cooling requirements
- Enabling higher frequency and increased power density

### Potential Applications

- Power factor correction in SMPS
- Solar inverter
- Uninterruptible power supply

### Product Validation

- Qualified for industrial applications according to the relevant tests of JEDEC (J-STD20 and JESD22)



## Table of Content

1	Maximum ratings .....	3
2	Thermal characteristics .....	3
3	Electrical characteristics .....	4
3.1	Static characteristics .....	4
3.2	AC characteristics .....	4
4	Diagrams .....	5
5	Simplified forward characteristic .....	7
6	Package outlines .....	8

## 1 Maximum ratings

Table 3 Maximum ratings

Parameter	Symbol	Values			Unit	Note/Test condition
		Min.	Typ.	Max.		
Continuous forward current	$I_F$	-	-	8	A	$T_C \leq 145\text{ °C}, D = 1$
		-	-	11		$T_C \leq 125\text{ °C}, D = 1$
		-	-	20		$T_C \leq 25\text{ °C}, D = 1$
Surge-repetitive forward current, sine halfwave <sup>1</sup>	$I_{F,RM}$	-	-	35		$T_C = 25\text{ °C}, t_p = 10\text{ ms}$
Surge non-repetitive forward current, sine halfwave	$I_{F,SM}$	-	-	47		$T_C = 25\text{ °C}, t_p = 10\text{ ms}$
		-	-	37		$T_C = 150\text{ °C}, t_p = 10\text{ ms}$
Non-repetitive peak forward current	$I_{F,max}$	-	-	530	$T_C = 25\text{ °C}, t_p = 10\text{ }\mu\text{s}$	
$i^2t$ value	$\int i^2 dt$	-	-	11	A <sup>2</sup> s	$T_C = 25\text{ °C}, t_p = 10\text{ ms}$
		-	-	6.9		$T_C = 150\text{ °C}, t_p = 10\text{ ms}$
Repetitive peak reverse voltage	$V_{RRM}$	-	-	650	V	$T_C = 25\text{ °C}$
Diode dv/dt ruggedness	$dv/dt$	-	-	150	V/ns	$V_R = 0..480\text{ V}$
Power dissipation	$P_{tot}$	-	-	63	W	$T_C = 25\text{ °C}, R_{thJC,max}$
Operating and storage temperature	$T_j$	-55	-	175	°C	-
	$T_{stg}$					
Mounting torque	-	-	-	70	Ncm	M3 screw

## 2 Thermal characteristics

Table 4 Thermal characteristics (PG-TO-220-2)

Parameter	Symbol	Values			Unit	Note/Test condition
		Min.	Typ.	Max.		
Thermal resistance, junction-case	$R_{thJC}$	-	1.4	2.4	K/W	-
Thermal resistance, junction-ambient	$R_{thJA}$	-	-	62		leaded
Soldering temperature, wavesoldering only allowed at leads	$T_{sold}$	-	-	260	°C	1.6 mm (0.063 in.) from case for 10 s

<sup>1</sup> The surge-repetitive forward current test was performed with 1000 pulses (half-wave rectified sine with the 10 ms period).

### 3 Electrical characteristics

#### 3.1 Static characteristics

Table 5 Static characteristics

Parameter	Symbol	Values			Unit	Note/Test condition
		Min.	Typ.	Max.		
DC blocking voltage	$V_{DC}$	650	–	–	V	$T_j = 25\text{ °C}$
Diode forward voltage	$V_F$	–	1.25	1.35		$I_F = 8\text{ A}, T_j = 25\text{ °C}$
		–	1.5	–		$I_F = 8\text{ A}, T_j = 150\text{ °C}$
Reverse current	$I_R$	–	0.8	27	$\mu\text{A}$	$V_R = 420\text{ V}, T_j = 25\text{ °C}$
		–	27	–		$V_R = 420\text{ V}, T_j = 125\text{ °C}$
		–	62	–		$V_R = 420\text{ V}, T_j = 150\text{ °C}$

#### 3.2 AC characteristics

Table 6 AC characteristics

Parameter	Symbol	Values			Unit	Note/Test Condition
		Min.	Typ.	Max.		
Total capacitive charge	$Q_C$	–	12.2	–	nC	$V_R = 400\text{ V}, T_j = 150\text{ °C},$ $di/dt = 200\text{ A}/\mu\text{s}, I_F \leq I_{F,MAX}$
Total capacitance	C	–	401	–	pF	$V_R = 1\text{ V}, f = 1\text{ MHz},$ $T_j = 25\text{ °C}$
		–	24	–		$V_R = 300\text{ V}, f = 1\text{ MHz},$ $T_j = 25\text{ °C}$
		–	23	–		$V_R = 600\text{ V}, f = 1\text{ MHz},$ $T_j = 25\text{ °C}$

## 4 Diagrams

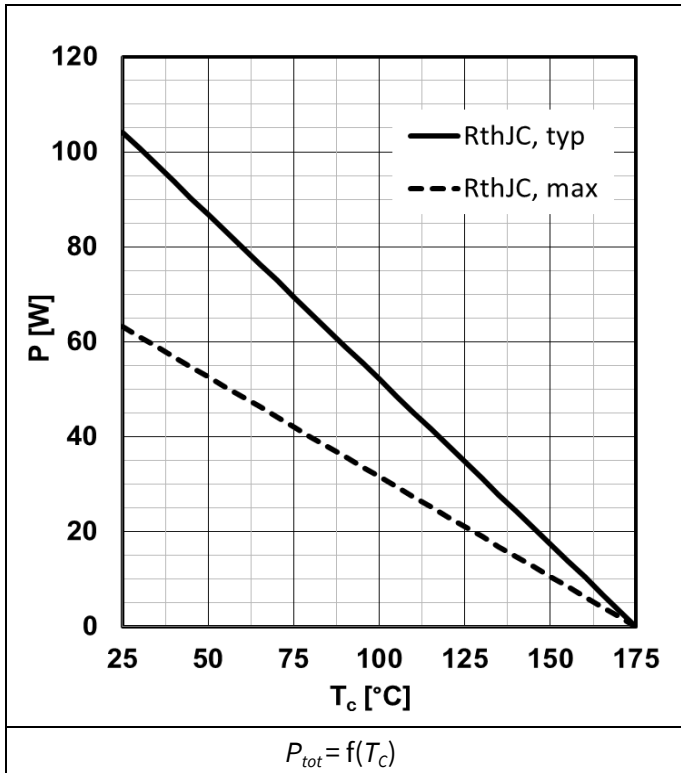

Figure 1 Power dissipation

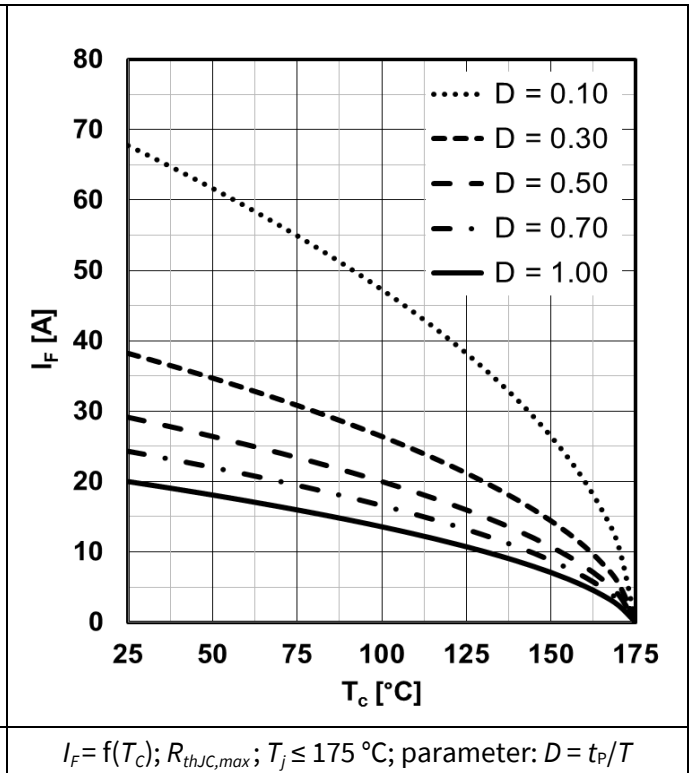

Figure 2 Max. forward current

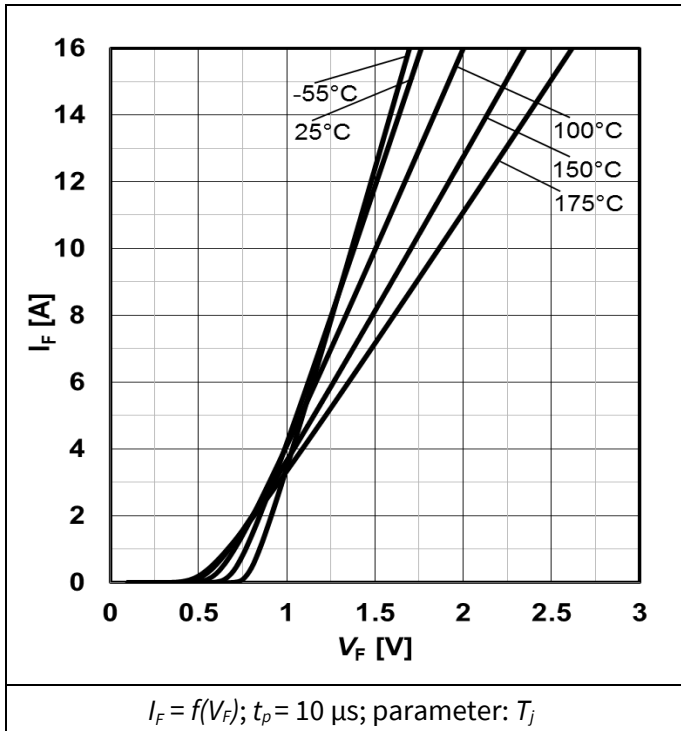

Figure 3 Typ. forward characteristics

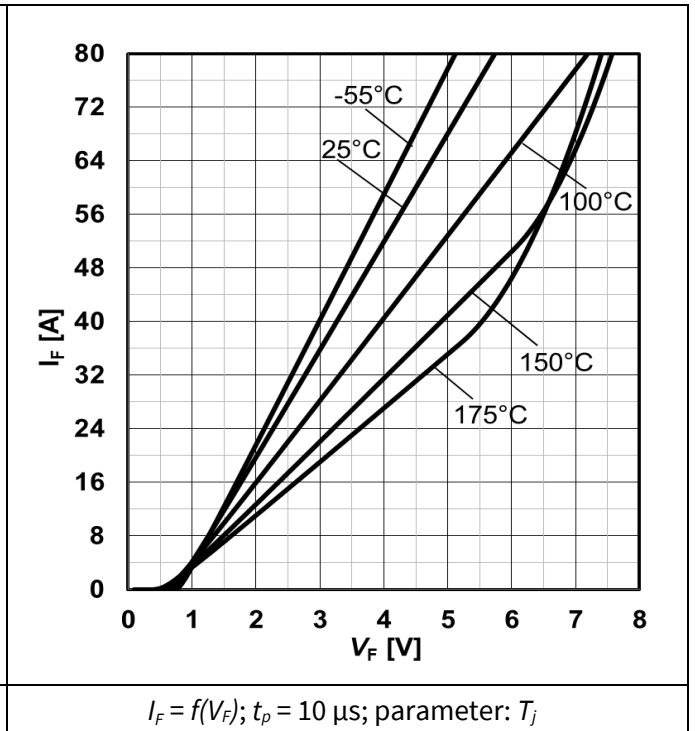

Figure 4 Typ. forward characteristics in surge current

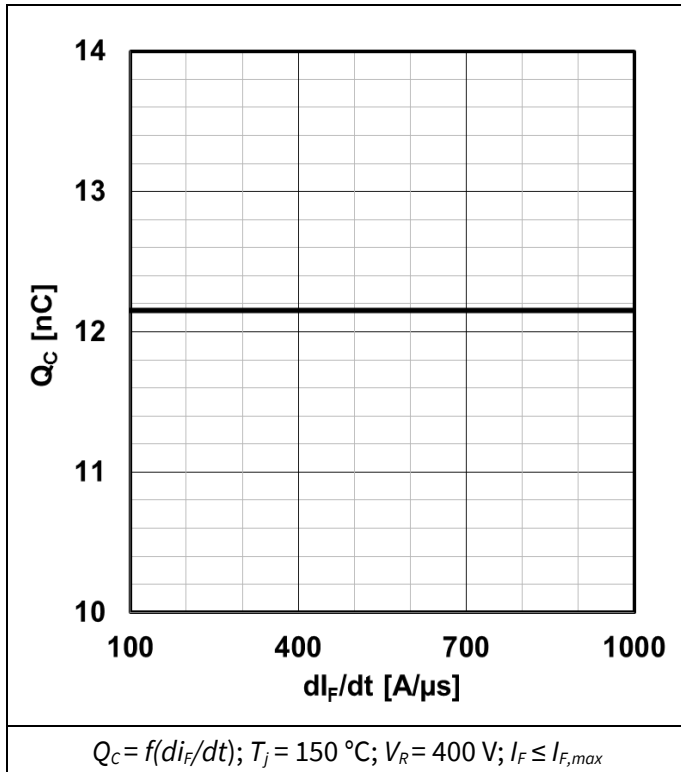

Figure 5 Typ. cap. charge vs. current slope

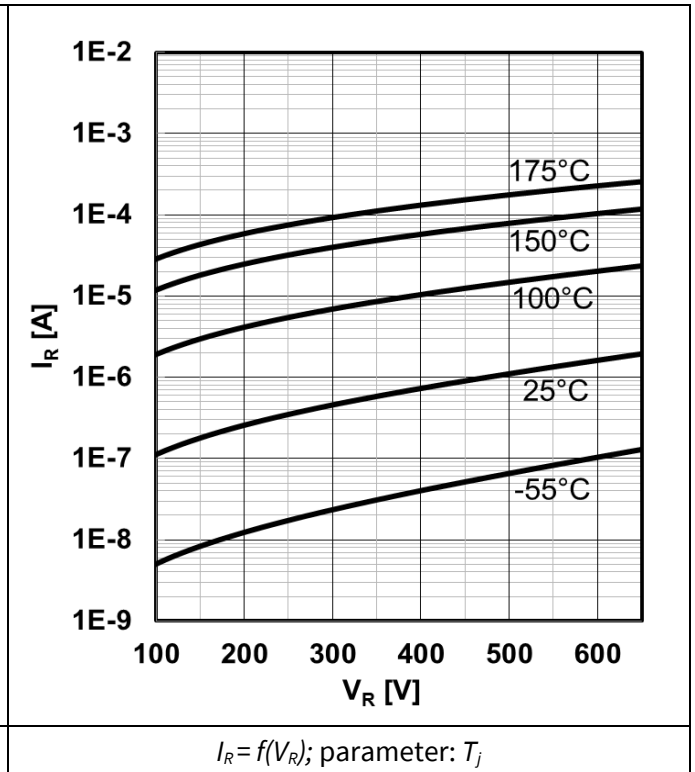

Figure 6 Typ. reverse current vs. reverse voltage

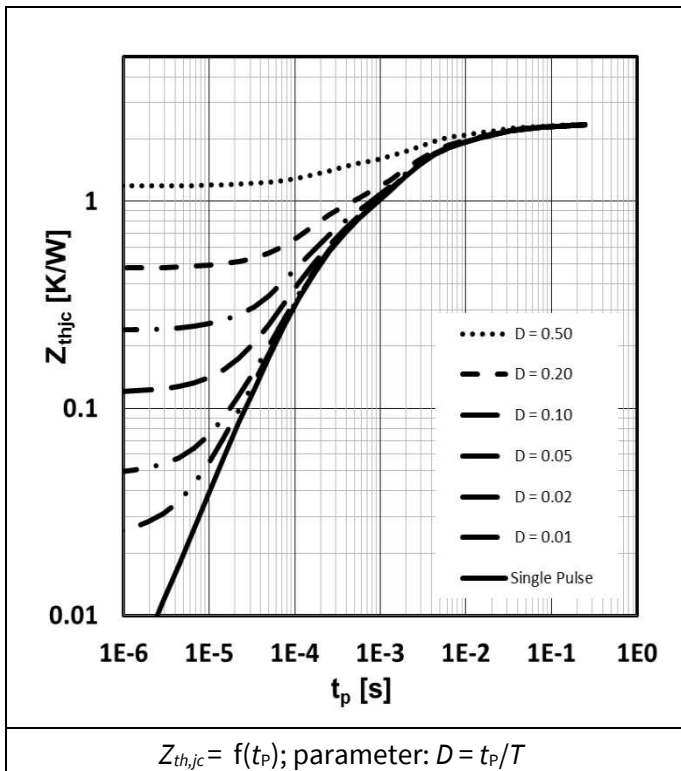

Figure 7 Max. transient thermal impedance

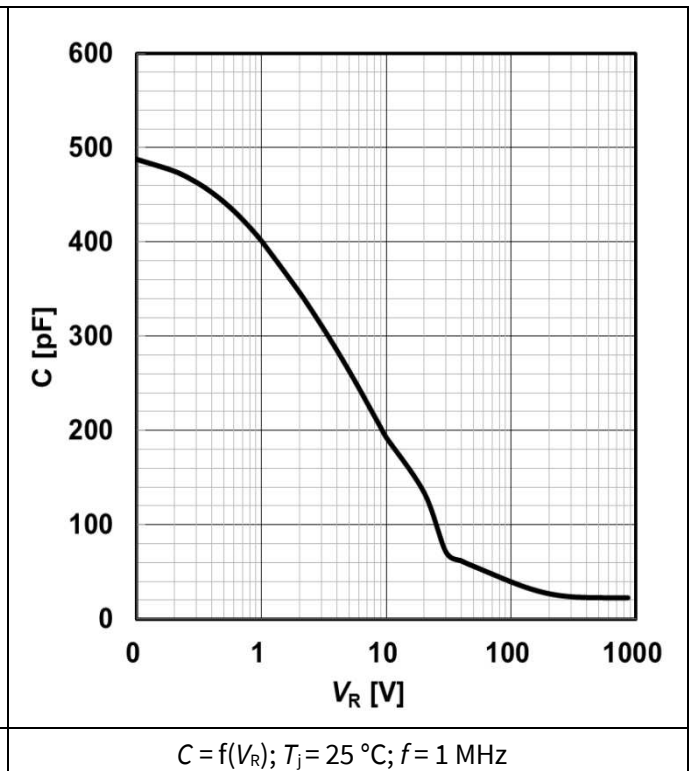

Figure 8 Typ. capacitance vs. reverse voltage

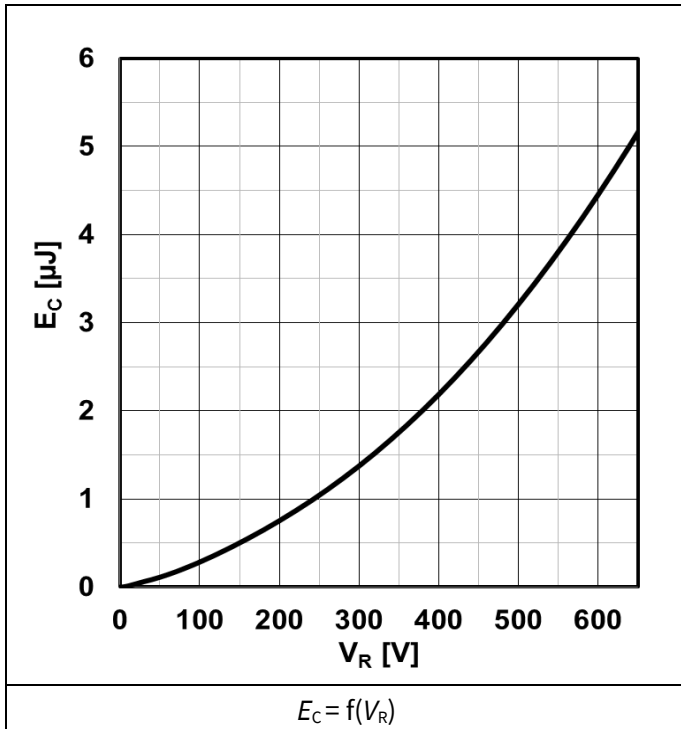

Figure 9 Typ. capacitance stored energy

## 5 Simplified forward characteristic

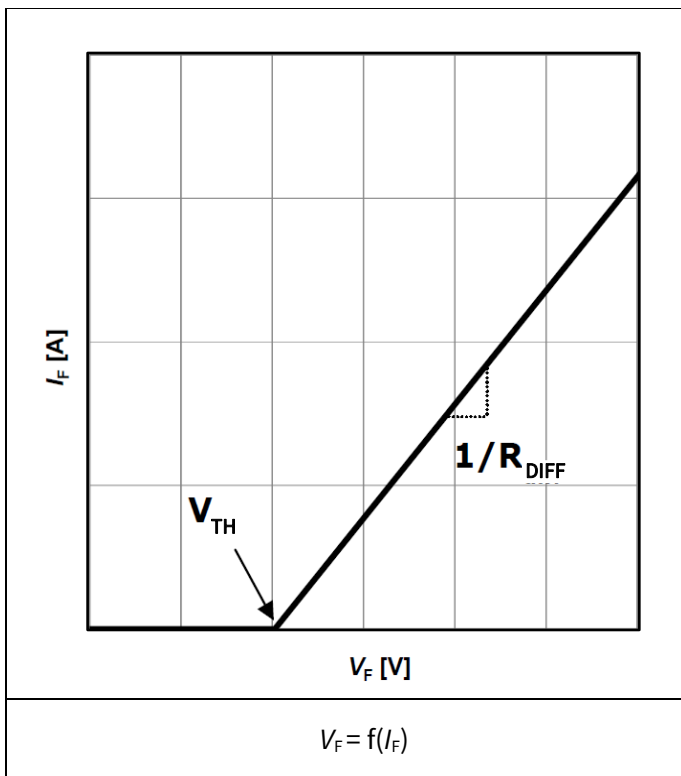

Figure 10 Equivalent forward current curve

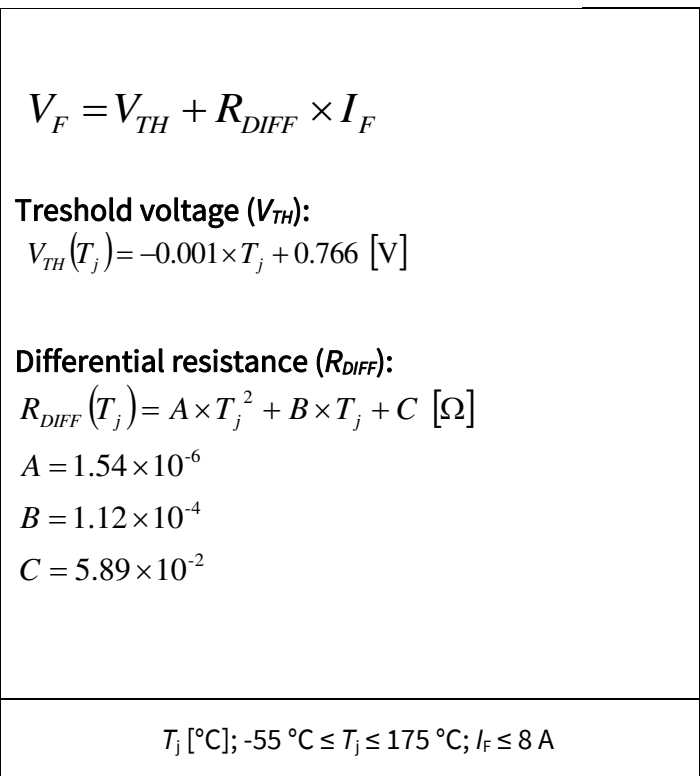

Figure 11 Mathematical Equation



## 6 Package outlines

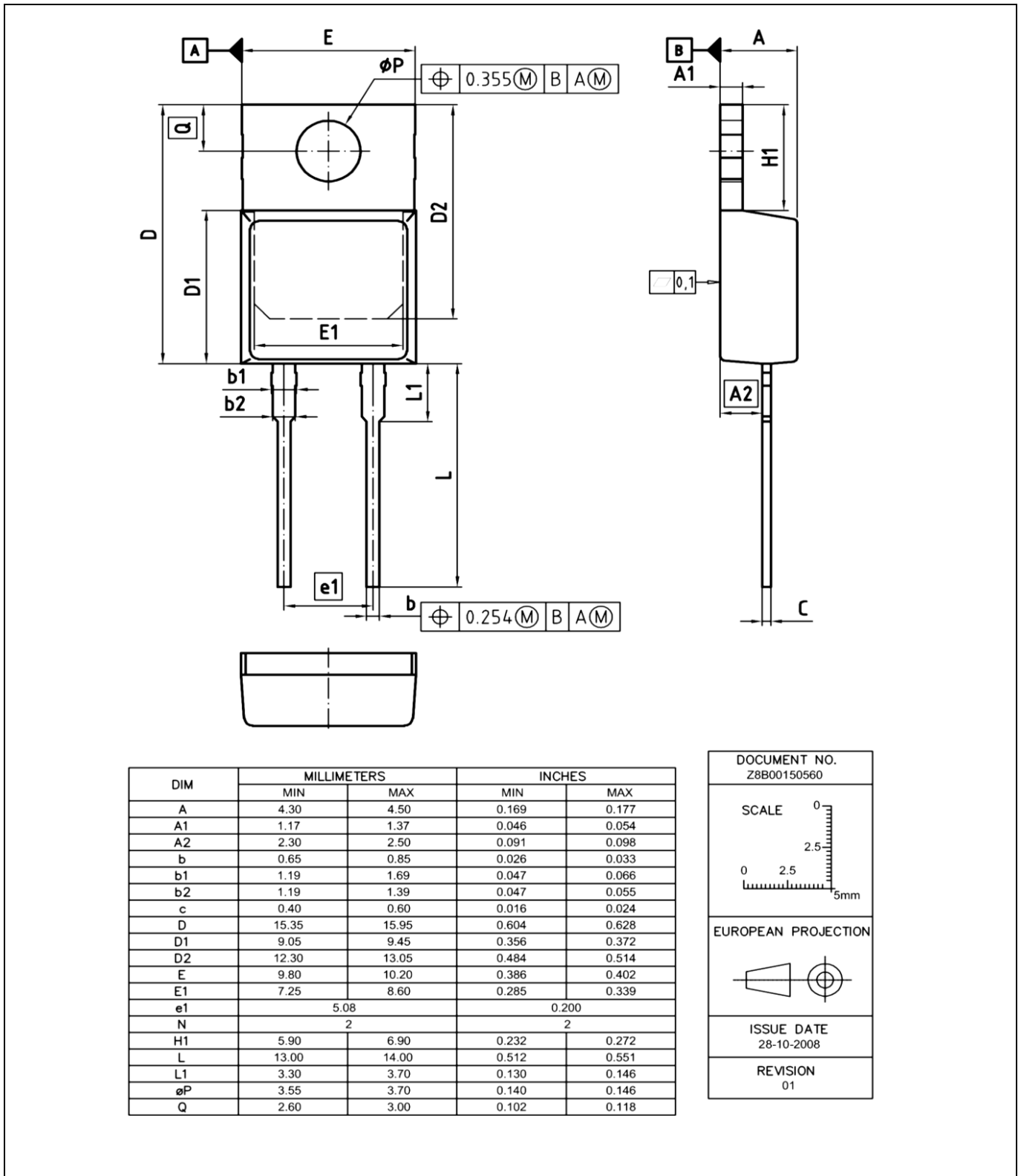

Figure 12 Outlines of the package PG-TO220-2, dimensions in mm/inches

## Revision History

### Major changes since the last revision

Revision	Date	Subject (major changes since last revision)
2.0	2017-05-23	Release of final version

#### Other Trademarks

All referenced product or service names and trademarks are the property of their respective owners.

**Edition 2017-05-23**

**Published by**

**Infineon Technologies AG**

**81726 München, Germany**

**© 2017 Infineon Technologies AG.**

**All Rights Reserved.**

**Do you have a question about this document?**

**Email: [erratum@infineon.com](mailto:erratum@infineon.com)**

**Document reference**

#### IMPORTANT NOTICE

The information given in this document shall in no event be regarded as a guarantee of conditions or characteristics ("Beschaffenheitsgarantie").

With respect to any examples, hints or any typical values stated herein and/or any information regarding the application of the product, Infineon Technologies hereby disclaims any and all warranties and liabilities of any kind, including without limitation warranties of non-infringement of intellectual property rights of any third party.

In addition, any information given in this document is subject to customer's compliance with its obligations stated in this document and any applicable legal requirements, norms and standards concerning customer's products and any use of the product of Infineon Technologies in customer's applications.

The data contained in this document is exclusively intended for technically trained staff. It is the responsibility of customer's technical departments to evaluate the suitability of the product for the intended application and the completeness of the product information given in this document with respect to such application.

For further information on the product, technology, delivery terms and conditions and prices please contact your nearest Infineon Technologies office ([www.infineon.com](http://www.infineon.com)).

#### WARNINGS

Due to technical requirements products may contain dangerous substances. For information on the types in question please contact your nearest Infineon Technologies office.

Except as otherwise explicitly approved by Infineon Technologies in a written document signed by authorized representatives of Infineon Technologies, Infineon Technologies' products may not be used in any applications where a failure of the product or any consequences of the use thereof can reasonably be expected to result in personal injury.