



Chipsmall Limited consists of a professional team with an average of over 10 year of expertise in the distribution of electronic components. Based in Hongkong, we have already established firm and mutual-benefit business relationships with customers from,Europe,America and south Asia,supplying obsolete and hard-to-find components to meet their specific needs.

With the principle of “Quality Parts,Customers Priority,Honest Operation,and Considerate Service”,our business mainly focus on the distribution of electronic components. Line cards we deal with include Microchip,ALPS,ROHM,Xilinx,Pulse,ON,Everlight and Freescale. Main products comprise IC,Modules,Potentiometer,IC Socket,Relay,Connector.Our parts cover such applications as commercial,industrial, and automotives areas.

We are looking forward to setting up business relationship with you and hope to provide you with the best service and solution. Let us make a better world for our industry!



Contact us

Tel: +86-755-8981 8866 Fax: +86-755-8427 6832

Email & Skype: info@chipsmall.com Web: www.chipsmall.com

Address: A1208, Overseas Decoration Building, #122 Zhenhua RD., Futian, Shenzhen, China



**Fast Switching Diode
Features**

- 600 V diode technology
- Fast recovery
- Soft switching
- Low reverse recovery charge
- Low forward voltage
- Easy paralleling
- Pb-free lead plating; RoHS compliant
- Halogen-free according to IEC61249-2-21
- Qualified according to JEDEC for target applications

Product Summary

V_{RRM}	600	V
I_F	23	A
V_F	1.5	V
T_{jmax}	175	°C

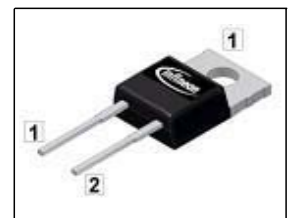
PG-TO220-2

Type	Package	Ordering Code	Marking	Pin 1	PIN 2	PIN 3
IDP23E60	PG-TO220-2	-	D23E60	C	A	-

Maximum Ratings, at $T_j = 25\text{ °C}$, unless otherwise specified

Parameter	Symbol	Value	Unit
Repetitive peak reverse voltage	V_{RRM}	600	V
Continuous forward current	I_F		A
$T_C=25\text{ °C}$		41	
$T_C=90\text{ °C}$		28	
Surge non repetitive forward current	I_{FSM}	89	
$T_C=25\text{ °C}$, $t_p=10\text{ ms}$, sine halfwave			
Maximum repetitive forward current	I_{FRM}	65	
$T_C=25\text{ °C}$, t_p limited by T_{jmax} , $D=0.5$			
Power dissipation	P_{tot}		W
$T_C=25\text{ °C}$		115	
$T_C=90\text{ °C}$		65	
Operating and storage temperature	T_j, T_{stg}	-55... +175	°C
Soldering temperature	T_S	260	°C
wavesoldering, 1.6mm (0.063 in.) from case for 10s			

Thermal Characteristics

Parameter	Symbol	Values			Unit
		min.	typ.	max.	
Characteristics					
Thermal resistance, junction - case	R_{thJC}	-	-	1.3	K/W
SMD version, device on PCB:	R_{thJA}	-	-	75	
@ min. footprint @ 6 cm ² cooling area ¹⁾		-	-	50	

Electrical Characteristics, at $T_j = 25\text{ °C}$, unless otherwise specified

Parameter	Symbol	Values			Unit
		min.	typ.	max.	
Static Characteristics					
Reverse leakage current $V_R=600V, T_j=25\text{ °C}$ $V_R=600V, T_j=150\text{ °C}$	I_R	-	-	50 1900	μA
Forward voltage drop $I_F=23A, T_j=25\text{ °C}$ $I_F=23A, T_j=150\text{ °C}$	V_F	-	1.5 1.5	2 -	

⁰J-STD20 and JESD22

¹Device on 40mm*40mm*1.5mm epoxy PCB FR4 with 6cm² (one layer, 70 μm thick) copper area for drain connection. PCB is vertical without blown air.

Electrical Characteristics, at $T_j = 25\text{ °C}$, unless otherwise specified

Parameter	Symbol	Values			Unit
		min.	typ.	max.	
Dynamic Characteristics					
Reverse recovery time $V_R=400\text{V}$, $I_F=23\text{A}$, $di_F/dt=1000\text{A}/\mu\text{s}$, $T_j=25\text{°C}$ $V_R=400\text{V}$, $I_F=23\text{A}$, $di_F/dt=1000\text{A}/\mu\text{s}$, $T_j=125\text{°C}$ $V_R=400\text{V}$, $I_F=23\text{A}$, $di_F/dt=1000\text{A}/\mu\text{s}$, $T_j=150\text{°C}$	t_{rr}	-	120	-	ns
Peak reverse current $V_R=400\text{V}$, $I_F = 23\text{A}$, $di_F/dt=1000\text{A}/\mu\text{s}$, $T_j=25\text{°C}$ $V_R=400\text{V}$, $I_F = 23\text{A}$, $di_F/dt=1000\text{A}/\mu\text{s}$, $T_j=125\text{°C}$ $V_R=400\text{V}$, $I_F = 23\text{A}$, $di_F/dt=1000\text{A}/\mu\text{s}$, $T_j=150\text{°C}$	I_{rrm}	-	17	-	A
Reverse recovery charge $V_R=400\text{V}$, $I_F=23\text{A}$, $di_F/dt=1000\text{A}/\mu\text{s}$, $T_j=25\text{°C}$ $V_R=400\text{V}$, $I_F = 23\text{A}$, $di_F/dt=1000\text{A}/\mu\text{s}$, $T_j=125\text{°C}$ $V_R=400\text{V}$, $I_F = 23\text{A}$, $di_F/dt=1000\text{A}/\mu\text{s}$, $T_j=150\text{°C}$	Q_{rr}	-	970	-	nC
Reverse recovery softness factor $V_R=400\text{V}$, $I_F=23\text{A}$, $di_F/dt=1000\text{A}/\mu\text{s}$, $T_j=25\text{°C}$ $V_R=400\text{V}$, $I_F=23\text{A}$, $di_F/dt=1000\text{A}/\mu\text{s}$, $T_j=125\text{°C}$ $V_R=400\text{V}$, $I_F=23\text{A}$, $di_F/dt=1000\text{A}/\mu\text{s}$, $T_j=150\text{°C}$	S	-	4.4	-	

1 Power dissipation

$P_{tot} = f(T_C)$

parameter: $T_j \leq 175\text{ °C}$

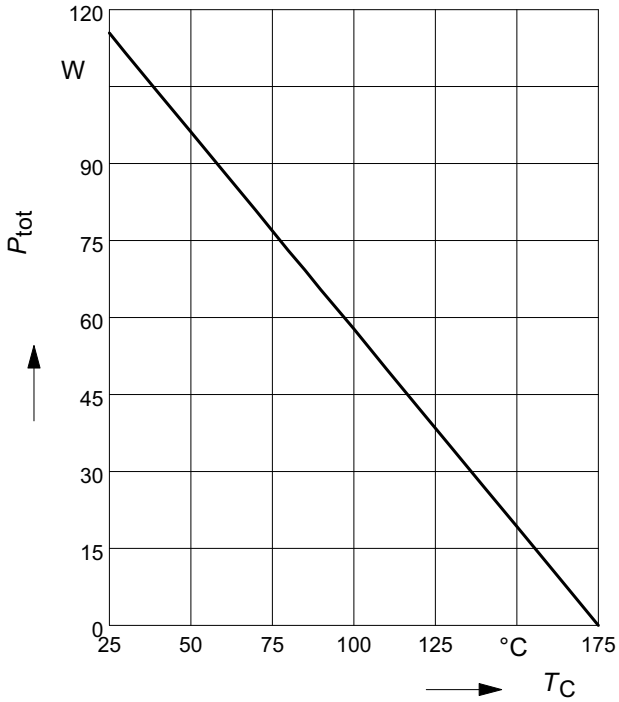

2 Diode forward current

$I_F = f(T_C)$

parameter: $T_j \leq 175\text{ °C}$

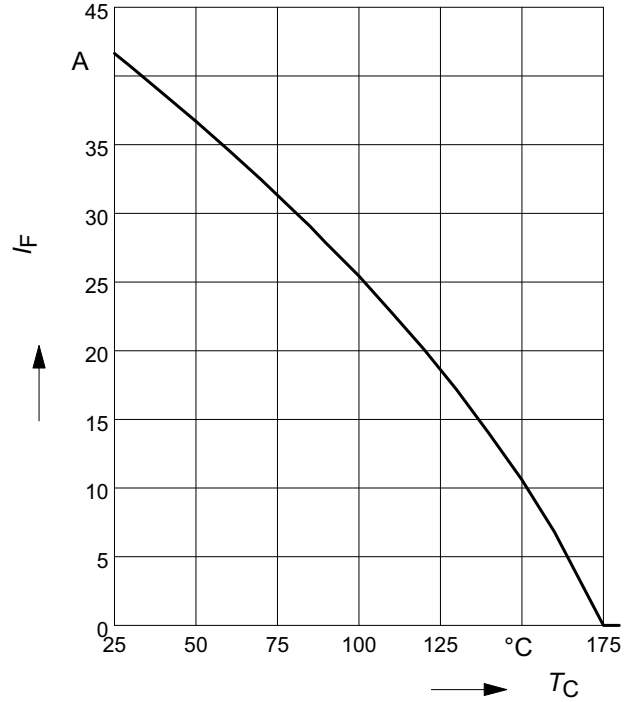

3 Typ. diode forward current

$I_F = f(V_F)$

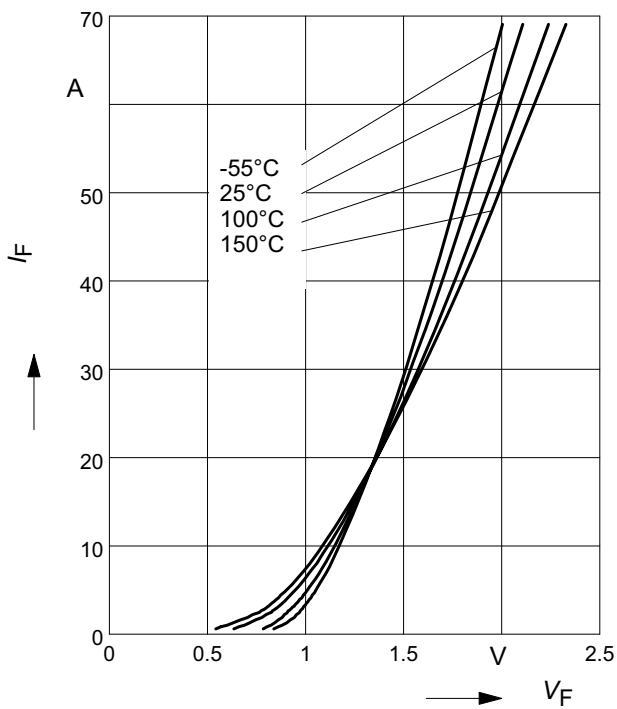

4 Typ. diode forward voltage

$V_F = f(T_j)$

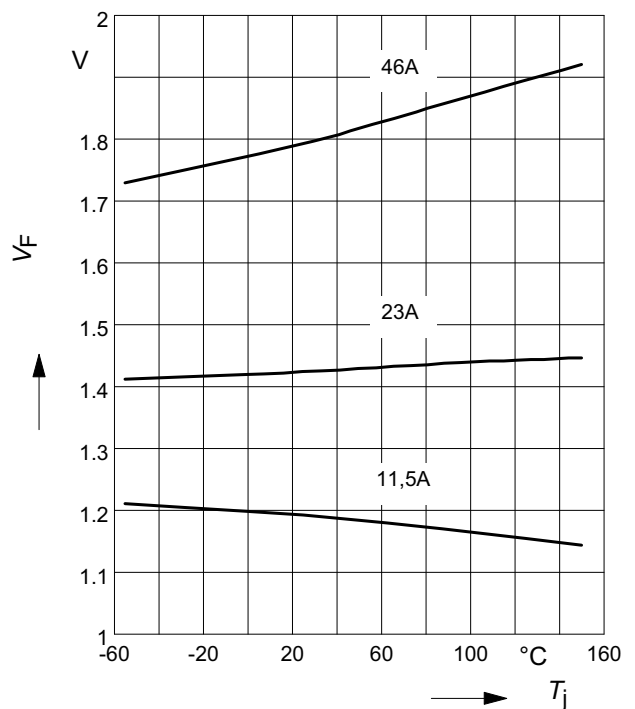

5 Typ. reverse recovery time

$$t_{rr} = f(dI_F/dt)$$

parameter: $V_R = 400V, T_j = 125^\circ C$

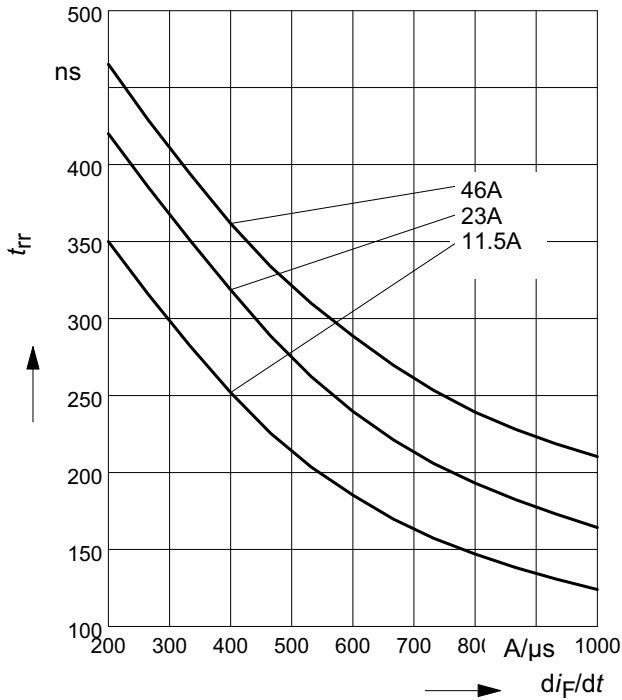

6 Typ. reverse recovery charge

$$Q_{rr} = f(dI_F/dt)$$

parameter: $V_R = 400V, T_j = 125^\circ C$

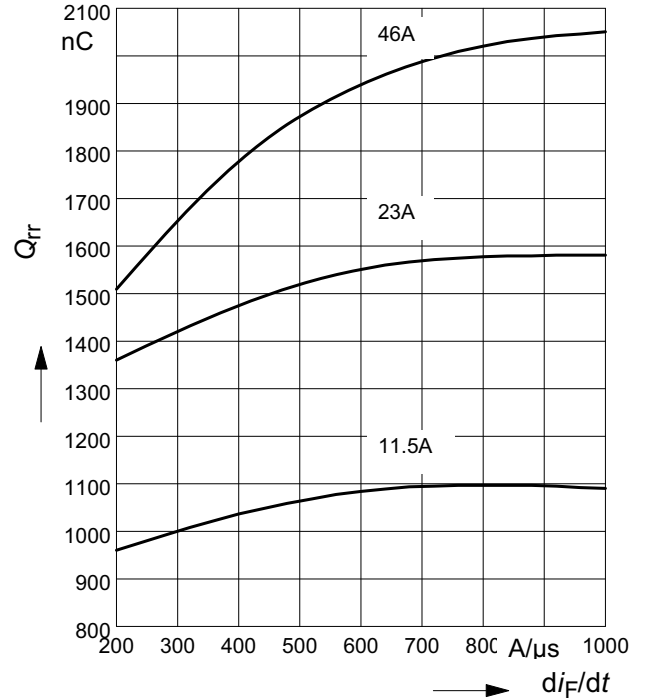

7 Typ. reverse recovery current

$$I_{rr} = f(dI_F/dt)$$

parameter: $V_R = 400V, T_j = 125^\circ C$

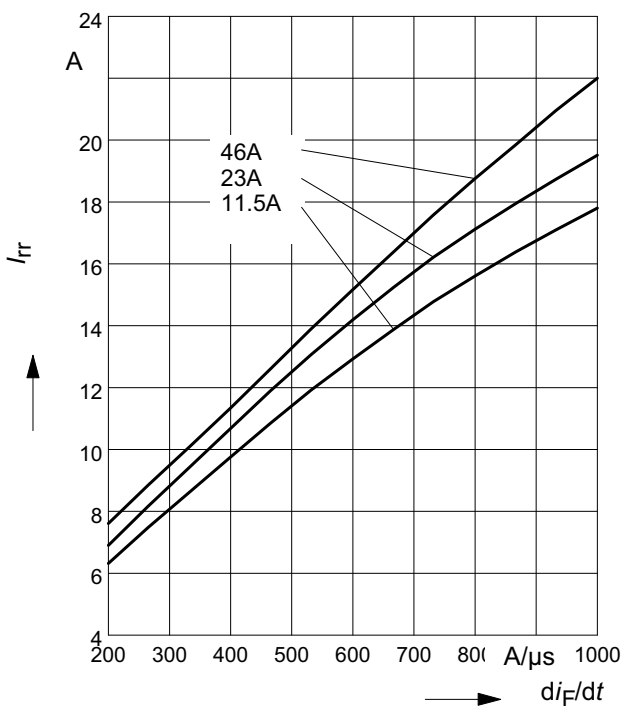

8 Typ. reverse recovery softness factor

$$S = f(dI_F/dt)$$

parameter: $V_R = 400V, T_j = 125^\circ C$

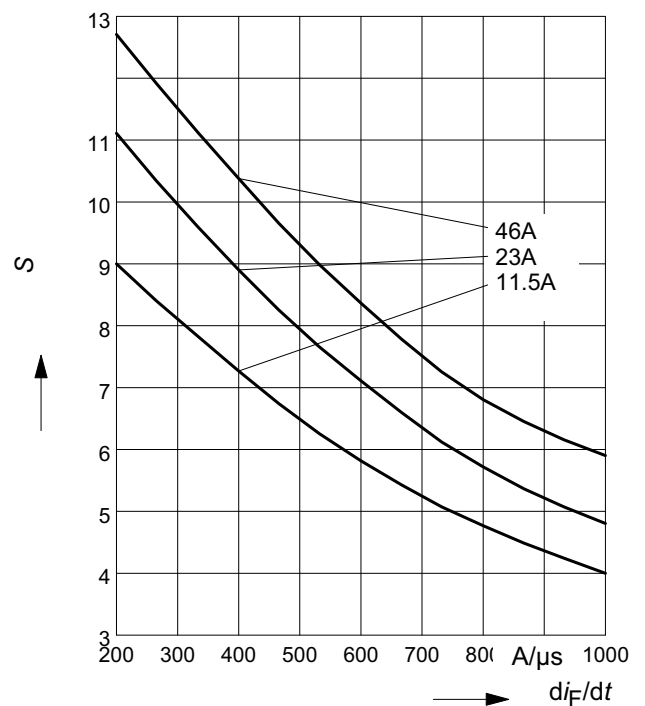

9 Max. transient thermal impedance

$$Z_{thJC} = f(t_p)$$

parameter : $D = t_p/T$

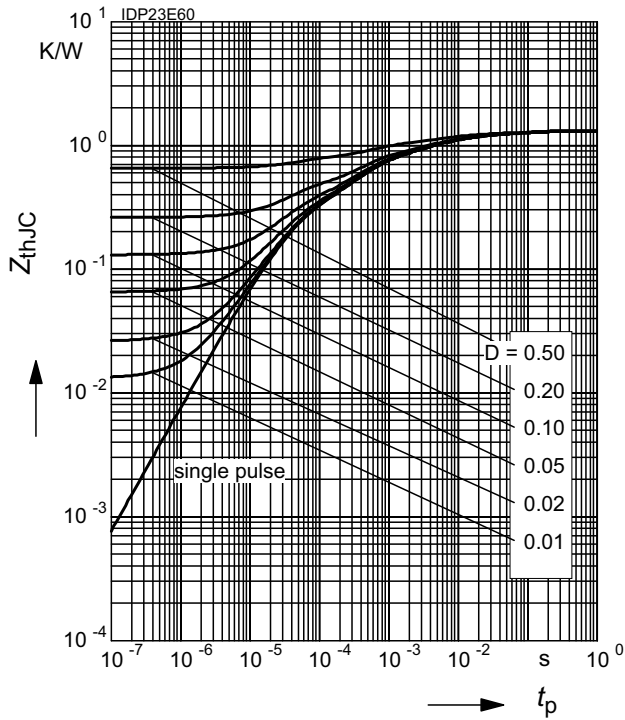

Outline drawing: TO220-2-1

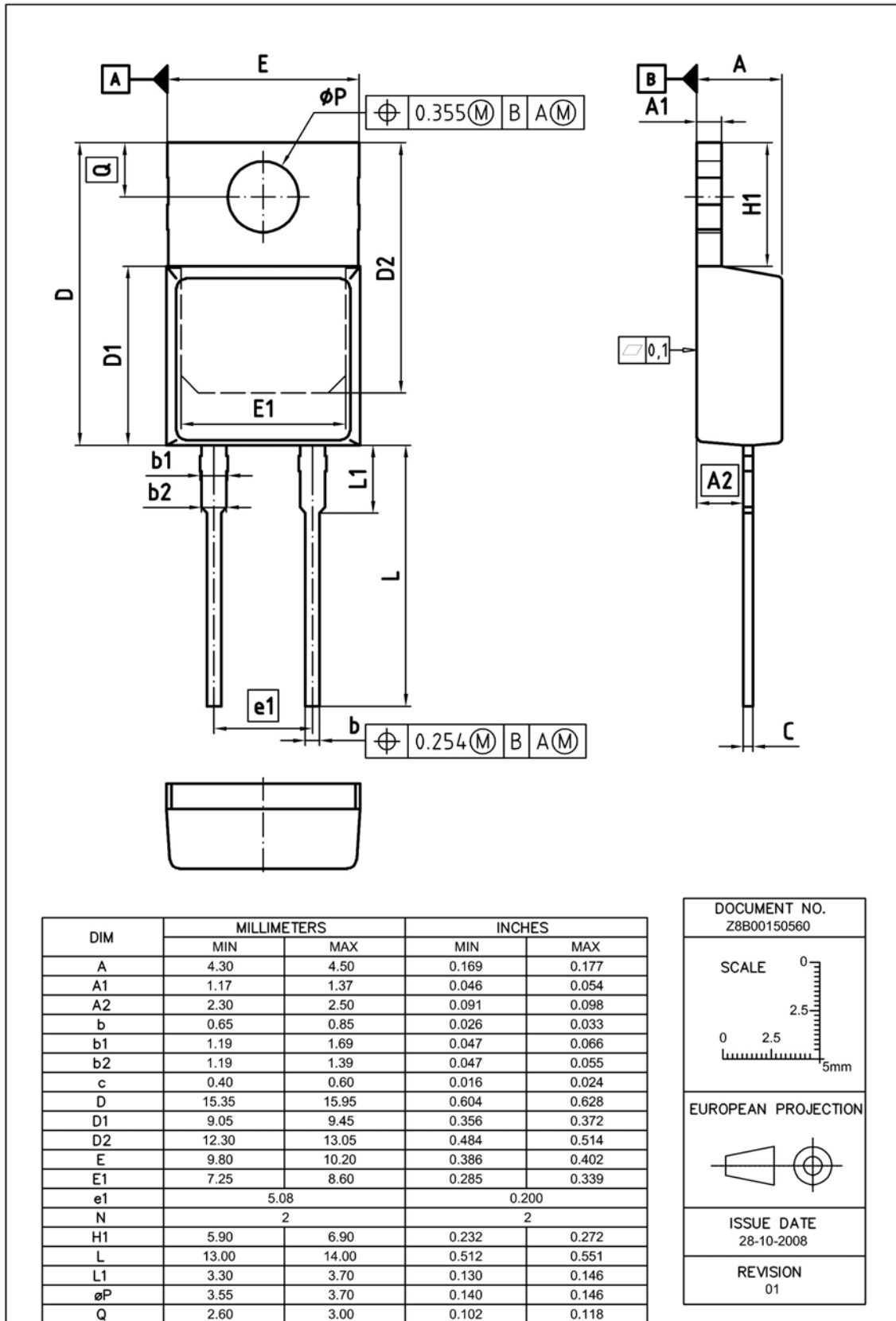

Published by
Infineon Technologies AG
81726 Munich, Germany
81726 München, Germany
© 2009 Infineon Technologies AG
All Rights Reserved.

Legal Disclaimer

The information given in this document shall in no event be regarded as a guarantee of conditions or characteristics. With respect to any examples or hints given herein, any typical values stated herein and/or any information regarding the application of the device, Infineon Technologies hereby disclaims any and all warranties and liabilities of any kind, including without limitation, warranties of non-infringement of intellectual property rights of any third party.

Information

For further information on technology, delivery terms and conditions and prices, please contact the nearest Infineon Technologies Office (www.infineon.com).

Warnings

Due to technical requirements, components may contain dangerous substances. For information on the types in question, please contact the nearest Infineon Technologies Office. Infineon Technologies components may be used in life-support devices or systems only with the express written approval of Infineon Technologies, if a failure of such components can reasonably be expected to cause the failure of that life-support device or system or to affect the safety or effectiveness of that device or system. Life support devices or systems are intended to be implanted in the human body or to support and/or maintain and sustain and/or protect human life. If they fail, it is reasonable to assume that the health of the user or other persons may be endangered.