



Chipsmall Limited consists of a professional team with an average of over 10 year of expertise in the distribution of electronic components. Based in Hongkong, we have already established firm and mutual-benefit business relationships with customers from,Europe,America and south Asia,supplying obsolete and hard-to-find components to meet their specific needs.

With the principle of “Quality Parts,Customers Priority,Honest Operation,and Considerate Service”,our business mainly focus on the distribution of electronic components. Line cards we deal with include Microchip,ALPS,ROHM,Xilinx,Pulse,ON,Everlight and Freescale. Main products comprise IC,Modules,Potentiometer,IC Socket,Relay,Connector.Our parts cover such applications as commercial,industrial, and automotives areas.

We are looking forward to setting up business relationship with you and hope to provide you with the best service and solution. Let us make a better world for our industry!



## Contact us

Tel: +86-755-8981 8866 Fax: +86-755-8427 6832

Email & Skype: info@chipsmall.com Web: www.chipsmall.com

Address: A1208, Overseas Decoration Building, #122 Zhenhua RD., Futian, Shenzhen, China





**■ Features**

- Constant Current mode output
- Flicker free design
- PCB type design
- Built-in active PFC function
- No load power consumption<0.5W(Blank-Type), Standby power consumption<0.5W(DA-Type)
- Function options: 2 in 1 dimming (dim-to-off); Auxiliary DC output; DALI
- 3 years warranty

**■ Applications**

- LED panel lighting
- LED flood lighting
- Indoor LED lighting

**■ Description**

IDPC-65 series is a 65W PCB type LED AC/DC driver featuring the constant current mode output with flicker free design. IDPC-65 operates from 180~295VAC and offers models with different rated current ranging between 700mA and 1750mA. Thanks to the efficiency up to 89%, with the fanless design, the entire series is able to operate for -20°C~+40°C ambient temperature under free air convection. IDPC-65 is equipped with various function options, such as dimming methodologies, so as to provide the optimal design flexibility for lighting system.

**■ Model Encoding**

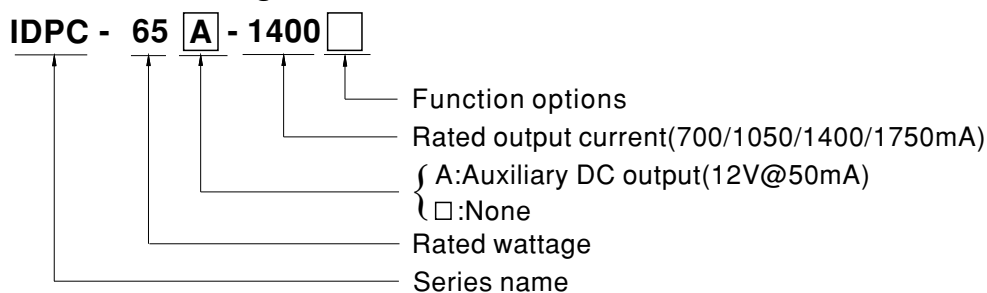

| Type  | Function                             | Note     |
|-------|--------------------------------------|----------|
| Blank | 2 in 1 dimming (0~10VDC and 10V PWM) | In Stock |
| DA    | DALI control technology              | In Stock |

Note: The DALI control model(DA Type) only for IDPC-65 Non Auxiliary DC output models.



**SPECIFICATION**

| MODEL        |  | IDPC-65□-700□   | IDPC-65□-1050□ | IDPC-65□-1400□ | IDPC-65□-1750□ |
|--------------|--|---|----------------|----------------|----------------|
| OUTPUT       | RATED CURRENT  | 700mA   | 1050mA         | 1400mA         | 1750mA         |
|              | RATED POWER  | 65.1W   | 65.1W          | 64.4W          | 63W            |
|              | CONSTANT CURRENT REGION <small>Note.2</small>  | 69 ~ 93V  | 46 ~ 62V       | 34 ~ 46V       | 27 ~ 36V       |
|              | OPEN CIRCUIT VOLTAGE <sub>(max.)</sub>   | 118V  | 82V            | 60V            | 53V            |
|              | CURRENT RIPPLE   | 5% max. @rated current  |                |                |                |
|              | CURRENT TOLERANCE  | ±7.0%   |                |                |                |
|              | SETUP TIME <small>Note.4</small>   | 500ms / 230VAC  |                |                |                |
|              | AUXILIARY DC OUTPUT <small>Note.5</small>  | Nominal 12V(deviation 11.4~12.6)@50mA for IDPC-65A only   |                |                |                |
| INPUT        | VOLTAGE RANGE <small>Note.3</small>  | 180 ~ 295VAC    254 ~ 417VDC<br>(Please refer to "STATIC CHARACTERISTIC" section)   |                |                |                |
|              | FREQUENCY RANGE  | 47 ~ 63Hz   |                |                |                |
|              | POWER FACTOR (Typ.)  | PF>0.95/230VAC, PF>0.9/277VAC@full load<br>(Please refer to "POWER FACTOR (PF) CHARACTERISTIC" section)                         |                |                |                |
|              | TOTAL HARMONIC DISTORTION  | THD<20%@load≥75%/230VAC, 277VAC<br>(Please refer to "TOTAL HARMONIC DISTORTION" section)  |                |                |                |
|              | EFFICIENCY (Typ.)  | 89%   | 87%            | 86%            | 86%            |
|              | AC CURRENT   | 0.4A/230VAC    0.3A/277VAC  |                |                |                |
|              | INRUSH CURRENT (Typ.)  | COLD START 30A(twidth=100μs measured at 50% Ipeak) at 230VAC; Per NEMA 410  |                |                |                |
|              | MAX. No. of PSUs on 16A CIRCUIT BREAKER  | 32 units (circuit breaker of type B) / 32 units (circuit breaker of type C) at 230VAC   |                |                |                |
|              | LEAKAGE CURRENT  | <0.75mA / 277VAC  |                |                |                |
|              | NO LOAD / STANDBY POWER CONSUMPTION  | No load power consumption <0.5W for Blank-Type, <1.2W for IDPC-65A<br>Standby power consumption <0.5W for DA-Type               |                |                |                |
| PROTECTION   | SHORT CIRCUIT  | Hiccup mode, auto-recovery after fault condition is removed for DA type;<br>Hiccup mode, re-power on to recovery for other type |                |                |                |
| ENVIRONMENT  | WORKING TEMP.  | Ta= -20 ~ +40°C (ambient temperature)   |                |                |                |
|              | WORKING HUMIDITY   | 20 ~ 90% RH non-condensing  |                |                |                |
|              | STORAGE TEMP., HUMIDITY  | -40 ~ +80°C, 10 ~ 95% RH  |                |                |                |
|              | TEMP. COEFFICIENT  | ±0.03%/°C (0 ~ 40°C)  |                |                |                |
|              | VIBRATION  | 10 ~ 500Hz, 2G 10min./1cycle, period for 60min. each along X, Y, Z axes   |                |                |                |
| SAFETY & EMC | SAFETY STANDARDS   | UL8750, CSA C22.2 NO.250.13-12; ENEC EN61347-1, EN61347-2-13, EN62384, GB19510.1, GB19510.14, EAC TP TC 004 approved            |                |                |                |
|              | DALI STANDARDS <small>Note.7</small>   | Compliance to IEC62386-101,102 for DA-Type only   |                |                |                |
|              | WITHSTAND VOLTAGE  | I/P-O/P:3.75KVAC  |                |                |                |
|              | ISOLATION RESISTANCE   | I/P-O/P:100M Ohms / 500VDC / 25°C/ 70% RH   |                |                |                |
|              | EMC EMISSION   | Compliance to EN55015, EN61000-3-2 Class C (≥75% load) ; EN61000-3-3, GB17743, GB17625.1, EAC TP TC 020                         |                |                |                |
|              | EMC IMMUNITY   | Compliance to EN61000-4-2,3,4,5,6,8,11; EN61547, light industry level(surge immunity:Line-Line:1KV), EAC TP TC 020              |                |                |                |
| OTHERS       | MTBF   | 380.7Khrs min.    MIL-HDBK-217F (25°C)  |                |                |                |
|              | DIMENSION  | 130*67.5*20.5mm(L*W*H)  |                |                |                |
|              | PACKING  | 0.15Kg; 81pcs/ 13Kg/ 1.46CUFT   |                |                |                |
| NOTE         | <ol style="list-style-type: none"> <li>All parameters NOT specially mentioned are measured at 230VAC input, rated current and 25°C of ambient temperature.</li> <li>Please refer to "DRIVING METHODS OF LED MODULE".</li> <li>De-rating may be needed under low input voltages. Please refer to "STATIC CHARACTERISTIC" sections for details.</li> <li>Length of set up time is measured at cold first start. Turning ON/OFF the driver may lead to increase of the set up time or set up failure.</li> <li>Aux. 12V will be damaged with short circuit; It will not be available when output voltage is not in constant current region or output no load condition.</li> <li>The driver is considered as a component that will be operated in combination with final equipment. Since EMC performance will be affected by the complete installation, the final equipment manufacturers must re-qualify EMC Directive on the complete installation again.</li> <li>The DALI version driver does not support the bit 1: Lamp failure in the Command 144 Query status of the DALI standard.</li> </ol> |   |                |                |                |

■ **BLOCK DIAGRAM**

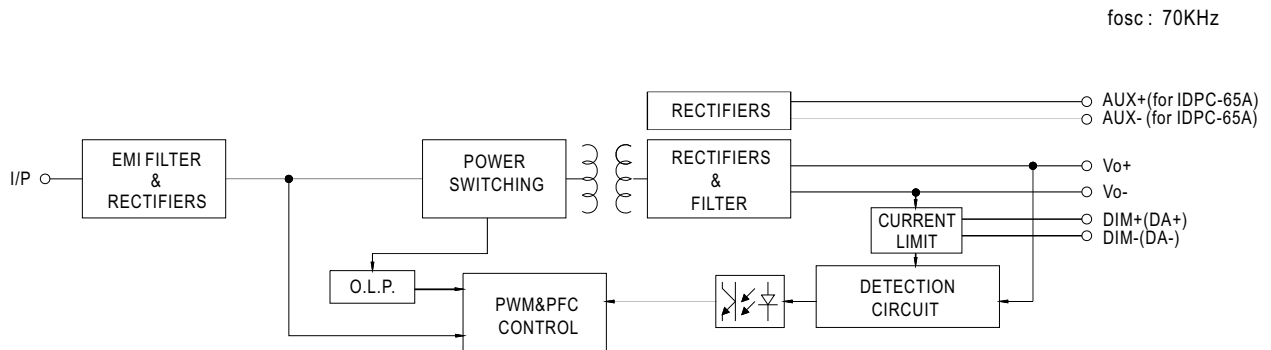

■ **DRIVING METHODS OF LED MODULE**

※ This series works in constant current mode to directly drive the LEDs.

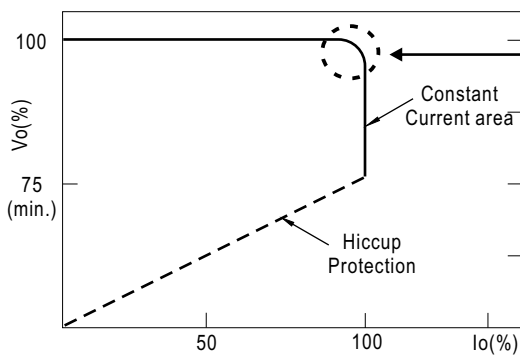

Typical output current normalized by rated current (%)

In the constant current region, the highest voltage at the output of the driver depends on the configuration of the end systems.  
Should there be any compatibility issues, please contact MEAN WELL.

**■ DIMMING OPERATION**

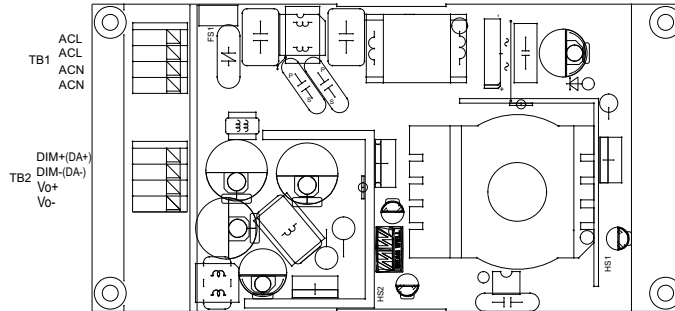

※ **2 in 1 dimming function**

- Output constant current level can be adjusted by applying one of the two methodologies between DIM+ and DIM-: 0 ~ 10VDC, or 10V PWM signal.
- Direct connecting to LEDs is suggested. It is not suitable to be used with additional drivers.

◎ Applying additive 0 ~ 10VDC

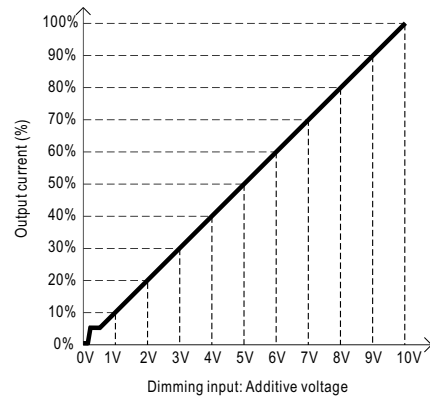
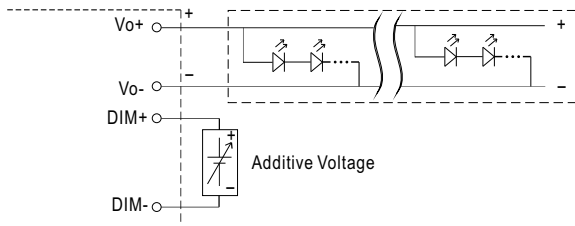

◎ Applying additive 10V PWM signal (frequency range 300Hz ~ 3KHz):

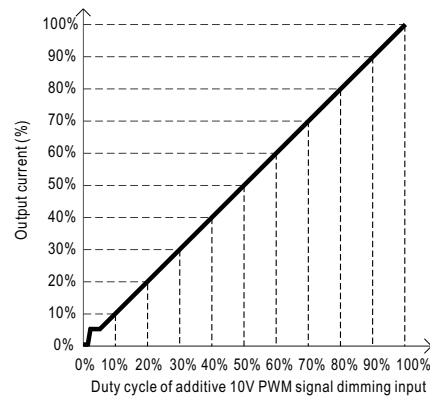
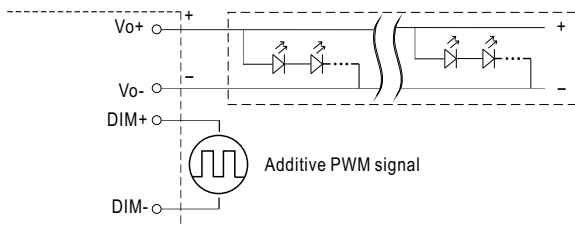

Note : 1. Min. dimming level is about 8% and the output current is not defined when  $0% < I_{out} < 8%$ .  
 2. The output current could drop down to 0% when dimming input is about 0Vdc or 10V PWM signal with 0% duty cycle.

※ **DALI Interface (primary side; for DA-Type)**

- Apply DALI signal between DA+ and DA-.
- DALI protocol comprises 16 groups and 64 addresses.
- First step is fixed at 8% of output.

**OUTPUT LOAD vs TEMPERATURE**

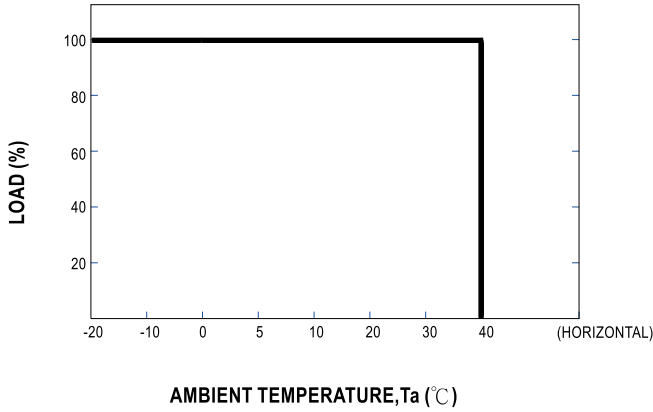

**STATIC CHARACTERISTIC**

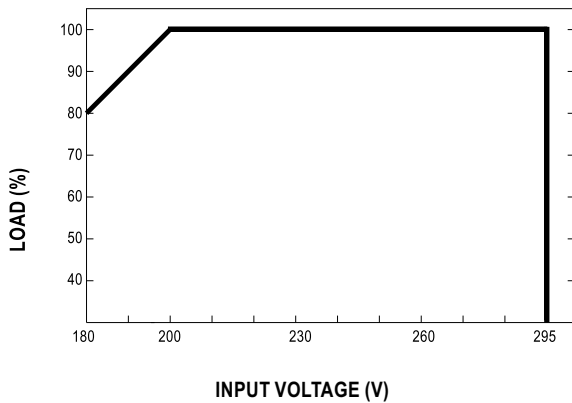

※ De-rating is needed under low input voltage.

**POWER FACTOR (PF) CHARACTERISTIC**

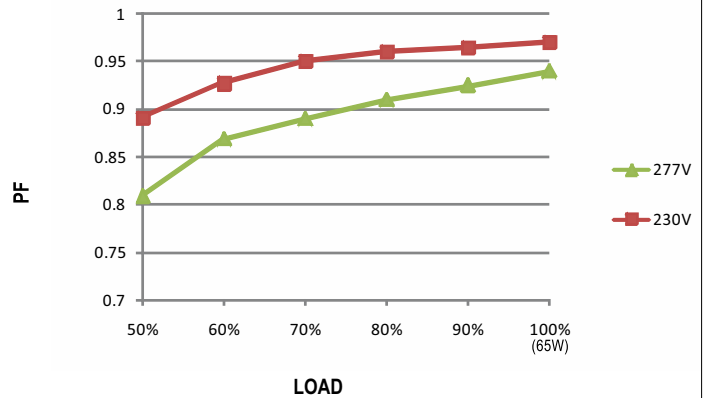

**TOTAL HARMONIC DISTORTION (THD)**

※ 700mA Model

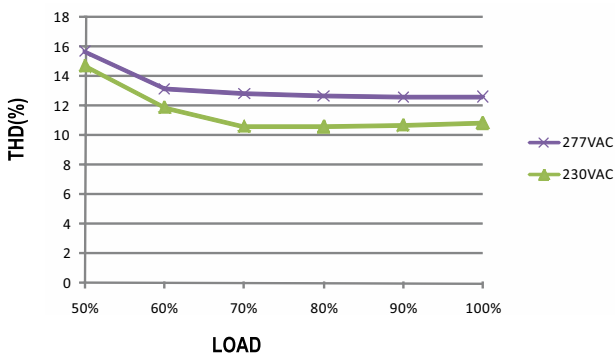

**EFFICIENCY vs LOAD**

IDPC-65 series possess superior working efficiency that up to 89% can be reached in field applications.

※ 700mA Model

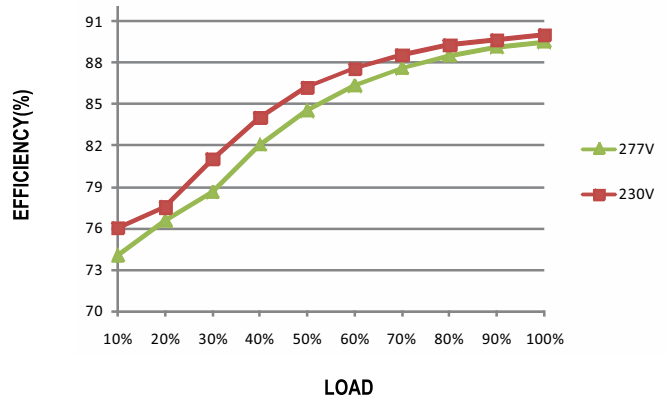

MECHANICAL SPECIFICATION

Unit:mm

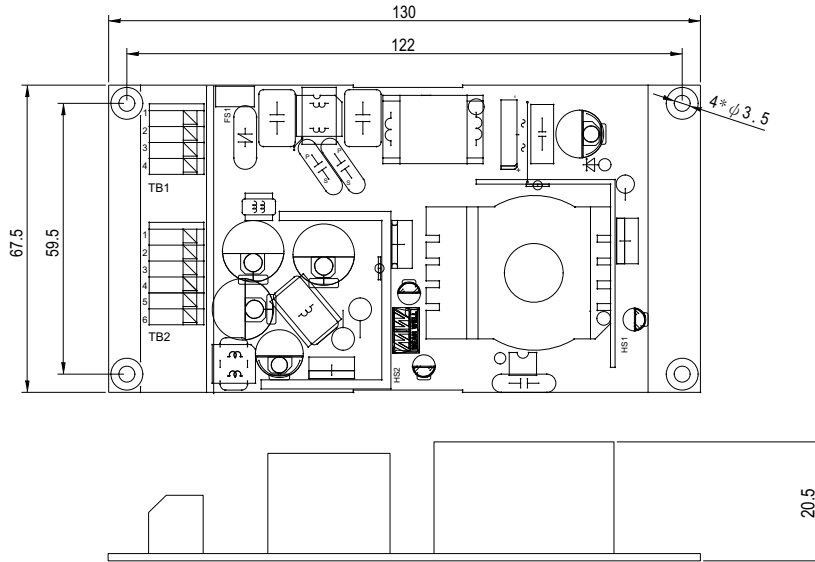

Terminal Pin No. Assignment(TB1)

| Pin No. | Assignment |
|---------|------------|
| 1       | ACL        |
| 2       | ACL        |
| 3       | ACN        |
| 4       | ACN        |

IDPC-65

Terminal Pin No. Assignment(TB2)

| Pin No. | Assignment |
|---------|------------|
| 1       | DIM+ (DA+) |
| 2       | DIM- (DA-) |
| 3       | Vo+        |
| 4       | Vo-        |

IDPC-65A

Terminal Pin No. Assignment(TB2)

| Pin No. | Assignment | Pin No. | Assignment |
|---------|------------|---------|------------|
| 1       | DIM+       | 4       | Vo-        |
| 2       | DIM-       | 5       | AUX+       |
| 3       | Vo+        | 6       | AUX-       |

INSTALLATION MANUAL

Please refer to :<http://www.meanwell.com/manual.html>