



Chipsmall Limited consists of a professional team with an average of over 10 year of expertise in the distribution of electronic components. Based in Hongkong, we have already established firm and mutual-benefit business relationships with customers from,Europe,America and south Asia,supplying obsolete and hard-to-find components to meet their specific needs.

With the principle of “Quality Parts,Customers Priority,Honest Operation,and Considerate Service”,our business mainly focus on the distribution of electronic components. Line cards we deal with include Microchip,ALPS,ROHM,Xilinx,Pulse,ON,Everlight and Freescale. Main products comprise IC,Modules,Potentiometer,IC Socket,Relay,Connector.Our parts cover such applications as commercial,industrial, and automotives areas.

We are looking forward to setting up business relationship with you and hope to provide you with the best service and solution. Let us make a better world for our industry!



## Contact us

Tel: +86-755-8981 8866 Fax: +86-755-8427 6832

Email & Skype: info@chipsmall.com Web: www.chipsmall.com

Address: A1208, Overseas Decoration Building, #122 Zhenhua RD., Futian, Shenzhen, China



## Silicon Carbide Schottky Diode

# IDW15G120C5B

5<sup>th</sup> Generation thinQ!<sup>TM</sup> 1200 V SiC Schottky Diode

## Final Datasheet

Rev. 2.0 2014-06-10

## Industrial Power Control

## thinQ!<sup>TM</sup> SiC Schottky Diode

### Features:

- Revolutionary semiconductor material - Silicon Carbide
- No reverse recovery current / No forward recovery
- Temperature independent switching behavior
- Low forward voltage even at high operating temperature
- Tight forward voltage distribution
- Excellent thermal performance
- Extended surge current capability
- Specified dv/dt ruggedness
- Qualified according to JEDEC<sup>1)</sup> for target applications
- Pb-free lead plating; RoHS compliant

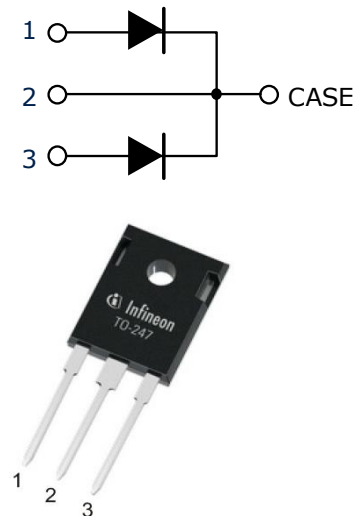

### Benefits

- System efficiency improvement over Si diodes
- Enabling higher frequency / increased power density solutions
- System size/cost savings due to reduced heatsink requirements and smaller magnetics
- Reduced EMI
- Highest efficiency across the entire load range
- Robust diode operation during surge events
- High reliability
- RelatedLinks: [www.infineon.com/sic](http://www.infineon.com/sic)



### Applications

- Solar inverters
- Uninterruptable power supplies
- Motor drives
- Power Factor Correction



### Package pin definitions

- Pin 1 – anode 1
- Pin 2 and backside – cathode
- Pin 3 – anode 2



### Key Performance and Package Parameters (leg/device)

Type	V <sub>DC</sub>	I <sub>F</sub>	Q <sub>C</sub>	T <sub>j,max</sub>	Marking	Package
IDW15G120C5B	1200V	7.5 / 15 A	41 / 82 nC	175°C	D1512B5	PG-TO247-3

1) J-STD20 and JESD22

**Table of Contents**

Description.....	2
Table of Contents.....	3
Maximum ratings.....	4
Thermal Resistances .....	4
Electrical Characteristics.....	5
Electrical Characteristics diagram .....	6
Package Drawings .....	9
Revision History .....	10
Disclaimer.....	10

**Maximum ratings**

Parameter	Symbol	Value (leg/device)	Unit
Repetitive peak reverse voltage	$V_{RRM}$	1200	V
Continuous forward current for $R_{th(j-c,max)}$ $T_C = 154^\circ\text{C}$ , $D=1$ $T_C = 135^\circ\text{C}$ , $D=1$ $T_C = 25^\circ\text{C}$ , $D=1$	$I_F$	7.5 / 15 11 / 23 24 / 49	A
Surge non-repetitive forward current, sine halfwave $T_C=25^\circ\text{C}$ , $t_p=10\text{ms}$ $T_C=150^\circ\text{C}$ , $t_p=10\text{ms}$	$I_{F,SM}$	85 / 170 80 / 160	A
Non-repetitive peak forward current $T_C = 25^\circ\text{C}$ , $t_p=10 \mu\text{s}$	$I_{F,max}$	711 / 1422	A
$i^2t$ value $T_C = 25^\circ\text{C}$ , $t_p=10 \text{ms}$ $T_C = 150^\circ\text{C}$ , $t_p=10 \text{ms}$	$\int i^2 dt$	36 / 143 32 / 128	A <sup>2</sup> s
Diode $dv/dt$ ruggedness $V_R=0\dots960 \text{V}$	$dv/dt$	80	V/ns
Power dissipation for $R_{th(j-c,max)}$ $T_C = 25^\circ\text{C}$	$P_{tot}$	100 / 200	W
Operating and storage temperature	$T_J; T_{stg}$	-55...175	°C
Soldering temperature, wavesoldering only allowed at leads 1.6mm (0.063 in.) from case for 10 s	$T_{sold}$	260	°C
Mounting torque M3 and M4 screws	$M$	0.7	Nm

**Thermal Resistances**

Parameter	Symbol	Conditions	Value (leg/device)			Unit
			min.	typ.	max.	
<b>Characteristic</b>						
Diode thermal resistance, junction – case	$R_{th(j-c)}$		-	1.1/0.6	1.5/0.8	K/W
Thermal resistance, junction – ambient	$R_{th(j-a)}$	leaded	-	-	62	K/W

**Electrical Characteristics**
**Static Characteristic, at T<sub>j</sub>=25°C, unless otherwise specified**

Parameter	Symbol	Conditions	Value (leg/device)			Unit
			min.	typ.	max.	
DC blocking voltage	V <sub>DC</sub>	T <sub>j</sub> = 25°C	1200	-	-	V
Diode forward voltage	V <sub>F</sub>	I <sub>F</sub> = 7.5/15 A, T <sub>j</sub> = 25°C	-	1.4	1.65	V
		I <sub>F</sub> = 7.5/15 A, T <sub>j</sub> = 150°C	-	1.7	2.30	
Reverse current	I <sub>R</sub>	V <sub>R</sub> = 1200V, T <sub>j</sub> = 25°C		4 / 8	62 / 124	μA
		V <sub>R</sub> = 1200V, T <sub>j</sub> = 150°C		22 / 44	320 / 640	

**Dynamic Characteristics, at T<sub>j</sub>=25°C, unless otherwise specified**

Parameter	Symbol	Conditions	Value (leg/device)			Unit
			min.	typ.	max.	
Total capacitive charge	Q <sub>C</sub>	V <sub>R</sub> = 800V, T <sub>j</sub> = 150°C & 25°C $Q_C = \int_0^{V_R} C(V) dV$	-	41 / 82	-	nC
Total Capacitance	C	V <sub>R</sub> = 1 V, f = 1 MHz	-	525 / 1050	-	pF
		V <sub>R</sub> = 400 V, f = 1 MHz	-	37 / 74	-	
		V <sub>R</sub> = 800 V, f = 1 MHz	-	29 / 59	-	

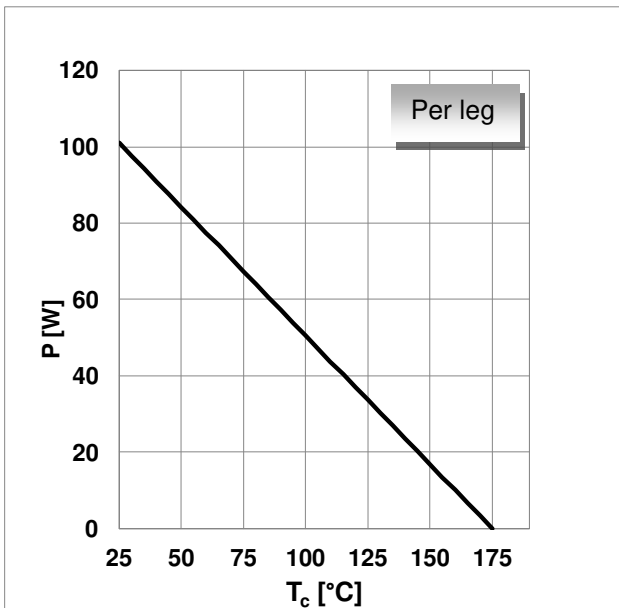

Figure 1. Power dissipation per leg as function of case temperature,  $P_{tot}=f(T_C)$ ,  $R_{th(j-c),max}$

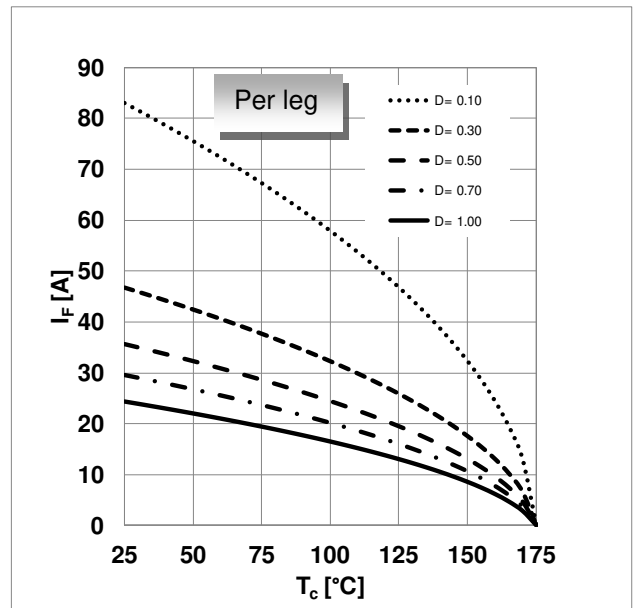

Figure 2. Diode forward current per leg as function of temperature, parameter:  $T_j \leq 175^\circ\text{C}$ ,  $R_{th(j-c),max}$ ,  $D$ =duty cycle,  $V_{th}$ ,  $R_{diff}$  @  $T_j=175^\circ\text{C}$

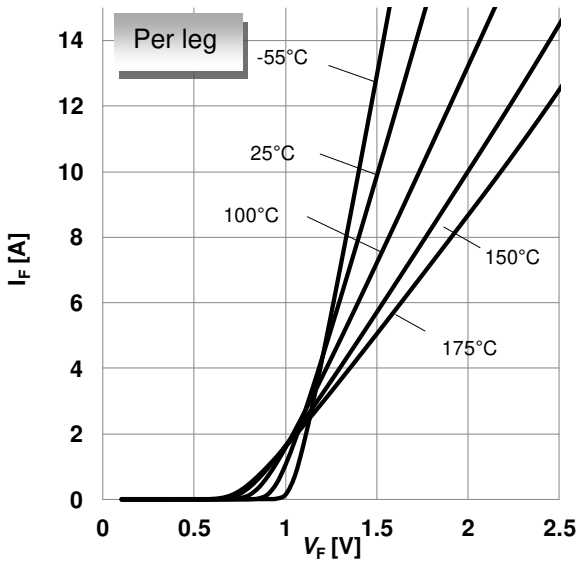

Figure 3. Typical forward characteristics per leg,  $I_F=f(V_F)$ ,  $t_p=10\ \mu\text{s}$ , parameter:  $T_j$

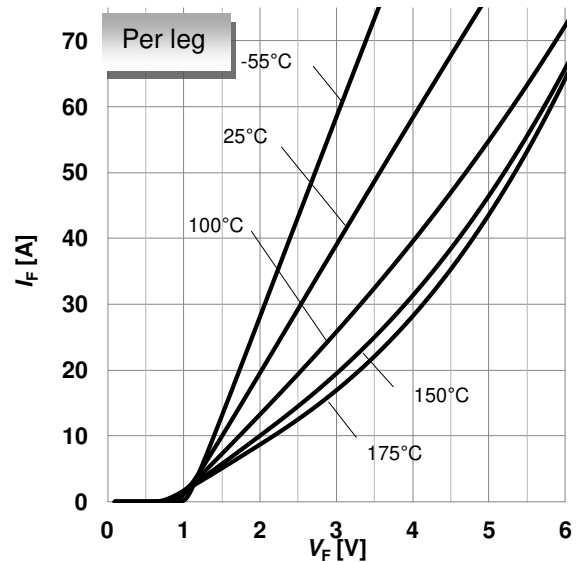

Figure 4. Typical forward characteristics in surge current per leg,  $I_F=f(V_F)$ ,  $t_p=10\ \mu\text{s}$ , parameter:  $T_j$

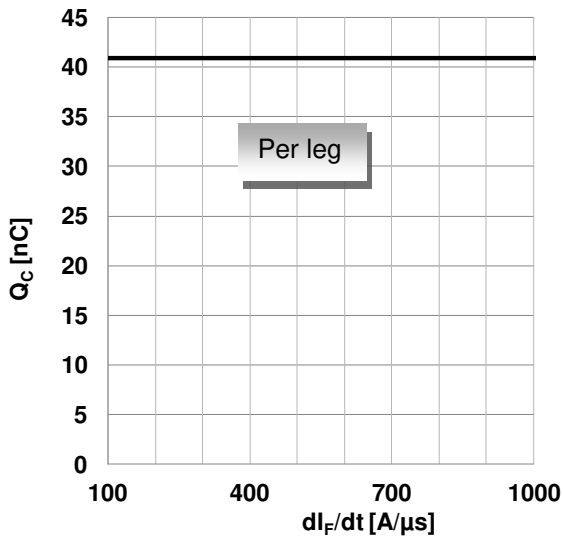

Figure 5. Typical capacitive charge per leg as function of current slope<sup>1</sup>,  $Q_C=f(di_F/dt)$ ,  $T_j=150^\circ\text{C}$   
 1) guaranteed by design.

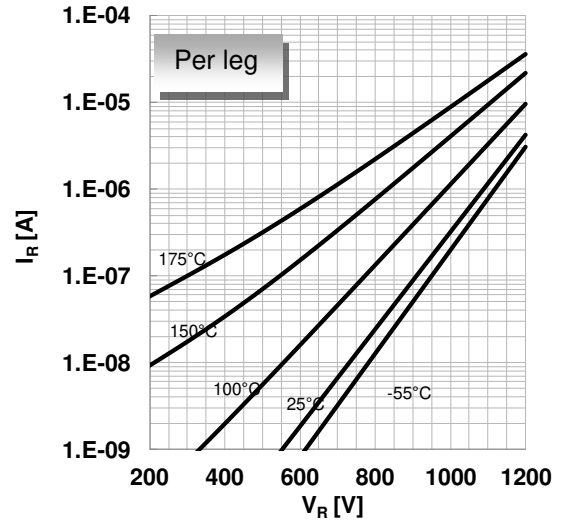

Figure 6. Typical reverse characteristics per leg,  $I_R=f(V_R)$ , parameter:  $T_j$

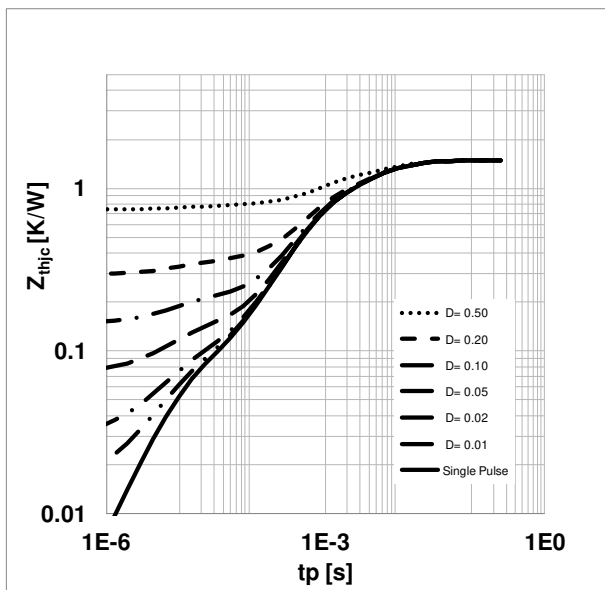

Figure 7. Max. transient thermal impedance per leg,  $Z_{th,jc}=f(t_p)$ , parameter:  $D=t_p/T$

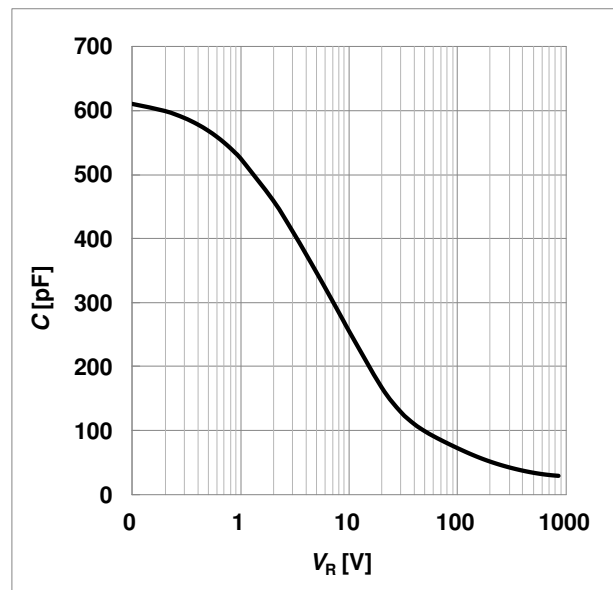

Figure 8. Typical capacitance per leg as function of reverse voltage,  $C=f(V_R)$ ;  $T_j=25^\circ\text{C}$ ;  $f=1\text{ MHz}$



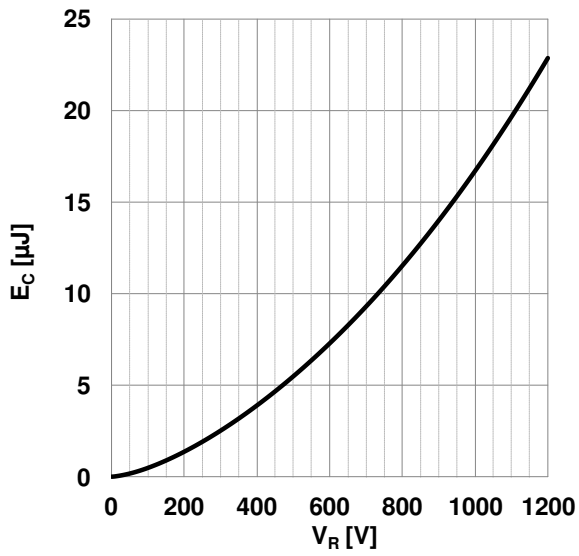
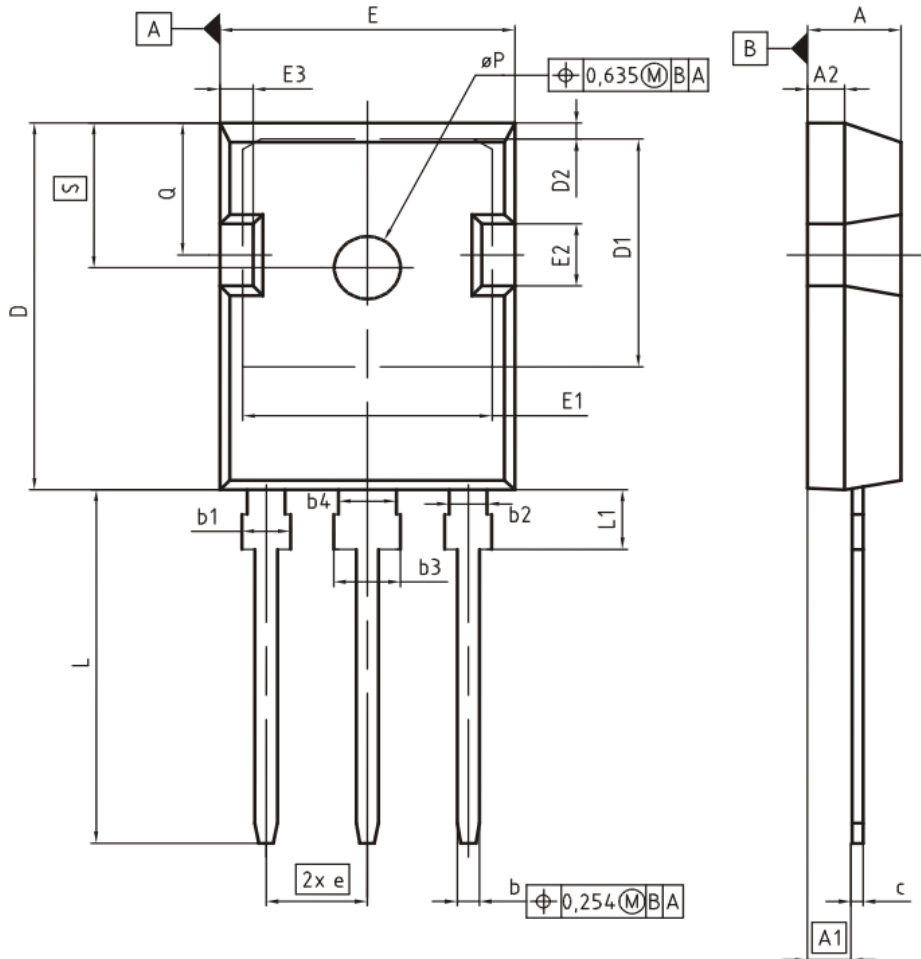

Figure 9. Typical capacitively stored energy as function of reverse voltage, per leg,  $E_C=f(V_R)$

PG-TO247-3



DIM	MILLIMETERS		INCHES	
	MIN	MAX	MIN	MAX
A	4.83	5.21	0.190	0.205
A1	2.27	2.54	0.089	0.100
A2	1.85	2.16	0.073	0.085
b	1.07	1.33	0.042	0.052
b1	1.90	2.41	0.075	0.095
b2	1.90	2.16	0.075	0.085
b3	2.87	3.38	0.113	0.133
b4	2.87	3.13	0.113	0.123
c	0.55	0.68	0.022	0.027
D	20.80	21.10	0.819	0.831
D1	16.25	17.65	0.640	0.695
D2	0.95	1.35	0.037	0.053
E	15.70	16.13	0.618	0.635
E1	13.10	14.15	0.516	0.557
E2	3.68	5.10	0.145	0.201
E3	1.00	2.60	0.039	0.102
e	5.44 (BSC)		0.214 (BSC)	
N	3		3	
L	19.80	20.32	0.780	0.800
L1	4.10	4.47	0.161	0.176
$\phi P$	3.50	3.70	0.138	0.146
Q	5.49	6.00	0.216	0.236
S	6.04	6.30	0.238	0.248

**DOCUMENT NO.**  
Z8B00003327

**SCALE**

**EUROPEAN PROJECTION**

**ISSUE DATE**  
09-07-2010

**REVISION**  
05

## Revision History

IDW15G120C5B

### Revision: 2014-06-10, Rev. 2.0

Previous Revision:

Revision	Date	Subjects (major changes since last version)
2.0	-	Final data sheet

### We Listen to Your Comments

Any information within this document that you feel is wrong, unclear or missing at all?

Your feedback will help us to continuously improve the quality of this document.

Please send your proposal (including a reference to this document) to: [erratum@infineon.com](mailto:erratum@infineon.com)

### Published by

**Infineon Technologies AG**

**81726 Munich, Germany**

**© 2014 Infineon Technologies AG**

**All Rights Reserved.**

### Legal Disclaimer

The information given in this document shall in no event be regarded as a guarantee of conditions or characteristics. With respect to any examples or hints given herein, any typical values stated herein and/or any information regarding the application of the device, Infineon Technologies hereby disclaims any and all warranties and liabilities of any kind, including without limitation, warranties of non-infringement of intellectual property rights of any third party.

### Information

For further information on technology, delivery terms and conditions and prices, please contact the nearest Infineon Technologies Office ([www.infineon.com](http://www.infineon.com)).

### Warnings

Due to technical requirements, components may contain dangerous substances. For information on the types in question, please contact the nearest Infineon Technologies Office.

The Infineon Technologies component described in this Data Sheet may be used in life-support devices or systems and/or automotive, aviation and aerospace applications or systems only with the express written approval of Infineon Technologies, if a failure of such components can reasonably be expected to cause the failure of that life-support, automotive, aviation and aerospace device or system or to affect the safety or effectiveness of that device or system. Life support devices or systems are intended to be implanted in the human body or to support and/or maintain and sustain and/or protect human life. If they fail, it is reasonable to assume that the health of the user or other persons may be endangered.